

# Mechanics Tool Guide

2020 Catalogue



Mechanics First Choice For 85 Years



**FRANKLIN**  
Professional Quality Tools

"One of our key design rules is to focus to provide a quicker solution that performs first time and lasts a lifetime"

## Dedication

Supplying quality hand tools to the Trade for automotive and technical use by the professional mechanic and DIY enthusiast since 1935.

## Customer Satisfaction

Our commitment to providing customers with excellent personal service and quality products at competitive prices remains as strong as ever.

## Product Range

We aim to hold extensive finished stocks to provide a high level of order completion, prompt deliveries and good continuity of supply. From sockets and spanners to engine timing sets and air tools, inspection lights and safety protection you can find them all in the catalogue and website. If you can't see what you are looking for, just call us on 0114 272 1429 and we will try to help you.

## Quality

We know our customers expect quality and longevity from their tools. We are confident our products stand the test of time and deliver customer satisfaction.

## Innovation

We listen to our customers and visit several national and international trade shows each year. We are constantly developing new products to be added to the range.

## Product Belief

All Franklin Tools are unconditionally guaranteed for twelve months against faulty materials or workmanship. Better still. Our new GearF range has a lifetime guarantee. Great care is taken to ensure that the most appropriate materials are selected and strict quality controls are applied at every stage of manufacture.

## FF Franklin & Co Ltd

Platt Street

Sheffield

S3 8BQ

England

### Telephone

0114 272 1429

### Facsimile

0114 272 7030

### Email

orders@franklin-tools.co.uk

### Website

www.franklin-tools.co.uk



"One of our key design rules is to focus to provide a quicker solution that performs first time and lasts a lifetime"

## Tools in EVA Modules

Storage Solutions	A
XF Socketry	B
Gear F Range with Lifetime Warranty	C
Spanners	
Pliers	
Screwdrivers	
AF Series	D
Spanners	
Hand Tools	
Automotive	

## All Tools

Socketry	E
Spanners	F
Screwdrivers	G
Pliers	H
Metal Working	I
Hand Tools	J
Lights	K
Air Tools	L
Power Tools	M
Test Tools	N
Powertrain	O
Drivetrain	P
Body Tools	Q
Protection	R
Timing Sets	S
Product Index	T
Part No. Index	U





- Tool Features**
- Efficient Modular Storage System
  - Easy Tool Selection
  - High Visibility Size Markings
  - Finest Quality Steels: Chrome Vanadium, Chrome Molybdenum, S2 Steel
  - Mirror Finish – Anti Slip Knurl
  - Manufactured to Din Standards

Part No. RF42TB  
Image for reference only

**Tool Box Specifications**

- Overall Storage 5.4 Metres x 400mm
- 10 drawers complete with aluminum drawer pull
- Lined with 2.5mm thick EVA
- 5 x 580 x 400 x 75mm, 5 x 301 x 400 x 75mm
- Lift up lid storage 1000 x 400mm
- Anti tip safe system, only allows single drawer opening
- High-end ball bearing slides with safe lock function
- Pair of Gas Struts
- Two Side Handles
- Lock and 2 keys
- Electro Powder Coating
- Packaging Poly bag + protective foam + export carton + pallet
- Overall size 1042(W) x 450(D) x 540(H)mm
- Weight 52 Kilos, Packaged Weight 56 Kilos

# Starter Kit - Top Box

Franklin 42" 10 Drawer Top Box Starter Kit 295 Pieces  
TK4TS1



**Kit Includes**

**Drawer 1**

Part No.	Description
XF1013	Franklin XF 13 pce 6 pt Socket Set 1/4" dr
XF3018	Franklin XF 18 pce 6 pt Socket Set 3/8" dr
XF5018	Franklin XF 18 pce 12 pt Socket Set 3/8" dr
XFR372	Franklin XF 3 pce 72 Teeth Ratchet Set 1/4" 3/8" 1/2" dr
XFA16	Franklin XF 16 pce Bit Holder & Socket Adaptor Set
XFSD9	Franklin XF 9 pce Screwdriver Bit Socket Set 3/8" dr
XFS10	Franklin XF 10 pce Star Bit Socket Set 3/8" dr
XFXS7	Franklin XF 7 pce Spline Bit Socket Set 3/8" dr
XFH09	Franklin XF 9 pce Hexagon Bit Socket Set 3/8" dr

**Drawer 1A**

Part No.	Description
XF1466	Franklin XF 6 pce Extension Bar Set 1/4" dr
XF3865	Franklin XF 5 pce Extension Bar Set 3/8" dr
XF1265	Franklin XF 5 pce Extension Bar Set 1/2" dr

**Drawer 2**

Part No.	Description
XFH11	Franklin XF 11 pce Hexagon Bit Socket Set 1/2" dr
XFE14	Franklin XF 14 pce External Star Socket Set 1/4" 3/8" 1/2" dr
XFHL9	Franklin XF 9 pce Long Hexagon Bit Socket Set 3/8" dr
XFLS10	Franklin XF 10 pce Low Profile Star Socket Set 3/8" dr
XFLH9	Franklin XF 9 pce Low Profile Hexagon Socket Set 3/8" dr
XF4019	Franklin XF 19 pce 6 pt Deep Socket Set 3/8" dr
XF6017	Franklin XF 17 pce 6 pt Socket Set 1/2" dr
XF7013	Franklin XF 13 pce 6 pt Deep Socket Set 1/2" dr

**Drawer 2A**

Part No.	Description
XFL12	Franklin XF 12 pce 12 pt Low Profile Socket Set 3/8" dr
XFLX7	Franklin XF 7 pce Low Profile Spline Set 3/8" dr
XFSL7	Franklin XF 7 pce Long Star Bit Socket Set 3/8" dr
XF027	Franklin XF 27 pce Bit Socket Set 1/4" dr
XF2010	Franklin XF 10 pce 6 pt Deep Socket Set 1/4" dr
AFB01	Franklin XF 10 pce Impact Bolt Extractor Set 3/8" dr

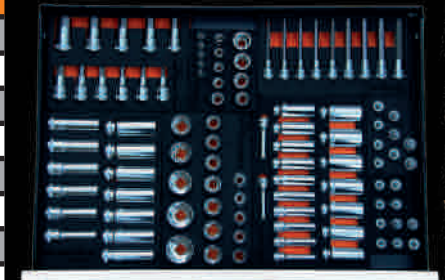
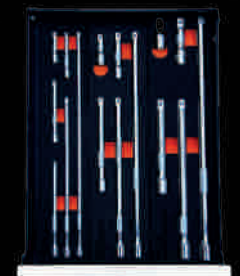





Part No. **RF42RC**  
Image for reference only

**Tool Features**

- Efficient Modular Storage System
- Easy Tool Selection
- High Visibility Size Markings
- Finest Quality Steels: Chrome Vanadium, Chrome Molybdenum, S2 Steel
- Mirror Finish – Anti Slip Knurl
- Manufactured to Din Standards

**Tool Box Specifications**

- Overall Storage 7.26 Metres x 400mm
- 14 drawers complete with aluminum drawer pull
- Lined with 2.5mm thick EVA
- 2 x 944 x 400 x 68mm,
- 5 x 580 x 400 x 75mm, 5 x 301 x 400 x 75mm
- 1 x 580 x 400 x 154mm, 1 x 301 x 400 x 154mm
- High-end ball bearing slides with safe lock function
- Anti tip safe system, only allows single drawer opening
- Steel side handle
- Lock and 2 keys
- 5" x 2" TPR casters, two fixed, two swivel with brakes
- Electro Powder Coating
- Packaging: Poly bag + protective foam + export carton + pallet
- Overall size: 1052 X 460 X 1030mm (with wheels)
- Weight 92 Kilos, Packaged Weight 97 Kilos

# Starter Kit - Roll Cab

Franklin 42" 14 Drawer Roll Cab Starter Kit 76 Pieces  
TK4RS1



**Kit Includes**

**Drawer 1**

Part No.	Description
GF308	Gear F 3pce 8" Plier Set
GF311	Gear F 3 pce 11" Long Reach Plier Set
AF7300	Gear F Grip 4+ 10 pce 12 pt Combination Ratchet Spanner Set
AF7100	Gear F Grip 4+ 10 pce 12 pt XL Combination Spanner Set
AF7200	Gear F 10 pce 12 pt Stubby Ratchet Spanner Set
AF2702	Franklin 10 pce 12 pt Stubby Spanner Set

**Drawer 2**

Part No.	Description
GFS2T	Gear F 6 pce Star S2 PRO Screwdriver Set
GFS2F	Gear F 6 pce Flat S2 PRO Screwdriver Set
GFS2P	Gear F 6 pce Phillips & Pozi S2 PRO Screwdriver Set
AF2805	Franklin 5 pce Flexible Nut Spinner Set

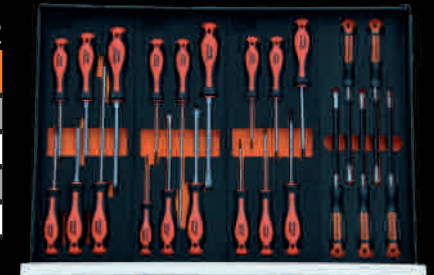

**Drawer 2A**

Part No.	Description
GFGJ1	Gear F 3 pce Grip-Jaw Plier Set
GFW3	Gear F 3 pce Wire Stripper Set in EVA



**Drawer 1**





# Starter Kit - Combination

Franklin 42" 24 Drawer Starter Kit Combination Kit  
371 Pieces Top Box and Roll Cab  
TK4CS1

**Kit Includes**

See pages A4-A7 for further information on the contents



Top Box Includes



Roll Cab Includes



**Tool Features**

- Efficient Modular Storage System
- Easy Tool Selection
- High Visibility Size Markings
- Finest Quality Steels: Chrome Vanadium, Chrome Molybdenum, S2 Steel
- Mirror Finish – Anti Slip Knurl
- Manufactured to Din Standards

Part No. RF42D  
Image for reference only



## Tool Box Specifications

- Overall Storage 8.06 Metres x 400mm
- High quality stainless steel body
- Heavy duty solid wood work bench
- 15 drawers with heavy duty roller bearings
- Drawers lined with Non-Slip rubber sheet
- Latch free locking mechanism
- Tubular locks
- Heavy duty 6" rubber castor wheels, including brakes
- Side handles
- Weight 130kg



Part No. **RST72**  
Image for reference only

## Tool Features

- Efficient Modular Storage System
- Easy Tool Selection
- High Visibility Size Markings
- Finest Quality Steels: Chrome Vanadium, Chrome Molybdenum, S2 Steel
- Mirror Finish – Anti Slip Knurl
- Manufactured to Din Standards

# Intermediate Kit

Franklin 72" 15 Drawer Stainless Steel  
Tool Kit 650 Pieces  
TK7201 (TK7200 Tools Only)



Search TK7201 at [www.franklin-tools.co.uk](http://www.franklin-tools.co.uk) for more information





Part No. RF42TB  
Image for reference only

**Tool Features**

- Efficient Modular Storage System
- Easy Tool Selection
- High Visibility Size Markings
- Finest Quality Steels: Chrome Vanadium, Chrome Molybdenum, S2 Steel
- Mirror Finish – Anti Slip Knurl
- Manufactured to Din Standards

**Tool Box Specifications**

- Overall Storage 5.4 Metres x 400mm
- 10 drawers complete with aluminum drawer pull
- Lined with 2.5mm thick EVA
- 5 x 580 x 400 x 75mm, 5 x 301 x 400 x 75mm
- Lift up lid storage 1000 x 400mm
- Anti tip safe system, only allows single drawer opening
- High-end ball bearing slides with safe lock function
- Pair of Gas Struts
- Two Side Handles
- Lock and 2 keys
- Electro Powder Coating
- Packaging Poly bag + protective foam + export carton + pallet
- Overall size 1042(W) x 450(D) x 540(H)mm
- Weight 52 Kilos, Packaged Weight 56 Kilos

# Master Kit - Top Box

Franklin 42" 10 Drawer Top Box Master Kit 584 Pieces  
TK4TM1



**Kit Includes**

**Lid Storage Part No: TK4T0**

Part No.	Description
GF316	Gear F 3 pce 16" Long Reach Plier Set
AF7101	Gear F Grip 4+ 7 pce 12 pt XL Combination Spanner Set
XFA100	Franklin 4 pce Power Bar / Extension Bar Set
XFHL9	Franklin XF 9 pce Long Hexagon Bit Socket Set 3/8" dr



**Drawer 1 Part No: TK4T1**

Part No.	Description
XF1476	Franklin XF 6 pce Two Stage Wobble and Fixed Extension Bar Set 1/4" dr
XF1496	Franklin XF 6 pce Impact Extension Bar Set 1/4" dr
XF1466	Franklin XF 6 pce Extension Bar Set 1/4" dr
XF3895	Franklin XF 5 pce Impact Extension Bar Set 3/8" dr
XF2010	Franklin XF 10 pce 6 pt Deep Socket Set 1/4" dr
XF027	Franklin XF 27 pce Bit Socket Set 1/4" dr
XFPE12	Franklin XF 12 pce Low Profile External Star Set 3/8" dr
XFM13	Franklin XF 13 pce Multi-Drive Socket Set 1/4" dr
XF1013	Franklin XF 13 pce 6 pt Socket Set 1/4" dr

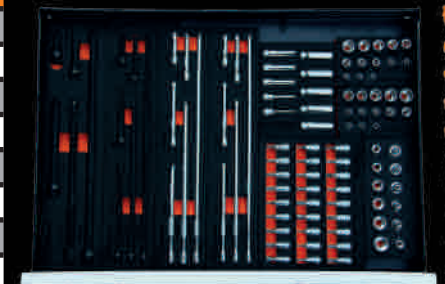

**Drawer 1A Part No: TK4T1A**

Part No.	Description
AF2704	Franklin 4 pce Star Ring Spanner Set
XFA16	Franklin XF 16 pce Bit Holder & Socket Adaptor Set
XFR372	Franklin XF 3 pce 72 Teeth Ratchet Set 1/4" 3/8" 1/2" dr



**Drawer 2 Part No: TK4T2**

Part No.	Description
XF4019	Franklin XF 19 pce 6 pt Deep Socket Set 3/8" dr
XFXS7	Franklin XF 7 pce Spline Bit Socket Set 3/8" dr
XFS10	Franklin XF 10 pce Star Bit Socket Set 3/8" dr
XFLO6	Franklin XF 6 pce 6 pt Low Profile Filter Socket Set 3/8" dr
XFDP18	Franklin XF 18 pce Drain Plug Key Set 3/8" dr
XFLH9	Franklin XF 9 pce Low Profile Hexagon Socket Set 3/8" dr
XFLS10	Franklin XF 10 pce Low Profile Star Socket Set 3/8" dr
XF5018	Franklin XF 18 pce 12 pt Socket Set 3/8" dr
XF3018	Franklin XF 18 pce 6 pt Socket Set 3/8" dr
XFE14	Franklin XF 14 pce External Star Socket Set 1/4" 3/8" 1/2" dr



Contents continue overleaf..





Part No. RF42TB  
Image for reference only

**Drawer 2A Part No: TK4T2A**

Part No.	Description
XFR3E	Franklin XF 3 pce 72 Teeth Extending Ratchet Set 1/4" 3/8" 1/2" dr
XFR3F	Franklin XF 3 pce 72 Teeth Flexi Extending Ratchet Set 1/4" 3/8" 1/2" dr



**Drawer 3 Part No: TK4T3**

Part No.	Description
XFSD9	Franklin XF 9 pce Screwdriver Bit Socket Set 3/8" dr
XFH09	Franklin XF 9 pce Hexagon Bit Socket Set 3/8" dr
XFM19	Franklin XF 19 pce Multi-Drive Socket Set 3/8" dr
XFYH9	Franklin XF 9 pce 200mm Long Hexagon Bit Socket Set 3/8" dr
XFYS8	Franklin XF 8 pce 200mm Long Star Bit Socket Set 3/8" dr
AF7396	Franklin 6 pce Adaptor Drive Set for Ratchet Spanner
XFLT8	Franklin XF 8 pce Low Profile Tamper Star Socket Set 3/8" dr
XFSL7	Franklin XF 7 pce Long Star Bit Socket Set 3/8" dr
XFTS8	Franklin XF 8 pce Tamper Star Bit Socket Set 3/8" dr

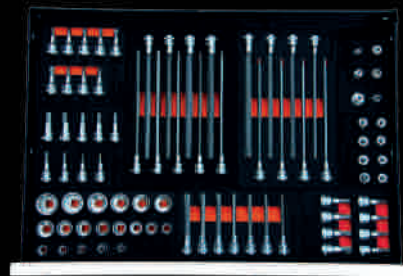

**Drawer 3A Part No: TK4T3A**

Part No.	Description
XFRS10	Franklin XF 10 pce Ribe Bit Socket Set 3/8" 1/2" dr
XFRL8	Franklin XF 8 pce Long Ribe Bit Socket Set 3/8" 1/2" dr
XFBH9	Franklin XF 9 pce Hexagon Long Ball End Bit Socket Set 3/8" dr



# Master Kit - Top Box Continued

Franklin 42" 10 Drawer Top Box Master Kit 584 Pieces  
TK4TM1



## Kit Includes

**Drawer 4 Part No: TK4T4**

Part No.	Description
XF3865	Franklin XF 5 pce Extension Bar Set 3/8" dr
XF3875	Franklin XF 5 pce Two Stage Wobble and Fixed Extension Bar Set 3/8" dr
XFYBH9	Franklin XF 9 pce 200mm Hexagon Long Ball End Bit Socket Set 3/8" dr
XFAS4	Franklin XF 4 pce Alloy Wheel Nut Socket Set 1/2" dr
XFL12	Franklin XF 12 pce 12 pt Low Profile Socket Set 3/8" dr
XFIS10	Franklin XF 10 pce Impact Star Bit Socket Set 3/8" dr
XFIH10	Franklin XF 10 pce Impact Hexagon Bit Socket Set 3/8" dr



**Drawer 4A Part No: TK4T4A**

Part No.	Description
XFEL14	Franklin XF 14 pce External Star Deep Socket Set 1/4" 3/8" 1/2" dr
XFIX4	Franklin 4 pce Impact Spline Bit Set 1/2" dr
AF2124	Franklin 4 pce Stud Extractor Set 1/2" dr
XFTSP7	Franklin 7 pce Star Plus Bit Set 1/4" dr
XFTSL8	Franklin XF 8 pce Long Tamper Star Bit Socket Set 3/8" dr



**Drawer 5 Part No: TK4T5**

Part No.	Description
XF1295	Franklin XF 5 pce Impact Extension Bar Set 1/2" dr
XF1275	Franklin XF 5 pce Two Stage Wobble and Fixed Extension Bar Set 1/2" dr
XF1265	Franklin XF 5 pce Extension Bar Set 1/2" dr
XF7013	Franklin XF 13 pce 6 pt Deep Socket Set 1/2" dr
XF6017	Franklin XF 17 pce 6 pt Socket Set 1/2" dr
XFLR10	Franklin XF 10 pce Low Profile Ribe Set 3/8" dr
XFLX7	Franklin XF 7 pce Low Profile Spline Set 3/8" dr



**Drawer 5A Part No: TK4T5A**

Part No.	Description
XFSL6	Franklin XF 6 pce Long Star Bit Socket Set 1/2" dr
XFH11	Franklin XF 11 pce Hexagon Bit Socket Set 1/2" dr
XF8023	Franklin XF 23 pce 12 pt Socket Set 1/2" dr







Part No. RF42RC  
Image for reference only

**Kit Includes**

**Drawer 1 Part No: TK4R1**

Part No.	Description
GF308	Gear F 3pce 8" Plier Set
GF311	Gear F 3 pce 11" Long Reach Plier Set
GF313	Gear F 3 pce 13" Compound Joint Long Reach Plier Set
GF407	Gear F 4 pce 7" Circlip Plier Set
AF2023	Franklin 3 pce Hose Clamp Set
GFW3	Gear F 3 pce Wire Stripper Set



# Master Kit - Roll Cab

Franklin 42" 14 Drawer Roll Cab Master Kit 382 Pieces

TK4RM1



**Drawer 2 Part No: TK4R2**

Part No.	Description
AF7305	Gear F Grip 4+ 5 pce 12 pt Combination Ratchet Spanner Set
AF7105	Gear F Grip 4+ 5 pce 12 pt XL Combination Spanner Set
AF7100	Gear F Grip 4+ 10 pce 12 pt XL Combination Spanner Set
AF7300	Gear F Grip 4+ 10 pce 12 pt Combination Ratchet Spanner Set
AF7304	Gear F Grip 4+ 4 pce 12 pt Combination Ratchet Spanner Set
AF7200	Gear F 10 pce 12 pt Stubby Ratchet Spanner Set
AF2702	Franklin 10 pce 12 pt Stubby Spanner Set

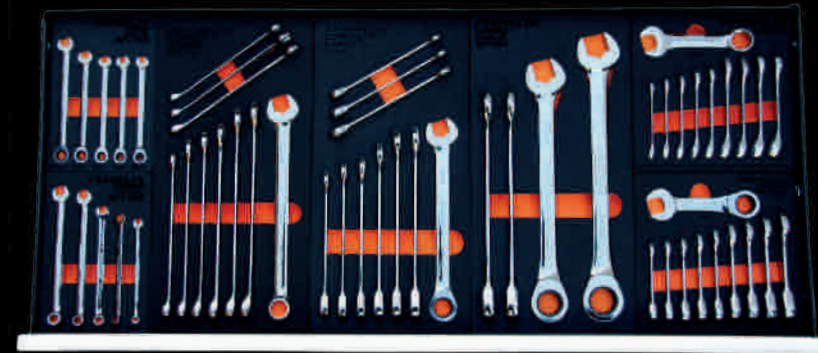

**Drawer 3 Part No: TK4R3**

Part No.	Description
GFGJ1	Gear F 3 pce Grip-Jaw Plier Set
GFGJ2	Gear F 3 pce Grip Jaw Plier Set
GFGJ3	Gear F 3 pce Grip-Jaw Plier Mechanics Set
XFRF2	Franklin XF 2 pce 72 Teeth Low Profile Flexible Ratchet Set 1/4" 3/8" dr



**Drawer 3A Part No: TK4R3A**

Part No.	Description
AF7950	GearF 10 pce 12pt Crowfoot Wrench Set 3/8" dr
AF7970	GearF 7 pce 12pt Crowfoot Wrench Set 1/2" dr
XFI4LP	Franklin XF 17 pce 6 pt Low Profile Impact Socket Set 1/2" dr
XFI5LP	Franklin XF 16 pce 6 pt Low Profile Impact Socket Set 3/8" dr



Contents continue overleaf..





Part No. **RF42RC**  
Image for reference only

### Tool Features

- Efficient Modular Storage System
- Easy Tool Selection
- High Visibility Size Markings
- Finest Quality Steels: Chrome Vanadium, Chrome Molybdenum, S2 Steel
- Mirror Finish – Anti Slip Knurl
- Manufactured to Din Standards

### Drawer 4 Part No: TK4R4

Part No.	Description
GFS2T	Gear F 6 pce Star S2 PRO Screwdriver Set
GFS2P	Gear F 6 pce Phillips & Pozi S2 PRO Screwdriver Set
GFS2F	Gear F 6 pce Flat S2 PRO Screwdriver Set
AF2029	Franklin 4 pce Large Hook and Pick Set



### Drawer 4A Part No: TK4R4A

Part No.	Description
XFI200	Franklin XF 6 pce Impact Adaptor Set
XFB010	Franklin XF 10 pce Bolt Extractor Set 3/8" dr
XFI6SD	Franklin XF 14 pce 6 pt Semi Deep Thin Wall Impact Socket Set 3/8" dr
XFI7SD	Franklin XF 7 pce 6 pt Semi Deep Thin Wall Impact Socket Set 1/2" dr
XFI8SD	Franklin XF 8 pce 6 pt Semi Deep Thin Wall Impact Socket Set 1/2" dr



### Drawer 5 Part No: TK4R5

Part No.	Description
AF2024	Franklin 4 pce Door Panel Remover Set
AF2027	Franklin 7 pce Hook and Pick Set
AF2803	Franklin 3 pce Flexible Driver Set
AF2805	Franklin 5 pce Flexible Nut Spinner Set

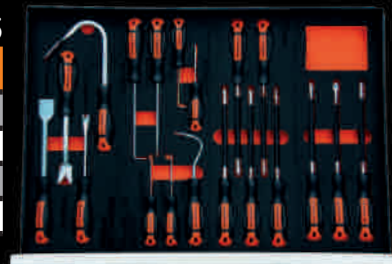

### Drawer 5A Part No: TK4R5A

Part No.	Description
XFI300	Franklin XF 3 pce Impact Universal Joint Set 1/4" 3/8" 1/2" dr
AF7505	Gear F 5 pce 12 pt Flexi Ratchet Combination Spanner Set
XFAS6	Franklin XF 6 pce 6 pt Alloy Wheel Nut Socket Set 1/2" dr
AFB01	Franklin XF 10 pce Impact Bolt Extractor Set 3/8" dr
AFBW6	Franklin 6 pce Wheel Bolt Extractor Set 1/2" dr



# Master Kit - Roll Cab continued

## Franklin 42" 14 Drawer Roll Cab Master Kit 382 Pieces TK4RM1



### Kit Includes

#### Drawer 6 Part No: TK4R6

Part No.	Description
AF2701	Franklin 8 pce 12 pt Ring Spanner Set
AF7600	Gear F 12 pce 12 pt Reversible Ratchet Combination Spanner Set
AF7500	Gear F 10 pce 12 pt Flexi Ratchet Combination Spanner Set



#### Drawer 6A Part No: TK4R6A

Part No.	Description
AF1718	Franklin 18 pce Star and Hexagon Angle Wrench Set
AF1703	Franklin 3 pce Scraper Set



#### Drawer 7 Part No: TK4R7

Part No.	Description
AF2709	Franklin 4 pce Adjustable Wrench Set 6 8 10 12"
AF1720	Franklin 6 pce Soft Grip Handled File Set 8"
AF1713	Franklin 13 pce Chisel and Punch Set



#### Drawer 7A Part No: TK4R7A

Part No.	Description
GFDP6	Gear F 6 pce Diamond Power Grip Screwdriver Set
AF7900	Gear F 13 pce Crowfoot Wrench Set 3/8" dr

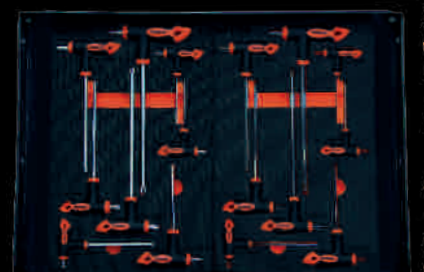

#### Drawer 8 Part No: TK4R8

Part No.	Description
AF1708	Franklin 8 pce Long Star T Handle Set
AF1709	Franklin 8 pce Long Hexagon T Handle Set



#### Drawer 8A Part No: TK4R8A

Part No.	Description
XFHL8	Franklin XF 8 pce Long Hexagon Bit Socket Set 1/2" dr
XFIH7	Franklin XF 7 pce Impact Hexagon Bit Socket Set 1/2" dr
XFIS7	Franklin XF 7 pce Impact Star Bit Socket Set 1/2" dr

Drawer 7A





See pages A12-A19 for further information on the contents

# Master Kit Combination

Franklin 42" 24 Drawer Master Combination Kit 966 Pieces Top Box and Roll Cab

TK4DM1

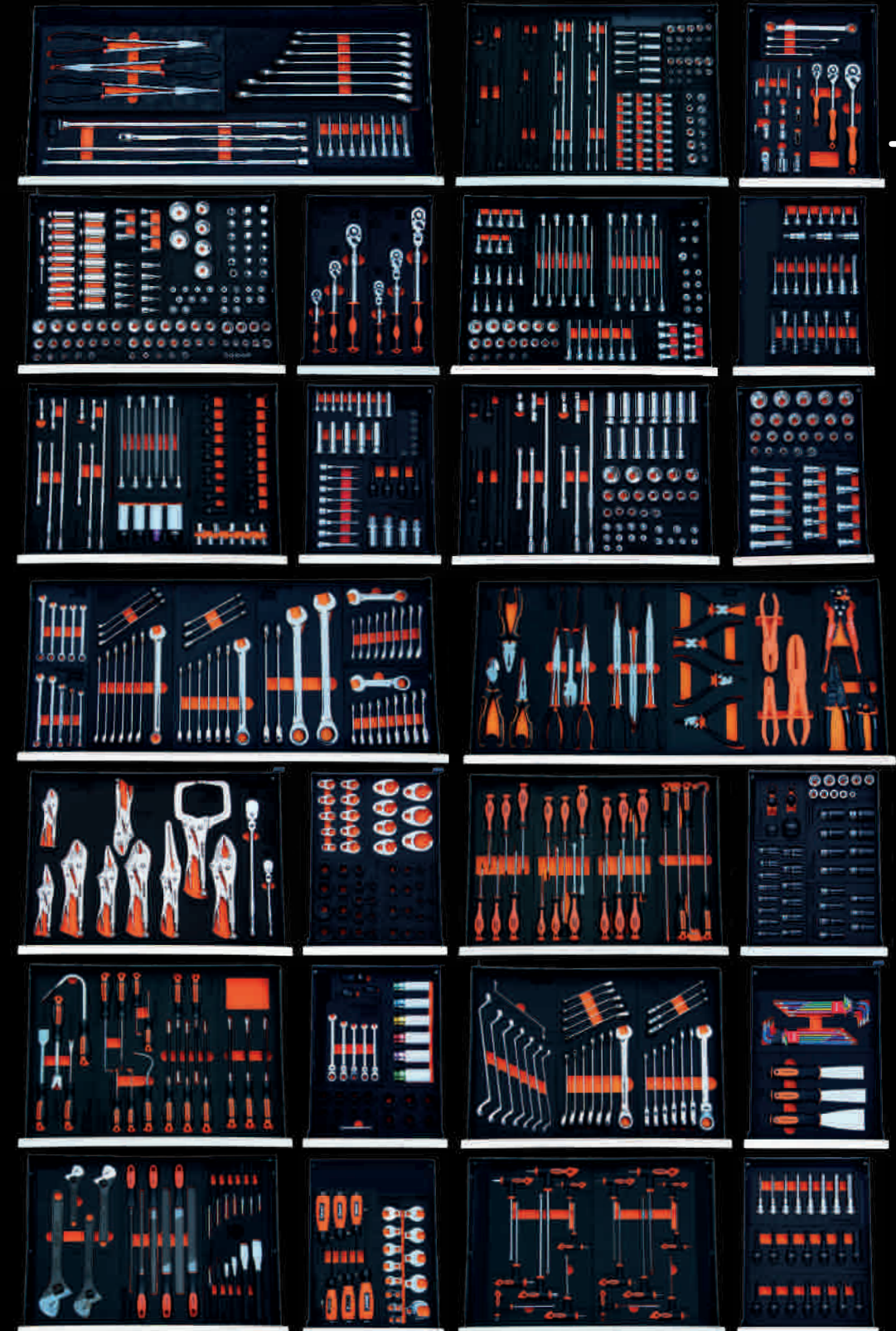

Top Box Includes

Roll Cab Includes

**Tool Features**

- Efficient Modular Storage System
- Easy Tool Selection
- High Visibility Size Markings
- Finest Quality Steels: Chrome Vanadium, Chrome Molybendum, S2 Steel
- Mirror Finish – Anti Slip Knurl
- Manufactured to Din Standards

Part No. RF42D  
Image for reference only



# Storage Solutions Build Your Own Tool Box

Storage Solutions

CHOOSE STORAGE



CHOOSE EVA DRAWER PACKS



APPLY FOR CREDIT



WE DO THE REST

Franklin Tools Build Your Own Tool Box allows end users to build their tool box in 3 simple steps.

To get started go to [www.franklin-tools.co.uk/modular-storage](http://www.franklin-tools.co.uk/modular-storage). Please ensure you are logged in prior to building your box. No account? No problem, you can sign up online.

1. Choose your **Storage** (optional).
2. Choose your **EVA Drawer packs**.
3. Finally Apply for **Franklin Credit**.

We do the rest and will be in contact soon. For more information please contact head office at 0114 272 1429, we will be happy to answer any of your questions.

**5S**  
**Sort**  
**Shine**  
**Sustain**  
**Set in Order**  
**Standardise**

We have an active program of adding EVA modules, please visit our website on a regular basis.

Additional Drawer Part No: TK4A1

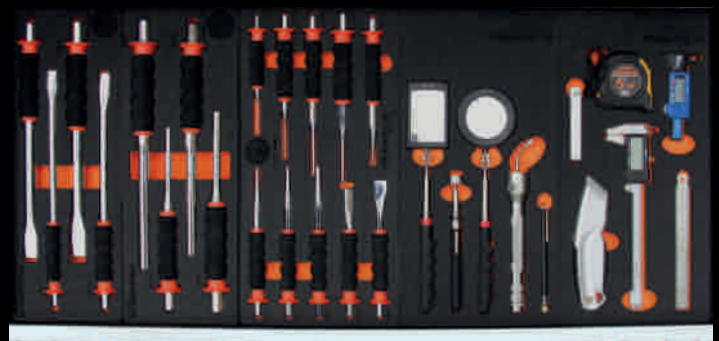

**FRANKLIN**  
Professional Quality Tools



# XF Socketry - B

## Contents

<b>Socket Sets</b>	<b>B2</b>
1/4" dr	B7
3/8" dr	B11
1/2" dr	B28
<b>Alloy Wheel Nut Sockets</b>	<b>B33</b>
<b>Bolt Extractors</b>	<b>B34</b>
<b>Impact</b>	<b>B37</b>
3/4" dr	B43
<b>Ratchets</b>	<b>B43</b>
<b>Extension Bars &amp; Accessories</b>	<b>B48</b>

**FF Franklin & Co Ltd**

Platt Street

Sheffield

S3 8BQ

England

**Telephone**

0114 272 1429

**Facsimile**

0114 272 7030

**Email**

orders@franklin-tools.co.uk

**Tools in EVA Modules**  
**2020**

**www.franklin-tools.co.uk**



**Franklin XF 179 pce Master Socket Set  
XF179**

**Features**

- High Grade Chrome Vanadium Steel Sockets
- S2 Steel Bits
- XF flank drive – 30% more torque
- Mirror Finish with Anti-Slip Knurl
- Manufactured to DIN Standards
- High Visibility Size Marking
- All Parts are available individually

**Contents**

- 7 - Hexagon Keys
- 1.27 1.5 2 2.5 3 4 5 mm
- 40 - Standard 6 pt XF Drive Sockets
- 4 4.5 5 5.5 6 7 8 9 10 11 12 13 14 mm x 1/4"
- 10 11 12 13 14 15 16 17 18 19 mm x 3/8"
- 10 11 12 13 14 15 16 17 18 19 mm x 1/2"
- 20 21 22 24 27 30 32 mm x 1/2"
- 16 - Deep 6 pt XF Drive Sockets
- 6 7 8 9 10 mm x 1/4"
- 10 11 12 13 14 15 mm x 3/8"
- 16 17 18 19 22 mm x 1/2"
- 28 - 1/4" x 25 mm Bits
- Ribe 5 6 7 8 9, Spline M5 M6 M8
- Star T5 T6 T7 T8 T9 T10 T15 T20 T25 T27 T30
- Star Plus TS8 TS10 TS15 TS20 TS25 TS27 TS30 TS40 TS45

- 24 - 5/16" x 30 mm Bits
- T40 T45 T50 T55 T60 T70, TP40 TP45 TP50 TP55 TP60 TP70
- PH3 PH4, PZ3 PZ4, SL8 SL10 SL12, Hexagon 7 8 10 12 14 mm

**13 - External Star Sockets**

- E4 E5 E6 E7 E8 x 1/4"
- E10 E11 E12 E14 x 3/8"
- E16 E18 E20 E24 x 1/2"

**17 - Accessories**

- Extension Bars 50 100 mm x 1/4"
- 150 mm x 3/8", 125 250 mm x 1/2"
- Bit Holder Adaptors 1/4" 3/8" 1/2"
- Spinner Handle 1/4"
- Sliding T piece 1/4" 1/2"
- 72 Teeth Reversible Ratchets 1/4" 3/8" 1/2"
- 3 - Deep 6 pt Spark Plug Sockets
- 18 mm (M12) x 3/8"
- 16 mm (M10), 21 mm (M14) x 1/2"

**30 - 1/4" Bit Sockets x 40 mm**

- T8 T9 T10 T15 T20 T25 T27 T30, TP8 TP9
- TP10 TP15 TP20 TP25 TP27 TP30
- PH0 PH1 PH2, PZ0 PZ1 PZ2
- SL4 SL5.5 SL6.5 SL7



**Franklin XF 20 pce 6 pt Socket Set 1/4" dr  
XF1020**

- Standard 6 pt XF Drive Sockets: 4 4.5 5 5.5 6 7 8 9 10 11 12 13 14mm
- 72 Teeth Reversible Ratchet
- Extension Bars 50 100 150mm
- Sliding T bar
- Universal Joint
- Go-through Spinner Handle

**Features**

- Tough Impact-resistant Carry Case
- High Grade Chrome Vanadium Steel
- XF flank drive – 30% more torque
- Mirror finish with Anti-Slip Knurl
- High Visibility Size Markings
- Supplied in industry approved EVA foam
- All Parts are available individually



**Franklin XF 27 pce 6 pt Socket Set 1/4" dr  
XF1027**

- Standard 6 pt XF Drive Sockets: 4 4.5 5 5.5 6 7 8 9 10 11 12 13 14mm
- Deep 6 pt XF Drive Sockets: 6 7 8 9 10 11 12 13mm
- 72 Teeth Reversible Ratchet
- Extension Bars 50 100 150mm
- Sliding T bar
- Universal Joint

**Features**

- Tough Impact-resistant Carry Case
- High Grade Chrome Vanadium Steel
- XF flank drive – 30% more torque
- Mirror finish with Anti-Slip Knurl
- High Visibility Size Markings
- Supplied in industry approved EVA foam
- All Parts are available individually





**Franklin XF 51 pce 6 pt Socket Set 1/4" dr**  
**XF1051**

- Standard 6 pt XF Drive Sockets: 4 4.5 5 5.5 6 7 8 9 10 11 12 13 14mm
- Screwdriver - SL4 SL5.5 SL7 - PZ1 PZ2 PZ3 - PH1 PH2 PH3
- Star - T10 T15 T20 T25 T27 T30 T40
- 12pt Spline - M4 M5 M6 M8 M10
- Hexagon - H3 H4 H5 H6 H7 H8
- Hexagon Keys - 1.27 1.5 2 2.5mm
- 72 Teeth Reversible Ratchet
- Extension Bars 50 100 150mm
- Sliding T bar
- Universal Joint
- Go-through Spinner Handle

**Features**

- High Grade Chrome Vanadium Steel Sockets
- S2 Bits
- XF flank drive – 30% more torque
- Mirror finish with Anti-Slip Knurl
- High Visibility Size Markings
- Tough Impact-resistant Carry Case
- All Parts are available individually



**Franklin XF 23 pce 6 pt Socket Set 3/8" dr**  
**XF3023**

- Standard 6 pt XF Drive Sockets: 6 7 8 9 10 11 12 13 14 15 16 17 18 19 20 21 22mm
- 72 Teeth Reversible Ratchet
- Extension Bars 75 150 200mm
- 3 way Adaptor 1/2" F x 3/8" M + Sliding T Head
- Universal Joint

**Features**

- High Grade Chrome Vanadium Steel
- Mirror finish with Anti-Slip Knurl
- XF flank drive – 30% more torque
- High Visibility Size Markings
- Tough Impact-resistant Carry Case
- Supplied in industry approved EVA foam
- All Parts are available individually



**Franklin XF 59 pce 6 pt Socket Set 1/4" dr**  
**XF1059**

- Standard 6 pt XF Drive Sockets: 4 4.5 5 5.5 6 7 8 9 10 11 12 13 14mm
- Deep 6 pt XF Drive Sockets: 6 7 8 9 10 11 12 13mm
- Screwdriver - SL4 SL5.5 SL7 - PZ1 PZ2 PZ3 - PH1 PH2 PH3
- Star - T10 T15 T20 T25 T27 T30 T40
- 12pt Spline - M4 M5 M6 M8 M10
- Hexagon - H3 H4 H5 H6 H7 H8
- Hexagon Keys - 1.27 1.5 2 2.5mm
- 72 Teeth Reversible Ratchet
- Extension Bars 50 100 150mm
- Sliding T bar
- Universal Joint
- 1/4" dr L-Handle Driver

**Features**

- High Grade Chrome Vanadium Steel Sockets
- S2 Bits
- XF flank drive – 30% more torque
- Mirror finish with Anti-Slip Knurl
- High Visibility Size Markings
- Tough Impact-resistant Carry Case
- All Parts are available individually



**Franklin XF 38 pce 6 pt Socket Set 3/8" dr**  
**XF3038**

- Standard 6 pt XF Drive Sockets: 6 7 8 9 10 11 12 13 14 15 16 17 18 19 20 21 22 23 24mm
- Deep 6 pt XF Drive Sockets: 8 9 10 11 12 13 14 15 16 17 18 19mm
- Deep 6 pt Spark Plug Sockets: 16mm (M10), 21mm (M14)
- 72 Teeth Reversible Ratchet
- Extension Bars 75 150mm
- 3 way Adaptor 1/2" F x 3/8" M + Sliding T Head
- Universal Joint

**Features**

- Tough Impact-resistant Carry Case
- High Grade Chrome Vanadium Steel
- Mirror finish with Anti-Slip Knurl
- XF flank drive – 30% more torque
- High Visibility Size Markings
- Supplied in industry approved EVA foam
- All Parts are available individually





**Franklin XF 27 pce 6 pt Socket Set 1/2" dr**  
**XF6027**

- Standard 6 pt XF Drive Sockets: 8 9 10 11 12 13 14 15 16 17 18 19 20 21 22 23 24 27 30 32mm
- Deep 6 pt Spark Plug Sockets: 16mm (M10), 21mm (M14)
- 72 Teeth Reversible Ratchet
- Extension Bars 75 250mm
- Universal Joint
- Sliding T bar

**Features**

- Tough Impact-resistant Carry Case
- High Grade Chrome Vanadium Steel
- Mirror finish with Anti-Slip Knurl
- XF flank drive - 30% more torque
- High Visibility Size Markings
- Supplied in industry approved EVA foam
- All Parts are available individually



**Franklin 13 pce Low Profile 6 pt Socket Set 1/4" dr**  
**XFL13**

4 4.5 5 5.5 6 7 8 9 10 11 12 13 14 x 17mm

**Features**

- High Grade Chrome Vanadium Steel
- Mirror finish with Anti-Slip Knurl
- XF flank drive - 30% more torque
- Manufactured to DIN Standards
- High Visibility Size Markings
- Supplied in industry approved EVA foam



**Franklin XF 21 pce 6pt Socket Set 3/4" dr**  
**XF3421**

19 21 22 24 27 28 29 30 32 33 35 36 38 41 46 50mm

- Extension Bars 100 200 400mm
- Reversible Ratchet, 450mm Sliding T bar

**Features**

- Chrome Vanadium Steel
- 6 Point Surface Drive
- Roll marked for easy identification
- Size Organised Storage Aids Tool Selection
- Tough Impact Resistant Carry Case



Part No.	Description
XL3419	19mm
XL3421	21mm
XL3422	22mm
XL3423	23mm Additional Size
XL3426	26mm Size Available
XL3427	27mm
XL3428	28mm
XL3429	29mm
XL3432	32mm
XL3433	33mm
XL3435	35mm
XL3436	36mm
XL3438	38mm
XL3441	41mm
XL3446	46mm
XL3450	50mm
FT3401	Reversible Ratchet
XL3404	100mm extension
XL3408	200mm extension
XL3416	400mm extension
XL3418	450mm Sliding T bar
FT3491	Ratchet Service Kit

**Franklin XF 13 pce 6 pt Socket Set 1/4" dr**  
**XF1013**

4 4.5 5 5.5 6 7 8 9 10 11 12 13 14mm x 24mm

**Features**

- High Grade Chrome Vanadium Steel
- Mirror finish with Anti-Slip Knurl
- XF flank drive - 30% more torque
- Manufactured to DIN Standards
- High Visibility Size Markings
- Supplied in industry approved EVA foam



Part No.	Description
XF104	4mm
XF1045	4.5mm
XF105	5mm
XF1055	5.5mm
XF106	6mm
XF107	7mm
XF108	8mm
XF109	9mm
XF110	10mm
XF111	11mm
XF112	12mm
XF113	13mm
XF114	14mm



**Franklin XF 10 pce 6 pt Deep Socket Set 1/4" dr**  
**XF2010**

4 5 6 7 8 9 10 11 12 13mm x 50mm

**Features**

- High Grade Chrome Vanadium Steel
- Mirror finish with Anti-Slip Knurl
- XF flank drive – 30% more torque
- Manufactured to DIN Standards
- High Visibility Size Markings
- Supplied in industry approved EVA foam



Part No.	Description
XF204	4mm
XF205	5mm
XF206	6mm
XF207	7mm
XF208	8mm
XF209	9mm
XF210	10mm
XF211	11mm
XF212	12mm
XF213	13mm



**Franklin XF 13 pce Multi-Drive Socket Set 1/4" dr**  
**XFM13**

4 4.5 5 5.5 6 7 8 9 10 11 12 13 14mm x 24mm

**Features**

- High Grade Chrome Vanadium Steel
- XF Multi-Drive - Fits most fastener profiles
- Mirror finish with Anti-Slip Knurl
- Manufactured to DIN Standards
- High Visibility Size Markings
- Supplied in industry approved EVA foam



Part No.	Description
XFM104	4mm
XFM145	4.5mm
XFM105	5mm
XFM155	5.5mm
XFM106	6mm
XFM107	7mm
XFM108	8mm
XFM109	9mm
XFM110	10mm
XFM111	11mm
XFM112	12mm
XFM113	13mm
XFM114	14mm

**Franklin 13 pce Low Profile Multidrive Socket Set 1/4" dr**  
**XFLM13**

4 4.5 5 5.5 6 7 8 9 10 11 12 13 14mm x 17mm

**Features**

- High Grade Chrome Vanadium Steel
- XF Multi-Drive - Fits most fastener profiles
- Mirror finish with Anti-Slip Knurl
- Manufactured to DIN Standards
- High Visibility Size Markings
- Supplied in industry approved EVA foam



**Franklin XF 27 pce Bit Socket Set 1/4" dr**  
**XF027**

- Flat : 4 5.5 7mm x 37mm
- Hex : H3 H4 H5 H6 H7 H8 x 37mm
- Star : T10 T15 T20 T25 T27 T30 T40 x 37mm
- Spline : M4 M5 M6 M8 M10 x 37mm
- PH1 PH2 PH3 - PZ1 PZ2 PZ3 x 37mm

**Features**

- High Grade Chrome Vanadium Steel Sockets
- S2 Steel Bits
- Mirror finish with Anti-Slip Knurl
- High Visibility Size Markings
- Supplied in industry approved EVA foam



Part No.	Description
14H03	3mm
14H04	4mm
14H05	5mm
14H06	6mm
14H07	7mm
14H08	8mm
14PH1	PH1
14PH2	PH2
14PH3	PH3
14PZ1	PZ1
14PZ2	PZ2
14PZ3	PZ3
14SL4	SL4
14SL55	SL5.5
14SL7	SL7
14X04	M4
14X05	M5
14X06	M6
14X08	M8
14X10	M10
TS110	T10
TS115	T15
TS120	T20
TS125	T25
TS127	T27
TS130	T30
TS140	T40





**Franklin 16pce 95mm Long Star Bit Set 1/4" dr**  
**XF016**

- Star : T9 T10 T15 T20 T25 T27 T30 T40 x 95mm
- Tamperproof Star : TP9 TP10 TP15 TP20 TP25 TP27 TP30 TP40 x 95mm

- Features**
- High Grade Chrome Vanadium Steel Sockets
  - S2 Steel Bits
  - Mirror finish with Anti-Slip Knurl
  - High Visibility Size Markings
  - Supplied in industry approved EVA foam



Part No.	Description
TS209	T9
TS210	T10
TS215	T15
TS220	T20
TS225	T25
TS227	T27
TS230	T30
TS240	T40
24TP09	TP9
24TP10	TP10
24TP15	TP15
24TP20	TP20
24TP25	TP25
24TP27	TP27
24TP30	TP30
24TP40	TP40



**Franklin 7 pce Star Plus Bit Set 1/4" dr**  
**XFTSP7**

T10 T15 T20 T25 T27 T30 T40 5 Point Tamperproof Bits

- Features**
- High Grade Chrome Vanadium Steel Sockets
  - S2 Steel Bits
  - Supplied in Industry Approved EVA Foam



**Franklin 20pce 95mm Long Bit Set 1/4" dr**  
**XF020**

- Flat : 4 5.5 7mm x 95mm
- Hex : H3 H4 H5 H6 H7 H8 x 95mm
- Spline : M4 M5 M6 M8 M10 x 95mm
- PH1 PH2 PH3 - PZ1 PZ2 PZ3 x 95mm

- Features**
- High Grade Chrome Vanadium Steel Sockets
  - S2 Steel Bits
  - Mirror finish with Anti-Slip Knurl
  - High Visibility Size Markings
  - Supplied in industry approved EVA foam



Part No.	Description
24H03	3mm
24H04	4mm
24H05	5mm
24H06	6mm
24H07	7mm
24H08	8mm
24PH1	PH1
24PH2	PH2
24PH3	PH3
24PZ1	PZ1
24PZ2	PZ2
24PZ3	PZ3
24SL4	SL4
24SL55	SL5.5
24SL7	SL7
24X04	M4
24X05	M5
24X06	M6
24X08	M8
24X10	M10



**Franklin XF 12 pce Low Profile External Star Set 3/8" dr**  
**XFPE12**

E4 E5 E6 E7 E8 E10 E11 E12 E14 E16 E18 E20 x 22mm

- Features**
- High Grade Chrome Vanadium Steel
  - Mirror finish
  - Manufactured to DIN Standards
  - High Visibility Size Markings
  - Supplied in industry approved EVA foam



Part No.	Description
SEP04	E4
SEP05	E5
SEP06	E6
SEP07	E7
SEP08	E8
SEP10	E10
SEP11	E11
SEP12	E12
SEP14	E14
SEP16	E16
SEP18	E18
SEP20	E20





**Franklin XF 14 pce External Star Socket Set 1/4" 3/8" 1/2" dr XFE14**

- 1/4" dr - E4 E5 E6 E7 E8 x 24mm
- 3/8" dr - E10 E11 E12 E14 x 27mm
- 1/2" dr - E16 E18 E20 E22 E24 x 38mm

**Features**

- High Grade Chrome Vanadium Steel
- Mirror finish with Anti-Slip Knurl
- Manufactured to DIN Standards
- High Visibility Size Markings
- Supplied in industry approved EVA foam



Part No.	Description
SE104	1/4" x E4
SE105	1/4" x E5
SE106	1/4" x E6
SE107	1/4" x E7
SE108	1/4" x E8
SE110	3/8" x E10
SE111	3/8" x E11
SE112	3/8" x E12
SE114	3/8" x E14
SE116	3/8" x E16 Additional Size
SE216	1/2" x E16
SE218	1/2" x E18
SE220	1/2" x E20
SE222	1/2" x E22
SE224	1/2" x E24



**Franklin XF 12 pce 12 pt Low Profile Socket Set 3/8" dr XFL12**

8 9 10 11 12 13 14 15 16 17 18 19 mm x 20mm

**Features**

- High Grade Chrome Vanadium Steel
- Mirror finish
- High Visibility Size Markings
- Supplied in industry approved EVA foam



Part No.	Description
XF3L08	8mm
XF3L09	9mm
XF3L10	10mm
XF3L11	11mm
XF3L12	12mm
XF3L13	13mm
XF3L14	14mm
XF3L15	15mm
XF3L16	16mm
XF3L17	17mm
XF3L18	18mm
XF3L19	19mm



**Franklin XF 14 pce External Star Deep Socket Set 1/4" 3/8" 1/2" dr XFEL14**

- 1/4" dr - E4 E5 E6 E7 E8 x 50mm
- 3/8" dr - E10 E11 E12 E14 x 63mm
- 1/2" dr - E16 E18 E20 E22 E24 x 77mm

**Features**

- High Grade Chrome Vanadium Steel
- Mirror finish with Anti-Slip Knurl
- Manufactured to DIN Standards
- High Visibility Size Markings
- Supplied in industry approved EVA foam



**Franklin XF 18 pce 6 pt Socket Set 3/8" dr XF3018**

6 7 8 9 10 11 12 13 14 15 16 17 18 19 20 21 22 24mm x 30mm

**Features**

- High Grade Chrome Vanadium Steel
- Mirror finish with Anti-Slip Knurl
- XF flank drive - 30% more torque
- Manufactured to DIN Standards
- High Visibility Size Markings
- Supplied in industry approved EVA foam



Part No.	Description
XF306	6mm
XF307	7mm
XF308	8mm
XF309	9mm
XF310	10mm
XF311	11mm
XF312	12mm
XF313	13mm
XF314	14mm
XF315	15mm
XF316	16mm
XF317	17mm
XF318	18mm
XF319	19mm
XF320	20mm
XF321	21mm
XF322	22mm
XF324	24mm





**Franklin XF 12 pce 6 pt Deep Socket Set 3/8" dr**  
**XF4012**

8 9 10 11 12 13 14 15 16 17 18 19mm x 63mm

**Features**

- High Grade Chrome Vanadium Steel
- Mirror finish with Anti-Slip Knurl
- XF flank drive – 30% more torque
- Manufactured to DIN Standards
- High Visibility Size Markings
- Supplied in industry approved EVA foam



Part No.	Description
XF406	6mm Additional Size
XF407	7mm Additional Size
XF408	8mm
XF409	9mm
XF410	10mm
XF411	11mm
XF412	12mm
XF413	13mm
XF414	14mm
XF415	15mm
XF416	16mm
XF417	17mm
XF418	18mm
XF419	19mm



**Franklin XF 18 pce 12 pt Socket Set 3/8" dr**  
**XF5018**

6 7 8 9 10 11 12 13 14 15 16 17 18 19 20 21 22 24mm x 30mm

**Features**

- High Grade Chrome Vanadium Steel
- Mirror finish with Anti-Slip Knurl
- XF flank drive – 30% more torque
- Manufactured to DIN Standards
- High Visibility Size Markings
- Supplied in industry approved EVA foam



Part No.	Description
XF506	6mm
XF507	7mm
XF508	8mm
XF509	9mm
XF510	10mm
XF511	11mm
XF512	12mm
XF513	13mm
XF514	14mm
XF515	15mm
XF516	16mm
XF517	17mm
XF518	18mm
XF519	19mm
XF520	20mm
XF521	21mm
XF522	22mm
XF524	24mm



**Franklin XF 19 pce 6 pt Deep Socket Set 3/8" dr**  
**XF4019**

6 7 8 9 10 11 12 13 14 15 16 17 18 19 20 21 22 23 24mm x 63mm

**Features**

- High Grade Chrome Vanadium Steel
- XF flank drive – 30% more torque
- Mirror Finish with Anti-Slip Knurl
- Manufactured to DIN Standards
- High Visibility Size Markings (for easy identification)
- Supplied in Industry Approved EVA Foam



Part No.	Description
XF406	6mm
XF407	7mm
XF408	8mm
XF409	9mm
XF410	10mm
XF411	11mm
XF412	12mm
XF413	13mm
XF414	14mm
XF415	15mm
XF416	16mm
XF417	17mm
XF418	18mm
XF419	19mm
XF420	20mm
XF421	21mm
XF422	22mm
XF423	23mm
XF424	24mm



**Franklin XF 19 pce 12 pt Deep Socket Set 3/8" dr**  
**XF5019**

6 7 8 9 10 11 12 13 14 15 16 17 18 19 20 21 22 23 24mm x 63mm

**Features**

- High Grade Chrome Vanadium Steel
- XF flank drive – 30% more torque
- Mirror Finish with Anti-Slip Knurl
- Manufactured to DIN Standards
- High Visibility Size Markings (for easy identification)
- Supplied in Industry Approved EVA Foam



Part No.	Description
XF5506	6mm
XF5507	7mm
XF5508	8mm
XF5509	9mm
XF5510	10mm
XF5511	11mm
XF5512	12mm
XF5513	13mm
XF5514	14mm
XF5515	15mm
XF5516	16mm
XF5517	17mm
XF5518	18mm
XF5519	19mm
XF5520	20mm
XF5521	21mm
XF5522	22mm
XF5523	23mm
XF5524	24mm





**Franklin XF 19 pce Multi-Drive Socket Set 3/8" dr**  
**XFM19**

6 7 8 9 10 11 12 13 14 15 16 17 18 19 20 21 22 23 24mm x 30mm

**Features**

- High Grade Chrome Vanadium Steel
- XF Multi-Drive - Fits most fastener profiles
- Mirror finish with Anti-Slip Knurl
- Manufactured to DIN Standards
- High Visibility Size Markings
- Supplied in industry approved EVA foam



3/8"



Part No.	Description
XFM306	6mm
XFM307	7mm
XFM308	8mm
XFM309	9mm
XFM310	10mm
XFM311	11mm
XFM312	12mm
XFM313	13mm
XFM314	14mm
XFM315	15mm
XFM316	16mm
XFM317	17mm
XFM318	18mm
XFM319	19mm
XFM320	20mm
XFM321	21mm
XFM322	22mm
XFM323	23mm
XFM324	24mm



**Franklin XF 9 pce Hexagon Bit Socket Set 3/8" dr**  
**XFH09**

4 5 6 7 8 9 10 11 12 x 48 mm

**Features**

- High Grade Chrome Vanadium Steel Sockets
- S2 Steel Bits
- Mirror finish with Anti-Slip Knurl
- Manufactured to DIN Standards
- High Visibility Size Markings
- Supplied in industry approved EVA foam



3/8"



Part No.	Description
2304	4mm
2305	5mm
2306	6mm
2307	7mm
2308	8mm
2309	9mm
2310	10mm
2311	11mm
2312	12mm
2313	13mm Additional Size
2314	14mm Additional Size



**Franklin XF 9 pce Low Profile Hexagon Socket Set 3/8" dr**  
**XFLH9**

4 5 6 7 8 9 10 11 12 x 27mm

**Features**

- Low Profile Sockets for working in confined spaces
- High Grade Chrome Vanadium Steel Sockets
- S2 Steel Bits
- Mirror finish with Anti-Slip Knurl
- High Visibility Size Markings
- Supplied in industry approved EVA foam



3/8"



Part No.	Description
1304	4mm
1305	5mm
1306	6mm
1307	7mm
1308	8mm
1309	9mm
1310	10mm
1311	11mm
1312	12mm



**Franklin XF 9 pce Long Hexagon Bit Socket Set 3/8" dr**  
**XFHL9**

4 5 6 7 8 9 10 11 12 x 95 mm

**Features**

- High Grade Chrome Vanadium Steel Sockets
- S2 Steel Bits
- Mirror finish with Anti-Slip Knurl
- Manufactured to DIN Standards
- High Visibility Size Markings
- Supplied in industry approved EVA foam



3/8"



Part No.	Description
2504	4mm
2505	5mm
2506	6mm
2507	7mm
2508	8mm
2509	9mm
2510	10mm
2511	11mm
2512	12mm



**Franklin XF 9 pce 200mm Long Hexagon Bit Socket Set 3/8" dr XFYH9**

4mm 5mm 6mm 7mm 8mm 9mm 10mm 11mm 12mm X 200mm

**Features**

- High Grade Chrome Vanadium Steel Sockets
- S2 Steel Bits
- Mirror finish with Anti-Slip Knurl
- Manufactured to DIN Standards
- High Visibility Size Markings
- Supplied in industry approved EVA foam



3/8"



Part No.	Description
2604	4mm
2605	5mm
2606	6mm
2607	7mm
2608	8mm
2609	9mm
2610	10mm
2611	11mm
2612	12mm



**Franklin XF 9 pce 200mm Hexagon Long Ball End Bit Socket Set 3/8" dr XFYBH9**

4mm 5mm 6mm 7mm 8mm 9mm 10mm 11mm 12mm x 200mm

**Features**

- High Grade Chrome Vanadium Steel Sockets
- S2 Steel Bits
- Mirror finish with Anti-Slip Knurl
- Manufactured to DIN Standards
- High Visibility Size Markings
- Supplied in industry approved EVA foam



3/8"



Part No.	Description
4904	4mm
4905	5mm
4906	6mm
4907	7mm
4908	8mm
4909	9mm
4910	10mm
4911	11mm
4912	12mm



**Franklin XF 9 pce Hexagon Long Ball End Bit Socket Set 3/8" dr XFBH9**

4 5 6 7 8 9 10 11 12 x 95 mm

**Features**

- High Grade Chrome Vanadium Steel Sockets
- S2 Steel Bits
- Mirror finish with Anti-Slip Knurl
- Manufactured to DIN Standards
- High Visibility Size Markings
- Supplied in industry approved EVA foam



3/8"



Part No.	Description
4804	4mm
4805	5mm
4806	6mm
4807	7mm
4808	8mm
4809	9mm
4810	10mm
4811	11mm
4812	12mm



**Franklin XF 10 pce Low Profile Star Socket Set 3/8" dr XFLS10**

T10 T15 T20 T25 T27 T30 T40 T45 T50 T55 x 27mm

**Features**

- For use on Torx type fasteners
- Low Profile Sockets for working in confined spaces
- High Grade Chrome Vanadium Steel sockets
- S2 Steel Bits
- Mirror Finish with Anti-Slip Knurl
- High Visibility Size Markings
- Supplied in industry approved EVA foam



3/8"



Part No.	Description
TS010	T10
TS015	T15
TS020	T20
TS025	T25
TS027	T27
TS030	T30
TS040	T40
TS045	T45
TS050	T50
TS055	T55





**Franklin XF 10 pce Star Bit Socket Set 3/8" dr**  
**XFS10**

T10 T15 T20 T25 T27 T30 T40 T45 T50 T55 x 48 mm

**Features**

- For use on Torx type fasteners
- High Grade Chrome Vanadium Steel Sockets
- S2 Steel Bits
- Mirror finish with Anti-Slip Knurl
- Manufactured to DIN Standards
- High Visibility Size Markings
- Supplied in industry approved EVA foam



Part No.	Description
TS10	T10
TS15	T15
TS20	T20
TS25	T25
TS27	T27
TS30	T30
TS40	T40
TS45	T45
TS47	T47 Additional Size
TS50	T50
TS55	T55

3/8"



**Franklin XF 8 pce 200mm Long Star Bit Socket Set 3/8" dr**  
**XFYS8**

T20 T25 T27 T30 T40 T45 T50 T55 x 200mm

**Features**

- For use on Torx type fasteners
- High Grade Chrome Vanadium Steel Sockets
- S2 Steel Bits
- Mirror finish with Anti-Slip Knurl
- Manufactured to DIN Standards
- High Visibility Size Markings
- Supplied in industry approved EVA foam



3/8"



Part No.	Description
TS20Y	T20
TS25Y	T25
TS27Y	T27
TS30Y	T30
TS40Y	T40
TS45Y	T45
TS50Y	T50
TS55Y	T55

**Franklin XF 7 pce Long Star Bit Socket Set 3/8" dr**  
**XFSL7**

T20 T25 T30 T40 T45 T50 T55 x 95 mm

**Features**

- For use on Torx type fasteners
- High Grade Chrome Vanadium Steel Sockets
- S2 Steel Bits
- Mirror finish with Anti-Slip Knurl
- Manufactured to DIN Standards
- High Visibility Size Markings
- Supplied in industry approved EVA foam



3/8"



Part No.	Description
TS20L	T20
TS25L	T25
TS30L	T30
TS40L	T40
TS45L	T45
TS50L	T50
TS55LL	T55

**Franklin 9 pce Star Plus Bit Socket Set 3/8" dr**  
**XFSP9**

TPS 20 25 27 30 40 45 50 55 60 - Star Plus. For use with Torx Plus fasteners (as used by car assembly plants) for improved torque transfer and better product performance

**Features**

- High Grade Chrome Vanadium Steel Sockets
- S2 Steel Bits
- Satin Finish
- Roll Marked Size For Easy Identification
- Supplied in Industry Approved EVA Foam

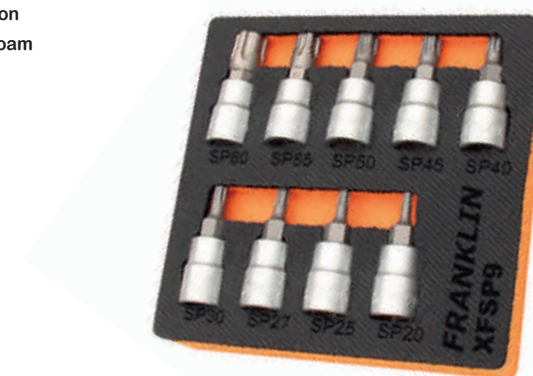

3/8"



**Franklin XF 8 pce Low Profile Tamper Star Socket Set 3/8" dr XFLTS8**

T20 T25 T27 T30 T40 T45 T50 T55 x 27mm

**Features**

- Low Profile Sockets for working in confined spaces
- High Grade Chrome Vanadium Steel Sockets
- S2 Steel Bits
- Mirror finish with Anti-Slip Knurl
- High Visibility Size Markings
- Supplied in industry approved EVA foam



3/8"



Part No.	Description
TSTL20	T20
TSTL25	T25
TSTL27	T27
TSTL30	T30
TSTL40	T40
TSTL45	T45
TSTL50	T50
TSTL55	T55



**Franklin XF 8 pce Long Tamper Star Bit Socket Set 3/8" dr XFTSL8**

T20 T25 T27 T30 T40 T45 T50 T55 x 95 mm

**Features**

- High Grade Chrome Vanadium Steel Sockets
- S2 Steel Bits
- Mirror finish with Anti-Slip Knurl
- Manufactured to DIN Standards
- High Visibility Size Markings
- Supplied in industry approved EVA foam



3/8"



Part No.	Description
TST20L	T20
TST25L	T25
TST27L	T27
TST30L	T30
TST40L	T40
TST45L	T45
TST50L	T50
TST55L	T55



**Franklin XF 8 pce Tamper Star Bit Socket Set 3/8" dr XFTS8**

T20 T25 T27 T30 T40 T45 T50 T55 x 48 mm

**Features**

- High Grade Chrome Vanadium Steel Sockets
- S2 Steel Bits
- Mirror finish with Anti-Slip Knurl
- Manufactured to DIN Standards
- High Visibility Size Markings
- Supplied in industry approved EVA foam



3/8"



Part No.	Description
TST20	T20
TST25	T25
TST27	T27
TST30	T30
TST40	T40
TST45	T45
TST50	T50
TST55	T55



**Franklin XF 10 pce Low Profile Ribe Set 3/8" dr XFLR10**

M4 M5 M6 M7 M8 M9 M10 M12 M13 M14 x 27 mm

**Features**

- Low Profile Sockets for working in confined spaces
- High Grade Chrome Vanadium Steel sockets
- S2 Steel Bits
- Mirror finish with Anti-Slip Knurl
- High Visibility Size Markings
- Supplied in industry approved EVA foam



3/8"



Part No.	Description
710004	M4
710005	M5
710006	M6
710007	M7
710008	M8
710009	M9
710010	M10
710012	M12
710013	M13
710014	M14





**Franklin XF 10 pce Ribe Bit Socket Set 3/8" 1/2" dr**  
**XFRS10**

- M4 M5 M6 M7 M8 M9 M10 x 47mm - 3/8" dr
- M12 M13 M14 x 55 mm - 1/2" dr

**Features**

- High Grade Chrome Vanadium Steel Sockets
- S2 Steel Bits
- Mirror finish with Anti-Slip Knurl
- Manufactured to DIN Standards
- High Visibility Size Markings
- Supplied in industry approved EVA foam



Part No.	Description
710104	M4 x 3/8" dr
710105	M5 x 3/8" dr
710106	M6 x 3/8" dr
710107	M7 x 3/8" dr
710108	M8 x 3/8" dr
710109	M9 x 3/8" dr
710110	M10 x 3/8" dr
710112	M12 x 1/2" dr
710113	M13 x 1/2" dr
710114	M14 x 1/2" dr



**Franklin XF 7 pce Low Profile Spline Set 3/8" dr**  
**XFLX7**

- M4 M5 M6 M8 M10 M12 M14 X 27mm

**Features**

- Low Profile Sockets for working in confined spaces
- High Grade Chrome Vanadium Steel Sockets
- S2 Steel Bits
- Mirror finish with Anti-Slip Knurl
- High Visibility Size Markings
- Supplied in industry approved EVA foam



Part No.	Description
562004	M4
562005	M5
562006	M6
562008	M8
562010	M10
562012	M12
562014	M14



**Franklin XF 8 pce Long Ribe Bit Socket Set 3/8" 1/2" dr**  
**XFRL8**

- M6 M7 M8 M9 M10 x 95mm - 3/8" dr
- M12 M13 M14 x 100mm - 1/2" dr

**Features**

- High Grade Chrome Vanadium Steel Sockets
- S2 Steel Bits
- Mirror finish with Anti-Slip Knurl
- Manufactured to DIN Standards
- High Visibility Size Markings
- Supplied in industry approved EVA foam



Part No.	Description
5806	M6 x 3/8" dr
5807	M7 x 3/8" dr
5808	M8 x 3/8" dr
5809	M9 x 3/8" dr
5810	M10 x 3/8" dr
5812	M12 x 1/2" dr
5813	M13 x 1/2" dr
5814	M14 x 1/2" dr



**Franklin XF 7 pce Long Spline Bit Socket Set 3/8" dr**  
**XFXL7**

- M4 M5 M6 M8 M10 M12 M14 x 95 mm

**Features**

- High Grade Chrome Vanadium Steel Sockets
- S2 Steel Bits
- Mirror finish with Anti-Slip Knurl
- Manufactured to DIN Standards
- High Visibility Size Markings
- Supplied in industry approved EVA foam



Part No.	Description
562204	M4
562205	M5
562206	M6
562208	M8
562210	M10
562212	M12
562214	M14



**Franklin XF 7 pce Spline Bit Socket Set 3/8" dr**  
**XFXS7**

M4 M5 M6 M8 M10 M12 M14 x 47 mm

**Features**

- High Grade Chrome Vanadium Steel Sockets
- S2 Steel Bits
- Mirror finish with Anti-Slip Knurl
- Manufactured to DIN Standards
- High Visibility Size Markings
- Supplied in industry approved EVA foam



3/8"



Part No.	Description
562104	M4
562105	M5
562106	M6
562108	M8
562110	M10
562112	M12
562114	M14



**Franklin XF 18 pce Drain Plug Key Set 3/8" dr**  
**XFDP18**

- Hexagon - 8mm, 9mm, 10mm, 12mm, 14mm, 17mm x 36mm
- Square Male - 7mm, 8mm, 10mm, 11mm, 12mm, 13mm, 14mm, 5/16", 3/8" x 36mm
- Square Female - 10mm x 36mm • Triangle - 10mm x 36mm • Star - T45 x 36mm

**Features**

- Suitable for sump plugs on engine, gearbox and back axle
- Chrome Vanadium Steel & Satin Finish
- Clear Roll Marked Size for Easy Identification
- Supplied in industry approved EVA foam



3/8"



Part No.	Description
18H8	8mm Hex
18H9	9mm Hex
18H10	10mm Hex
18H12	12mm Hex
18H14	14mm Hex
18H17	17mm Hex
18S7	7mm Square
18S8	8mm Square
18S10	10mm Square
18S11	11mm Square
18S12	12mm Square
18S13	13mm Square
18S14	14mm Square
18S516	5/16" Square
18S38	3/8" Square
18T45	T45 Star
18XS10	10mm Female Square
18XT10	10mm Triangle

**Franklin XF 9 pce Screwdriver Bit Socket Set 3/8" dr**  
**XFSD9**

- PH1, PH2, PH3 x 48mm
- PZ1, PZ2, PZ3 x 48mm
- SL5.5, SL6.5, SL8 x 48mm

**Features**

- High Grade Chrome Vanadium Steel
- S2 Steel Bits
- Mirror finish with Anti-Slip Knurl
- Manufactured to DIN Standards
- High Visibility Size Markings
- Supplied in industry approved EVA foam



3/8"



Part No.	Description
38PH1	PH1
38PH2	PH2
38PH3	PH3
38PZ1	PZ1
38PZ2	PZ2
38PZ3	PZ3
38SL55	SL5.5
38SL65	SL6.5
38SL8	SL8



**Franklin XF 7 pce 6 pt Low Profile Filter Socket Set 3/8" dr**  
**XFLO7**

24 27 29 30 32 36 38mm x 30mm

**Features**

- High Grade Chrome Vanadium Steel
- Mirror finish
- High Visibility Size Markings
- Supplied in industry approved EVA foam



3/8"



Part No.	Description
XFLO24	24mm
XFLO27	27mm
XFLO29	29mm
XFLO30	30mm
XFLO32	32mm
XFLO36	36mm
XFLO38	38mm



**Franklin XF 17 pce 6 pt Socket Set 1/2" dr**  
**XF6017**

10 11 12 13 14 15 16 17 18 19 20 21 22 24 27 30 32mm x 38mm

**Features**

- High Grade Chrome Vanadium Steel
- XF flank drive – 30% more torque
- Manufactured to DIN Standards
- Mirror finish with Anti-Slip Knurl
- High Visibility Size Markings
- Supplied in industry approved EVA foam



Part No.	Description
XF610	10mm
XF611	11mm
XF612	12mm
XF613	13mm
XF614	14mm
XF615	15mm
XF616	16mm
XF617	17mm
XF618	18mm
XF619	19mm
XF620	20mm
XF621	21mm
XF622	22mm
XF624	24mm
XF627	27mm
XF630	30mm
XF632	32mm



**Franklin XF 23 pce 12 pt Socket Set 1/2" dr**  
**XF8023**

8 9 10 11 12 13 14 15 16 17 18 19 20 21 22 23 24 25 26 27 28 30 32mm x 38mm

**Features**

- High Grade Chrome Vanadium Steel
- Mirror finish with Anti-Slip Knurl
- XF flank drive – 30% more torque
- Manufactured to DIN Standards
- High Visibility Size Markings
- Supplied in industry approved EVA foam



Part No.	Description
XF808	8mm
XF809	9mm
XF810	10mm
XF811	11mm
XF812	12mm
XF813	13mm
XF814	14mm
XF815	15mm
XF816	16mm
XF817	17mm
XF818	18mm
XF819	19mm
XF820	20mm
XF821	21mm
XF822	22mm
XF823	23mm
XF824	24mm
XF825	25mm
XF826	26mm
XF827	27mm
XF828	28mm
XF830	30mm
XF832	32mm



**Franklin XF 13 pce 6 pt Deep Socket Set 1/2" dr**  
**XF7013**

10 11 12 13 14 15 16 17 18 19 21 22 24mm x 77mm

**Features**

- High Grade Chrome Vanadium Steel
- XF flank drive – 30% more torque
- Manufactured to DIN Standards
- Mirror finish with Anti-Slip Knurl
- High Visibility Size Markings
- Supplied in industry approved EVA foam



Part No.	Description
XF710	10mm
XF711	11mm
XF712	12mm
XF713	13mm
XF714	14mm
XF715	15mm
XF716	16mm
XF717	17mm
XF718	18mm
XF719	19mm
XF721	21mm
XF722	22mm
XF724	24mm



**Franklin XF 23 pce Multi-Drive Socket Set 1/2" dr**  
**XF823**

8 9 10 11 12 13 14 15 16 17 18 19 20 21 22 23 24 25 26 27 28 30 32mm x 38mm

**Features**

- High Grade Chrome Vanadium Steel
- XF Multi-Drive - Fits most fastener profiles
- Mirror finish with Anti-Slip Knurl
- Manufactured to DIN Standards
- High Visibility Size Markings
- Supplied in industry approved EVA foam



Part No.	Description
XF8208	8mm
XF8209	9mm
XF8210	10mm
XF8211	11mm
XF8212	12mm
XF8213	13mm
XF8214	14mm
XF8215	15mm
XF8216	16mm
XF8217	17mm
XF8218	18mm
XF8219	19mm
XF8220	20mm
XF8221	21mm
XF8222	22mm
XF8223	23mm
XF8224	24mm
XF8225	25mm
XF8226	26mm
XF8227	27mm
XF8228	28mm
XF8232	32mm



**Franklin XF 9 pce External Star Socket Set 1/2" dr**  
**XFE200**

E10 E11 E12 E14 E16 E18 E20 E22 E24 x 38mm

**Features**

- High Grade Chrome Vanadium Steel
- Mirror finish with Anti-Slip Knurl
- Manufactured to DIN Standards
- High Visibility Size Markings
- Supplied in industry approved EVA foam



1/2"



Part No.	Description
SE210	E10
SE211	E11
SE212	E12
SE214	E14
SE216	E16
SE218	E18
SE220	E20
SE222	E22
SE224	E24



**Franklin XF 8 pce Long Hexagon Bit Socket Set 1/2" dr**  
**XFHL8**

6 7 8 10 12 13 14 17 x 100 mm

**Features**

- High Grade Chrome Vanadium Steel Sockets
- S2 Steel Bits
- Mirror finish with Anti-Slip Knurl
- Manufactured to DIN Standards
- High Visibility Size Markings
- Supplied in industry approved EVA foam



1/2"



Part No.	Description
5306	6mm
5307	7mm
5308	8mm
5310	10mm
5312	12mm
5313	13mm
5314	14mm
5317	17mm



**Franklin XF 11 pce Hexagon Bit Socket Set 1/2" dr**  
**XFH11**

6 7 8 9 10 11 12 13 14 17 19 x 55 mm

**Features**

- High Grade Chrome Vanadium Steel Sockets
- S2 Steel Bits
- Mirror finish with Anti-Slip Knurl
- Manufactured to DIN Standards
- High Visibility Size Markings
- Supplied in industry approved EVA foam



1/2"



Part No.	Description
4306	6mm
4307	7mm
4308	8mm
4309	9mm
4310	10mm
4311	11mm
4312	12mm
4313	13mm
4314	14mm
4316	16mm Additional Size
4317	17mm
4319	19mm



**Franklin XF 6 pce Long Star Bit Socket Set 1/2" dr**  
**XFSL6**

T55 T60 T70 T80 T90 T100 x 100 mm

**Features**

- For use on Torx type fasteners
- High Grade Chrome Vanadium Steel Sockets
- S2 Steel Bits
- Mirror finish with Anti-Slip Knurl
- Manufactured to DIN Standards
- High Visibility Size Markings
- Supplied in industry approved EVA foam



1/2"



Part No.	Description
TSL55	T55
TSL60	T60
TSL70	T70
TSL80	T80
TSL90	T90
TSL100	T100





**Franklin XF 6 pce Long Spline Bit Socket Set 1/2" dr**  
**XFXL6**

M6 M8 M9 M10 M12 M14 x 100 mm

**Features**

- High Grade Chrome Vanadium Steel Sockets
- S2 Steel Bits
- Mirror finish with Anti-Slip Knurl
- Manufactured to DIN Standards
- High Visibility Size Markings
- Supplied in industry approved EVA foam

Part No.	Description
5406	M6
5408	M8
5409	M9
5410	M10
5412	M12
5414	M14



1/2"



**Franklin XF 3 pce 6 pt Alloy Wheel Nut Socket Set 1/2" dr**  
**XFAS3**

17 19 21 x 85 mm

**Features**

- Chrome Molybdenum Steel
- Deep Thin Wall Impact Sockets
- Sleeved to avoid damage to alloys
- Colour coded anodised finish
- Supplied in industry approved EVA foam



1/2"



**Franklin 4 pce Spline Bit Socket Set 300mm 1/2" dr**  
**XFXL4**

M8 M10 M12 M14 x 300mm

Extra Long for use where Fasteners Cannot be Reached with Standard Length Bits

**Features**

- High Grade Chrome Vanadium Steel Sockets
- S2 Steel Bits
- Satin Finish
- Roll Marked Size For Easy Identification
- Supplied in Industry Approved EVA Foam



1/2"

400 SERIES



**Franklin XF 4 pce Alloy Wheel Nut Socket Set 1/2" dr**  
**XFAS4**

17 (Mercedes), 21 (Kia), 23, 27 x 85 mm

**Features**

- Chrome Molybdenum Steel
- Deep Thin Wall Impact Sockets
- Sleeved to avoid damage to alloys
- Supplied in industry approved EVA foam

Part No.	Description
FASKIA	Kia
FASMER	Mercedes
FAS23	23mm
FAS27	27mm



1/2"



**Franklin XF 6 pce 6 pt Alloy Wheel Nut Socket Set 1/2" dr**  
**XFAS6**

15 17 19 21 22 24 x 85 mm

**Features**

- Chrome Molybdenum Steel
- Deep Thin Wall Impact Sockets
- Sleeved to avoid damage to alloys
- Colour coded anodised finish
- Supplied in industry approved EVA foam

Part No.	Description
FAS15	15mm
FAS17	17mm
FAS19	19mm
FAS21	21mm
FAS22	22mm
FAS24	24mm



**Franklin XF 10 pce Impact Bolt Extractor Set 3/8" dr**  
**AFB01**

10 11 12 13 14 15 16 17 18 19 x 31mm

**Features**

- High Grade Chrome Molybdenum Steel
- Black Phosphate Finish Fluted Design
- Laser etched size markings (for easy identification)
- Grips/Removes Damaged Nuts Bolts & Screws
- Supplied with 80mm Drift to Remove Nuts from the Socket
- Supplied in industry approved EVA foam

Part No.	Description
AFB10	10mm
AFB11	11mm
AFB12	12mm
AFB13	13mm
AFB14	14mm
AFB15	15mm
AFB16	16mm
AFB17	17mm
AFB18	18mm
AFB19	19mm



**Franklin XF 10 pce Bolt Extractor Set 3/8" dr**  
**XFB010**

8 10 12 13 14 15 16 17 18 19 mm

**Features**

- High Grade Chrome Molybdenum Steel
- For removing damaged, rusted, painted, rounded-off bolts and nuts etc
- Reverse spiral flutes for improved grip
- Lobular design for extended coverage
- Supplied in Industry Approved EVA Foam

Part No.	Description
XFB08	8mm
XFB10	10mm
XFB12	12mm
XFB13	13mm
XFB14	14mm
XFB15	15mm
XFB16	16mm
XFB17	17mm
XFB18	18mm
XFB19	19mm



**Franklin 6 pce Impact Bolt Extractor Set 1/2" dr**  
**AFBW6**

17 19 21 22 24 27 mm x 34mm

**Features**

- High Grade Chrome Molybdenum Steel
- Black Phosphate Finish Fluted Design
- Laser etched size markings (for easy identification)
- Grips/Removes Damaged Nuts Bolts & Screws
- Supplied in industry approved EVA foam

Part No.	Description
AFBW17	17mm
AFBW19	19mm
AFBW21	21mm
AFBW22	22mm
AFBW24	24mm
AFBW27	27mm





**Franklin 3 pce 150mm Lock Nut Removal Tool Set 1/2" dr**  
**AFBW3**

17 19 21mm x 150mm

**Features**

- High Grade Chrome Molybdenum Steel
  - Black Phosphate Finish Fluted Design
  - Laser etched size markings (for easy identification)
  - Grips/Removes Damaged Nuts Bolts and Screws
  - Supplied in industry approved EVA foam
- Test for hardness with centre punch, only use if indentation is made
- N.B This is not normally suitable for use on security wheel nuts with rotating outer sleeves

Part No.	Description
AFBW31	17mm
AFBW32	19mm
AFBW33	21mm



1/2"



**Franklin XF 6 pce Impact Adaptor Set**  
**XFI200**

- 1/4" F x 3/8" M
- 3/8" F x 1/4" M
- 3/8" F x 1/2" M
- 1/2" F x 3/8" M
- 1/2" F x 3/4" M
- 3/4" F x 1/2" M

**Features**

- Chrome Molybdenum Steel
- Black Phosphate Finish
- Laser etched size markings (for easy identification)
- Supplied in industry approved EVA foam

Part No.	Description
FT2001	1/4" F x 3/8" M
FT2002	3/8" F x 1/4" M
FT201	3/4" F x 1/2" M
FT202	1/2" F x 3/8" M
FT203	1/2" F x 3/4" M
FT204	3/8" F x 1/2" M
FT205	3/4" F x 1" M Additional Size
FT206	1" F x 3/4" M Additional Size



**Franklin 7 pce Lock Nut Removal Tool Set 1/2" dr**  
**AFBW7**

17 18.5 20 21.5 23 24.5 26 mm - 1/2" dr, Left Hand Threaded Sockets

**Features**

- For removing security wheel nuts (when the key has been lost), damaged wheel nuts and other threaded studs/fasteners
  - Internal left hand reverse threads
  - Chrome Molybdenum Steel
  - Supplied in Industry Approved EVA Foam
- Test for hardness with centre punch, only use if indentation is made
- N.B This is not normally suitable for use on security wheel nuts with rotating outer sleeves

Part No.	Description
AFBW71	17mm
AFBW72	18.5mm
AFBW73	20mm
AFBW74	21.5mm
AFBW75	23mm
AFBW76	24.5mm
AFBW77	26mm



1/2"



**Franklin XF 3 pce Impact Universal Joint Set 1/4" 3/8" 1/2" dr**  
**XFI300**

- 1/4" dr
- 3/8" dr
- Heavy Duty 1/2" dr

**Features**

- With Ball & Spring
- Chrome Molybdenum Steel
- Black Phosphate Finish
- Supplied in industry approved EVA foam

Part No.	Description
XFI314	1/4"
XFI338	3/8"
XFI312	1/2"



**Franklin XF 17 pce 6 pt Low Profile Impact Socket Set 1/2" dr**  
**XF14LP**

10 11 12 13 14 15 16 17 18 19 21 22 23 24 27 30 32 x 28mm

**Features**

- 6 Point Low Profile Sockets for working in confined spaces
- Chrome Molybdenum Steel
- Black Phosphate Finish
- Laser etched size markings (for easy identification)
- Supplied in industry approved EVA foam



Part No.	Description
XF1410	10mm
XF1411	11mm
XF1412	12mm
XF1413	13mm
XF1414	14mm
XF1415	15mm
XF1416	16mm
XF1417	17mm
XF1418	18mm
XF1419	19mm
XF1421	21mm
XF1422	22mm
XF1423	23mm
XF1424	24mm
XF1427	27mm
XF1430	30mm
XF1432	32mm



**Franklin XF 14 pce 6 pt Semi Deep Thin Wall Impact Socket Set 3/8" dr**  
**XF16SD**

8 9 10 11 12 13 14 15 16 17 18 19 21 22 x 45mm

**Features**

- 6 Point Semi-Deep Thin Wall Sockets
- Strength of an Impact but Wall Dimension of a standard socket
- Dual Function - Standard or Impact Socket
- Chrome Molybdenum Steel
- Dual Finish and Dual Function
- Black Electro Coated and Satin Finish
- High Visibility Size Markings
- Supplied in industry approved EVA foam



Part No.	Description
XF1608	8mm
XF1609	9mm
XF1610	10mm
XF1611	11mm
XF1612	12mm
XF1613	13mm
XF1614	14mm
XF1615	15mm
XF1616	16mm
XF1617	17mm
XF1618	18mm
XF1619	19mm
XF1621	21mm
XF1622	22mm



**Franklin XF 16 pce 6 pt Low Profile Impact Socket Set 3/8" dr**  
**XF15LP**

6 7 8 9 10 11 12 13 14 15 16 17 18 19 21 22 x 22mm

**Features**

- 6 Point Low Profile Sockets for working in confined spaces
- Chrome Molybdenum Steel
- Black Phosphate Finish
- Laser etched size markings (for easy identification)
- Supplied in industry approved EVA foam



Part No.	Description
XF1506	6mm
XF1507	7mm
XF1508	8mm
XF1509	9mm
XF1510	10mm
XF1511	11mm
XF1512	12mm
XF1513	13mm
XF1514	14mm
XF1515	15mm
XF1516	16mm
XF1517	17mm
XF1518	18mm
XF1519	19mm
XF1521	21mm
XF1522	22mm



**Franklin XF 7 pce 6 pt Semi Deep Thin Wall Impact Socket Set 1/2" dr**  
**XF17SD**

10 11 12 13 14 15 16 x 55mm

**Features**

- 6 Point Semi-Deep Thin Wall Sockets
- Strength of an Impact but Wall Dimension of a standard socket
- Dual Function - Standard or Impact Socket
- Chrome Molybdenum Steel
- Dual Finish and Dual Function
- Black Electro Coated and Satin Finish
- High Visibility Size Markings
- Supplied in industry approved EVA foam.



Part No.	Description
XF1710	10mm
XF1711	11mm
XF1712	12mm
XF1713	13mm
XF1714	14mm
XF1715	15mm
XF1716	16mm





**Franklin XF 8 pce 6 pt Semi Deep Thin Wall Impact Socket Set 1/2" dr**  
**XFI8SD**

17 18 19 21 22 23 24 27 x 55mm

**Features**

- 6 Point Semi-Deep Thin Wall Sockets
- Strength of an Impact but Wall Dimension of a standard socket
- Dual Function - Standard or Impact Socket
- Chrome Molybdenum Steel
- Dual Finish and Dual Function
- Black Electro Coated and Satin Finish
- High Visibility Size Markings
- Supplied in industry approved EVA foam



Part No.	Description
XFI717	17mm
XFI718	18mm
XFI719	19mm
XFI721	21mm
XFI722	22mm
XFI723	23mm
XFI724	24mm
XFI727	27mm



**Franklin XF 10 pce Impact Star Bit Socket Set 3/8" dr**  
**XFIS10**

T10 T15 T20 T25 T27 T30 T40 T45 T50 T55 x 60 mm

**Features**

- For use on Torx type fasteners
- High Grade Chrome Molybdenum Steel
- Black Phosphate Finish
- Laser etched size markings (for easy identification)
- Supplied in industry approved EVA foam



Part No.	Description
FIS10	T10
FIS15	T15
FIS20	T20
FIS25	T25
FIS27	T27
FIS30	T30
FIS40	T40
FIS45	T45
FIS50	T50
FIS55	T55



**Franklin XF 10 pce Impact Hexagon Bit Socket Set 3/8" dr**  
**XFIH10**

6 7 8 9 10 11 12 14 17 19 x 60 mm

**Features**

- High Grade Chrome Molybdenum Steel
- Black Phosphate Finish
- Laser etched size markings (for easy identification)
- Supplied in industry approved EVA foam



Part No.	Description
FIH6	6mm
FIH7	7mm
FIH8	8mm
FIH9	9mm
FIH10	10mm
FIH11	11mm
FIH12	12mm
FIH14	14mm
FIH17	17mm
FIH19	19mm



**Franklin XF 7 pce Impact Hexagon Bit Socket Set 1/2" dr**  
**XFIH7**

10 11 12 13 14 17 19 x 78mm

**Features**

- High Grade Chrome Molybdenum Steel
- Black Phosphate Finish
- Laser etched size markings (for easy identification)
- Supplied in industry approved EVA foam



Part No.	Description
TIH10	10mm
TIH11	11mm
TIH12	12mm
TIH13	13mm
TIH14	14mm
TIH17	17mm
TIH19	19mm



**Franklin XF 7 pce Impact Star Bit Socket Set 1/2" dr**  
**XFIS7**

T50 T55 T60 T70 T80 T90 T100 x 78 mm

**Features**

- For use on Torx type fasteners
- High Grade Chrome Molybdenum Steel
- Black Phosphate Finish
- Laser etched size markings (for easy identification)
- Supplied in industry approved EVA foam

Part No.	Description
TIS50	T50
TIS55	T55
TIS60	T60
TIS70	T70
TIS80	T80
TIS90	T90
TIS100	T100



**Franklin XF 15 pce Socket Set 3/4" sq dr**  
**XF3415**

19 21 22 24 27 28 30 32 33 35 36 38 41 46 50mm

**Features**

- High Grade Chrome Vanadium Steel
- 6 Point Surface Drive
- Roll marked for easy identification
- Supplied in industry approved EVA foam

Part No.	Description
XL3419	19mm
XL3421	21mm
XL3422	22mm
XL3423	23mm Additional Size
XL3424	24mm
XL3426	26mm Additional Size
XL3427	27mm
XL3428	28mm
XL3429	29mm Additional Size
XL3430	30mm
XL3432	32mm
XL3433	33mm
XL3435	35mm
XL3436	36mm
XL3438	38mm
XL3441	41mm
XL3446	46mm
XL3450	50mm



**Franklin 4 pce Impact Spline Bit Set 1/2" dr**  
**XFIX4**

- M12 - VW Touran Rear Hubs
- M14 - VW LT / Transporter Ball Joints
- M16 (Tamperproof) - VW Sharan Rear Hubs
- M18 (Tamperproof) - VW Golf Rear Hubs
- 1/2 dr x 78mm - Suitable for general use

**Features**

- High Grade Chrome Molybdenum Steel
- Impact Quality Black Phosphate Finish
- Manufactured to DIN Standards
- Supplied in industry approved EVA foam

Part No.	Description
81412	Spline M12
81414	Spline M14
81416	Tamper Spline M16
81418	Tamper Spline M18



**Franklin XF 90T Low Profile Ratchet 1/2" dr**  
**XFR190**

**Features**

- Low Profile Compact Head - Ideal for working in confined spaces
- 90 Teeth Reversible Ratchet Head
- Quick Release
- High Grade Chrome Vanadium Steel
- Mirror finish
- Manufactured to DIN Standards
- Supplied in industry approved EVA foam





**Franklin XF 2 pce 90T Low Profile Ratchet 1/4" 3/8" dr**  
**XFR290**

XFR490 - Franklin XF 90T Low Profile Ratchet 1/4" dr  
XFR390 - Franklin XF 90T Low Profile Ratchet 3/8" dr

**Features**

- 1/4" dr 90 Teeth Ratchet
- 3/8" dr 90 Teeth Ratchet
- Quick Release
- High Grade Chrome Vanadium Steel
- Mirror finish
- Manufactured to DIN Standards
- Supplied in industry approved EVA foam



1/4" 3/8"



Part No.	Description
XFR490	1/4"
XFR390	3/8"

**Franklin XF 3 pce 72 Teeth Extending Ratchet Set 1/4" 3/8" 1/2" dr**  
**XFR3E**

- XF1408 148-198mm 1/4" dr
- XF3808 218-316mm 3/8" dr
- XF1208 300-400mm 1/2" dr

**Features**

- 72 Teeth Reversible Ratchet Head
- Extending Shaft
- Quick Release
- High Grade Chrome Vanadium Steel
- Mirror finish
- Supplied in industry approved EVA foam
- Ratchet Service Kits available
- 400 Series - Build Your Own Tool Box  
400mm x 150mm EVA Foam Module



1/4" 3/8" 1/2" 400 SERIES



Part No.	Description
XF1408	1/4"
XF3808	3/8"
XF1208	1/2"

**Franklin XF 3 pce 72 Teeth Ratchet Set 1/4" 3/8" 1/2" dr**  
**XFR372**

XF1403 1/4" x 145 mm  
XF3803 3/8" x 200 mm  
XF1203 1/2" x 245 mm

**Features**

- 72 Teeth Reversible Ratchet Head
- Quick Release
- High Grade Chrome Vanadium Steel
- Mirror finish
- Supplied in industry approved EVA foam
- Ratchet Service kits available



1/4" 3/8" 1/2"



Part No.	Description
XF1403	1/4"
XF3803	3/8"
XF1203	1/2"

**Franklin XF 3 pce 72 Teeth Flexi Extending Ratchet Set 1/4" 3/8" 1/2" dr**  
**XFR3F**

XF1409 175-225mm 1/4" dr  
XF3809 240-340mm 3/8" dr  
XF1209 345-495mm 1/2" dr

**Features**

- 72 Teeth Reversible Ratchet Head
- Indexing and Extending Shaft
- Quick Release
- High Grade Chrome Vanadium Steel
- Mirror finish
- Supplied in industry approved EVA foam
- Ratchet Service kits available
- 400 Series - Build Your Own Tool Box  
400mm x 150mm EVA Foam Module



1/4" 3/8" 1/2" 400 SERIES



Part No.	Description
XF1409	1/4"
XF3809	3/8"
XF1209	1/2"

**Franklin XF 3 pce Fully Polished Ratchet Set 1/4" 3/8" 1/2" dr**  
**XFRP3**

XFRP14 1/4" dr x 152mm  
XFRP38 3/8" dr x 202mm  
XFRP12 1/2" dr x 250mm

**Features**

- Low Profile Compact Head - Ideal for working in confined spaces
- 72 Teeth Reversible Ratchet Head
- High Grade Chrome Vanadium Steel
- Mirror finish
- Supplied in industry approved EVA foam
- Ratchet Service kits available



1/4" 3/8" 1/2"

Part No.	Description
XFRP14	1/4"dr
XFRP38	3/8"dr
XFRP12	1/2"dr



**Franklin XF 3 in 1 Ratchet 60T Set**  
**XLR123**

Ratchet Handle with Interchangeable Quick Release Heads - 1/4", 3/8", 1/2"

**Features**

- High Grade Chrome Vanadium Steel
- Mirror finish with Comfort Grip Handle
- 60T Ratchet Heads with Quick Release
- 230mm Reversible Handle
- Supplied in a sturdy Blow Mold case



1/4" 3/8" 1/2"



**Franklin XF 3 pce 72 Teeth Low Profile Flexible Ratchet Set**  
**1/4" 3/8" 1/2" dr**  
**XFRF3**

XFRF14 1/4" dr x 170mm  
XFRF38 3/8" dr x 315mm  
XFRF12 1/2" dr x 410mm

**Features**

- Low Profile Compact Head - Ideal for working in confined spaces
- 72 Teeth Reversible Ratchet Head
- Flexible Ratchet Head
- High Grade Chrome Vanadium Steel
- Mirror finish
- Supplied in industry approved EVA foam
- Ratchet Service kits available
- 400 Series - Build Your Own Tool Box  
400mm x 150mm EVA Foam Module



1/4" 3/8" 1/2" 400 SERIES

Part No.	Description
XFRF2	2 pce Set 1/4" 3/8" dr
XFRF14	1/4"
XFRF38	3/8"
XFRF12	1/2"



**Franklin XF Ratchet Service Kits**

The following Service Kits are available:

- XFRR14 for Ratchet XFRF14 (early pattern with circlip retainer)
- XFRR38 for Ratchet XFRF38 (early pattern with circlip retainer)
- XFRR12 for Ratchet XFRF12 (early pattern with circlip retainer)
- XF1493 for Ratchets XF1408, XF1409 and XF1403
- XF3893 for Ratchets XF3808, XF3809 and XF3803
- XF1293 for Ratchets XF1208, XF1209 and XF1203
- XFRS14 for Ratchets XFRP14 and XFRF14 (later pattern with 2 retaining screws)
- XFRS38 for Ratchets XFRP38 and XFRF38 (later pattern with 2 retaining screws)
- XFRS12 for Ratchets XFRP12 and XFRF12 (later pattern with 2 retaining screws)

Part No.	Description
XFRR14	1/4" dr
XFRR38	3/8" dr
XFRR12	1/2" dr
XF1493	1/4" dr
XF3893	3/8" dr
XF1293	1/2" dr
XFRS14	1/4" dr
XFRS38	3/8" dr
XFRS12	1/2" dr



1/4" 3/8" 1/2"





**Franklin 4 pce Power Bar / Extension Bar Set**  
**XFA100**

- Power Bar 3/8" dr 450mm
- Power Bar 1/2" dr 600mm
- Extension Bar 3/8" dr 600mm
- Extension Bar 1/2" dr 600mm

**Features**

- High Grade Chrome Vanadium Steel
- Mirror finish with Anti-Slip Knurl (extensions only)
- Supplied in industry approved EVA foam

Part No.	Description
12E600	600mm x 1/2" dr
38E600	600mm x 3/8" dr
TA720	600mm x 1/2" dr
FT3818	450mm x 3/8" dr



3/8" 1/2"



**Franklin XF 6 pce Converter Reducer Set**  
**XFA200**

**Drive Converters/Adaptors**

- 1/4" F x 3/8" M
- 3/8" F x 1/4" M
- 3/8" F x 1/2" M
- 1/2" F x 3/8" M
- 1/2" F x 3/4" M
- 3/4" F x 1/2" M

**Features**

- High Grade Chrome Vanadium Steel
- Mirror finish
- Supplied in industry approved EVA foam

Part No.	Description
FT1438	1/4" F x 3/8" M 3/8" F x 1/4" M
FT1238	3/8" F x 1/2" M
FT3812	1/2" F x 3/8" M
FT1234	3/4" F x 1/2" M
FT3412	1/2" F x 3/4" M



1/4" 3/8" 1/2" 3/4"



**Franklin XF 16 pce Bit Holder & Socket Adaptor Set**  
**XFA16**

**Bit Holder Sockets/Adaptors**

- 1/4" Hexagon x 1/4" dr
- 8mm Hexagon x 1/4" dr and 3/8" dr
- 10mm Hexagon x 3/8" dr and 1/2" dr
- 1/4" Hexagon Magnetic Bit Holder x 60mm
- 1/4" Hexagon Quick Release Bit Holder

**Drive Converters/Adaptors**

- 1/4" F x 3/8" M
- 3/8" F x 1/4" M
- 3/8" F x 1/2" M
- 1/2" F x 3/8" M
- 1/2" F x 3/4" M
- 3/4" F x 1/2" M

**Socket Drivers/Adaptors**

- 1/4" Hexagon x 1/4" dr
- 1/4" Hexagon x 3/8" dr
- 1/4" Hexagon x 1/2" dr

**Features**

- High Grade Chrome Vanadium Steel Sockets
- CR-MO Socket Drivers/Adaptors
- Supplied in industry approved EVA foam

Part No.	Description
TP114	1/4" Hex 1/4" dr
TP214	8mm Hex 1/4" dr
TP238	8mm Hex 3/8" dr
TP138	10mm Hex 3/8" dr
TP312	10mm Hex 1/2" dr
TP6MAG	60mm Magnetic Bit Holder
TP6QRM	60mm Quick Release Bit Holder
4130	3 pce Socket Drivers Set
FT1438	1/4" F x 3/8" M 3/8" F x 1/4" M
FT1238	3/8" F x 1/2" M
FT3812	1/2" F x 3/8" M
FT1234	3/4" F x 1/2" M
FT3412	1/2" F x 3/4" M



1/4" 3/8" 1/2" 3/4"



**Franklin XF 10 pce Wobble Extension Bar Set 1/4" 3/8" 1/2" dr**  
**XFWE10**

- 1/4" x 50, 100, 150mm
- 3/8" x 35, 75, 150, 250mm
- 1/2" x 50, 125, 250mm

- Features**
- High Grade Chrome Vanadium Steel
  - Mirror finish with Anti-Slip Knurl
  - Manufactured to ANSI Standards
  - Supplied in industry approved EVA foam



1/4" 3/8" 1/2"

Part No.	Description
FT1403	1/4" dr x 50mm
FT1406	1/4" dr x 100mm
FT1407	1/4" dr x 150mm
FT3800	3/8" dr x 35mm
FT3803	3/8" dr x 75mm
FT3806	3/8" dr x 150mm
FT3809	3/8" dr x 250mm
FT1202	1/2" dr x 50mm
FT1205	1/2" dr x 125mm
FT1210	1/2" dr x 250mm



**Franklin XF 6 pce Two Stage Wobble and Fixed Extension Bar Set 1/4" dr**  
**XF1476**

50 75 100 150 250 350mm

- Features**
- High Grade Chrome Vanadium Steel
  - Mirror finish with Anti-Slip Knurl
  - Manufactured to ANSI Standards
  - Supplied in industry approved EVA foam



1/4"

Part No.	Description
14W50	50mm
14W75	75mm
14W100	100mm
14W150	150mm
14W250	250mm
14W350	350mm



**Franklin XF 6 pce Extension Bar Set 1/4" dr**  
**XF1466**

50 75 100 150 250 350mm

- Features**
- High Grade Chrome Vanadium Steel
  - Mirror finish with Anti-Slip Knurl
  - Manufactured to ANSI Standards
  - Supplied in industry approved EVA foam



1/4"

Part No.	Description
14E50	50mm
14E75	75mm
14E100	100mm
14E150	150mm
14E250	250mm
14E350	350mm



**Franklin XF 6 pce Impact Extension Bar Set 1/4" dr**  
**XF1496**

50 75 100 150 250 350mm

- Features**
- High Grade Chrome Molybdenum Steel
  - Impact Quality
  - Black Phosphate Finish
  - Manufactured to ANSI Standards
  - Supplied in industry approved EVA foam



1/4"

Part No.	Description
14P50	50mm
14P75	75mm
14P100	100mm
14P150	150mm
14P250	250mm
14P350	350mm





**Franklin XF 5 pce Extension Bar Set 3/8" dr**  
**XF3865**

50 75 150 250 350mm  
600mm x 3/8" dr Additional Size Available - Part No. 38E600

- Features**
- High Grade Chrome Vanadium Steel
  - Mirror finish with Anti-Slip Knurl
  - Manufactured to ANSI Standards
  - Supplied in industry approved EVA foam

Part No.	Description
38E50	50mm
38E75	75mm
38E150	150mm
38E250	250mm
38E350	350mm
38E600	600mm Additional Size



3/8"



**Franklin XF 5 pce Impact Extension Bar Set 3/8" dr**  
**XF3895**

50 75 150 250 350mm

- Features**
- High Grade Chrome Molybdenum Steel
  - Impact Quality
  - Black Phosphate Finish
  - Manufactured to ANSI Standards
  - Supplied in industry approved EVA foam

Part No.	Description
38P50	50mm
38P75	75mm
38P150	150mm
38P250	250mm
38P350	350mm



3/8"



**Franklin XF 5 pce Two Stage Wobble and Fixed Extension Bar Set 3/8" dr**  
**XF3875**

50 75 150 250 350mm

- Features**
- High Grade Chrome Vanadium Steel
  - Mirror Finish with Anti-Slip Knurl
  - Manufactured to ANSI Standards
  - Supplied in industry approved EVA foam

Part No.	Description
38W35	35mm Additional Size
38W50	50mm
38W75	75mm
38W150	150mm
38W250	250mm
38W350	350mm
FT3817	450mm Additional Size



3/8"



**Franklin XF 5 pce Extension Bar Set 1/2" dr**  
**XF1265**

50 75 150 250 375mm  
600mm x 1/2" dr Additional Size Available - Part No. 12E600

- Features**
- High Grade Chrome Vanadium Steel
  - Mirror finish with Anti-Slip Knurl
  - Manufactured to ANSI Standards
  - Supplied in industry approved EVA foam

Part No.	Description
12E50	50mm
12E75	75mm
12E150	150mm
12E250	250mm
12E375	375mm
12E600	600mm Additional Size



1/2"



## Franklin XF 5 pce Two Stage Wobble and Fixed Extension Bar Set 1/2" dr

### XF1275

50 75 150 250 375mm

#### Features

- High Grade Chrome Vanadium Steel
- Mirror Finish with Anti-Slip Knurl
- Manufactured to ANSI Standards
- Supplied in industry approved EVA foam

Part No.	Description
12W50	50mm
12W75	75mm
12W125	125mm Additional Size
12W150	150mm
12W250	250mm
12W375	375mm
FT1217	450mm Additional Size



1/2"

FRANKLIN  
Professional Quality Tools

## Franklin XF 5 pce Impact Extension Bar Set 1/2" dr

### XF1295

50 75 150 250 375mm

#### Features

- High Grade Chrome Molybdenum Steel
- Impact Quality
- Black Phosphate Finish
- Manufactured to ANSI Standards
- Supplied in industry approved EVA foam

Part No.	Description
12P50	50mm
12P75	75mm
12P150	150mm
12P250	250mm
12P375	375mm



1/2"

FRANKLIN  
Professional Quality Tools



## Contents

Spanners Non Ratcheting	C2
Spanners Ratcheting	C3
Crowfoot Spanners	C8
Pliers	C10
Circlip Pliers	C14
GripJaw Pliers	C15
Screwdrivers	C19
Bit Sets	C22

**FF Franklin & Co Ltd**

Platt Street

Sheffield

S3 8BQ

England

**Telephone**

0114 272 1429

**Facsimile**

0114 272 7030

**Email**

orders@franklin-tools.co.uk

**Tools in EVA Modules**  
**2020**

**www.franklin-tools.co.uk**

**Gear F Grip 4+ 10 pce 12 pt XL Combination Spanner Set AF7100**

10 11 12 13 14 15 16 17 18 19mm

**Features**

- Grip4+ Non-Slip Open End improves grip and reduces slip
- 12 Point Surface Drive Ring End drives on the flats for better grip
- Small Head Profile for working in confined spaces
- 15° Offset Box End allows better access to fasteners
- High Grade Chrome Vanadium Steel
- Mirror Finish and Plated to Prevent Corrosion
- Manufactured to DIN Standards
- GearF - Franklin Lifetime Warranty
- 400 Series - Build Your Own Tool Box  
400mm x 200mm EVA Foam Module
- Supplied in industry approved EVA foam



**400**  
SERIES

**12PT**



Part No.	Description
AF7110	10mm
AF7111	11mm
AF7112	12mm
AF7113	13mm
AF7114	14mm
AF7115	15mm
AF7116	16mm
AF7117	17mm
AF7118	18mm
AF7119	19mm



**Gear F Grip 4+ 5 pce 12 pt XL Combination Spanner Set AF7105**

6 7 8 9 10mm

**Features**

- Grip4+ Non-Slip Open End improves grip and reduces slip
- 12 Point Surface Drive Ring End drives on the flats for better grip
- Small Head Profile for working in confined spaces
- 15° Offset Box End allows better access to fasteners
- High Grade Chrome Vanadium Steel
- Mirror Finish and Plated to Prevent Corrosion
- Manufactured to DIN Standards
- GearF - Franklin Lifetime Warranty
- Supplied in industry approved EVA foam



**12PT**



Part No.	Description
AF7106	6mm
AF7107	7mm
AF7108	8mm
AF7109	9mm
AF7110	10mm



**Gear F Grip 4+ 7 pce 12 pt XL Combination Spanner Set AF7101**

20 21 22 24 27 30 32mm

**Features**

- Grip4+ Non-Slip Open End improves grip and reduces slip
- 12 Point Surface Drive Ring End drives on the flats for better grip
- Small Head Profile for working in confined spaces
- 15° Offset Box End allows better access to fasteners
- High Grade Chrome Vanadium Steel
- Mirror Finish and Plated to Prevent Corrosion
- Manufactured to DIN Standards
- GearF - Franklin Lifetime Warranty
- Supplied in industry approved EVA foam



**12PT**



Part No.	Description
AF7120	20mm
AF7121	21mm
AF7122	22mm
AF7124	24mm
AF7127	27mm
AF7130	30mm
AF7132	32mm



**Gear F 10 pce 12 pt Stubby Ratchet Spanner Set AF7200**

10 11 12 13 14 15 16 17 18 19mm

**Features**

- 72-Teeth Ratchet End only requires 5° to move fasteners
- 12 Point Surface Drive Ring End drives on the flats for better grip
- Small Head Profile for working in confined spaces
- High Grade Chrome Vanadium Steel
- Mirror Finish and Plated to Prevent Corrosion
- Manufactured to DIN Standards
- GearF - Franklin Lifetime Warranty
- Supplied in industry approved EVA foam



**12PT**



Part No.	Description
AF7210	10mm
AF7211	11mm
AF7212	12mm
AF7213	13mm
AF7214	14mm
AF7215	15mm
AF7216	16mm
AF7217	17mm
AF7218	18mm
AF7219	19mm





**Gear F Grip 4+ 10 pce 12 pt Combination Ratchet Spanner Set AF7300**

10 11 12 13 14 15 16 17 18 19mm

**Features**

- Grip4+ Non-Slip Open End improves grip and reduces slip
- 72-Teeth Ratchet End only requires 5° to move fasteners
- 12 Point Surface Drive Ring End drives on the flats for better grip
- Small Head Profile for working in confined spaces
- High Grade Chrome Vanadium Steel
- Mirror Finish and Plated to Prevent Corrosion
- Manufactured to DIN Standards
- GearF - Franklin Lifetime Warranty
- 400 Series - Build Your Own Tool Box  
400mm x 200mm EVA Foam Module
- Supplied in industry approved EVA foam



Part No.	Description
AF7310	10mm
AF7311	11mm
AF7312	12mm
AF7313	13mm
AF7314	14mm
AF7315	15mm
AF7316	16mm
AF7317	17mm
AF7318	18mm
AF7319	19mm



**Gear F Grip 4+ 5 pce 12 pt Combination Ratchet Spanner Set AF7305**

6 7 8 9 10mm

**Features**

- Grip4+ Non-Slip Open End improves grip and reduces slip
- 72-Teeth Ratchet End only requires 5° to move fasteners
- 12 Point Surface Drive Ring End drives on the flats for better grip
- Small Head Profile for working in confined spaces
- High Grade Chrome Vanadium Steel
- Mirror Finish and Plated to Prevent Corrosion
- Manufactured to DIN Standards
- GearF - Franklin Lifetime Warranty
- Supplied in industry approved EVA foam



Part No.	Description
AF7306	6mm
AF7307	7mm
AF7308	8mm
AF7309	9mm
AF7310	10mm



**Gear F Grip 4+ 4 pce 12 pt Combination Ratchet Spanner Set AF7304**

21 22 24 27mm

**Features**

- Grip4+ Non-Slip Open End improves grip and reduces slip
- 72-Teeth Ratchet End only requires 5° to move fasteners
- 12 Point Surface Drive Ring End drives on the flats for better grip
- Small Head Profile for working in confined spaces
- High Grade Chrome Vanadium Steel
- Mirror Finish and Plated to Prevent Corrosion
- Manufactured to DIN Standards
- GearF - Franklin Lifetime Warranty
- 400 Series - Build Your Own Tool Box  
400mm x 200mm EVA Foam Module
- Supplied in industry approved EVA foam



Part No.	Description
AF7321	21mm
AF7322	22mm
AF7324	24mm
AF7327	27mm



**Gear F 10 pce 12 pt Ratchet Open End Combination Spanner Set AF7400**

10 11 12 13 14 15 16 17 18 19mm

**Features**

- Allows Ratcheting without removing Wrench from fastener
- 72-Teeth Ratchet End only requires 5° to move fasteners
- 12 Point Surface Drive Ring End drives on the flats for better grip
- High Grade Chrome Vanadium Steel
- Mirror Finish and Plated to Prevent Corrosion
- Manufactured to DIN Standards
- GearF - Franklin Lifetime Warranty
- 400 Series - Build Your Own Tool Box  
400mm x 200mm EVA Foam Module
- Supplied in industry approved EVA foam



Part No.	Description
AF7410	10mm
AF7411	11mm
AF7412	12mm
AF7413	13mm
AF7414	14mm
AF7415	15mm
AF7416	16mm
AF7417	17mm
AF7418	18mm
AF7419	19mm



**Gear F 10 pce 12 pt Flexi Ratchet Combination Spanner Set AF7500**

10 11 12 13 14 15 16 17 18 19mm

**Features**

- Flexi Head tilts 180° at any interval with continuous head tension
- 72-Teeth Ratchet End only requires 5° to move fasteners
- 12 Point Surface Drive Ring End drives on the flats for better grip
- Small Head Profile for working in confined spaces
- High Grade Chrome Vanadium Steel
- Mirror Finish and Plated to prevent corrosion
- Manufactured to DIN Standards
- GearF - Franklin Lifetime Warranty
- 400 Series - Build Your Own Tool Box  
400mm x 200mm EVA Foam Module
- Supplied in industry approved EVA foam



Part No.	Description
AF7510	10mm
AF7511	11mm
AF7512	12mm
AF7513	13mm
AF7514	14mm
AF7515	15mm
AF7516	16mm
AF7517	17mm
AF7518	18mm
AF7519	19mm



**Gear F 5 pce 12 pt Flexi Ratchet Combination Spanner Set AF7505**

6 7 8 9 10mm

**Features**

- Flexi Head tilts 180° at any interval with continuous head tension
- 72-Teeth Ratchet End only requires 5° to move fasteners
- 12 Point Surface Drive Ring End drives on the flats for better grip
- Small Head Profile for working in confined spaces
- High Grade Chrome Vanadium Steel
- Mirror Finish and Plated to prevent corrosion
- Manufactured to DIN Standards
- GearF - Franklin Lifetime Warranty
- Supplied in industry approved EVA foam



Part No.	Description
AF7506	6mm
AF7507	7mm
AF7508	8mm
AF7509	9mm
AF7510	10mm



**Gear F 4pce 12pt Flexi Ratchet Combination Spanner Set AF7504**

21 22 24 27mm

**Features**

- Flexi Head tilts 180° at any interval with continuous head tension
- 72-Teeth Ratchet End only requires 5° to move fasteners
- 12 Point Surface Drive Ring End drives on the flats for better grip
- Small Head Profile for working in confined spaces
- High Grade Chrome Vanadium Steel
- Mirror Finish and Plated to Prevent Corrosion
- Manufactured to DIN Standards
- GearF - Franklin Lifetime Warranty
- 400 Series - Build Your Own Tool Box  
400mm x 200mm EVA Foam Module
- Supplied in industry approved EVA foam



Part No.	Description
AF7521	21mm
AF7522	22mm
AF7524	24mm
AF7527	27mm



**Gear F 12 pce 12 pt Reversible Ratchet Combination Spanner Set AF7600**

8 9 10 11 12 13 14 15 16 17 18 19mm

**Features**

- Compact Reversible Switch enables wrench to move in either direction (clockwise or counterclockwise) without sacrificing overall compact surface box end.
- 15° Offset Ratchet Head helps to reduce swing obstacles and to minimise knuckle fatigue.
- 72-Teeth Ratchet End only requires 5° to move fasteners.
- 12 Point Surface Drive Ring End drives on the flats for better grip.
- High Grade Chrome Vanadium Steel
- Mirror Finish and Plated to Prevent Corrosion
- Manufactured to DIN Standards.
- GearF - Franklin Lifetime Warranty
- 400 Series - Build Your Own Tool Box  
400mm x 200mm EVA Foam Module
- Supplied in industry approved EVA foam



Part No.	Description
AF7608	8mm
AF7609	9mm
AF7610	10mm
AF7611	11mm
AF7612	12mm
AF7613	13mm
AF7614	14mm
AF7615	15mm
AF7616	16mm
AF7617	17mm
AF7618	18mm
AF7619	19mm





**Gear F 13 pce Crowfoot Wrench Set 3/8" dr**  
**AF7900**

10 11 12 13 14 15 16 17 18 19 21 22 24mm

**Features**

- High quality Chrome Vanadium Steel
- Mirror Finish
- Plated to prevent corrosion
- Individually size marked for easy identification
- 3/8" Square drive
- GearF - Franklin Lifetime Warranty
- Supplied in industry approved EVA foam



Part No.	Description
790010	10mm
790011	11mm
790012	12mm
790013	13mm
790014	14mm
790015	15mm
790016	16mm
790017	17mm
790018	18mm
790019	19mm
790021	21mm
790022	22mm
790024	24mm

3/8"



**Gear F 7 pce 12pt Crowfoot Wrench Set 1/2" dr**  
**AF7970**

20 21 22 24 27 30 32mm

**Features**

- High quality Chrome Vanadium Steel
- Mirror Finish
- Plated to prevent corrosion
- Individually size marked for easy identification
- 1/2" Square drive
- GearF - Franklin Lifetime Warranty
- Supplied in industry approved EVA foam



1/2"



**Gear F 10 pce 12pt Crowfoot Wrench Set 3/8" dr**  
**AF7950**

10 11 12 13 14 15 16 17 18 19mm

**Features**

- High quality Chrome Vanadium Steel
- Mirror Finish
- Plated to prevent corrosion
- Individually size marked for easy identification
- 3/8" Square drive
- GearF - Franklin Lifetime Warranty
- Supplied in industry approved EVA foam



3/8"



Sign up online at <https://www.franklin-tools.co.uk/register>

**Why become a Franklin Tool account holder?**

- You will be able to log into your account to check product availability and place orders 24 hours a day
- See our latest promotions and distributor exclusive offers
- Take advantage of our "Quick Order" facility by entering your part number and the quantity you require
- For your regular stock items, select products from previous orders using our "Cherry Pick" facility

**Irwin 2 pce Vise Grip Plier Set  
AF214**

- 7" Curve Jaw with Wire Cutter
- 10" Curve Jaw with Wire Cutter

**Features**

- Self-Energising Lower Jaw giving 3X more gripping power
- Fast Release Handle
- Protouch Grips for comfort and control
- Hex key adjusting screw
- Supplied in industry approved EVA foam



Part No.	Description
AT07T	7WR
AT05T	10WR



**Gear F 3 pce Water Pump Pliers  
GFFP3**

10" 12" 16"

**Features**

- Heavy Duty Water Pump Pliers
- Quick Action Size Adjustment
- Ergonomic Comfort Grips
- Chrome Vanadium Steel
- Hardened and Tempered Teeth
- Black Satin Finish
- GearF - Franklin Lifetime Warranty
- Supplied in industry approved EVA foam



Part No.	Description
FP2	10" and 12"
FP16	16"

**Gear F Straight Jaw Water Pump Pliers**

- 16" Straight Jaw Water Pump Plier
- 20" Straight Jaw Water Pump Plier

**Features**

- High quality Steel Jaw
- Drop Forged Hardened and Tempered High Grade Steel
- Gripping surfaces with special hardened teeth
- Ergonomic handles for comfort and grip
- GearF - Franklin Lifetime Warranty



Part No.	Description
GF016	16"
GF020	20"



**Gear F 3pce 8" Plier Set  
GF308**

- 8" Long Nose Plier
- 8" Heavy Duty Side Cutting Plier
- 8" Combination Plier

**Features**

- Drop Forged Hardened and Tempered High Grade Steel
- Cutting edges additionally Induction Hardened for extra sharpness and Durability
- Plated Finish
- Ergonomic handles for comfort and grip
- GearF - Franklin Lifetime Warranty
- 400 Series - Build Your Own Tool Box
- 400mm x 150mm EVA Foam Module
- Supplied in industry approved EVA foam



**400  
SERIES**



Part No.	Description
GF3081	Long Nose Plier
GF3082	Heavy Duty Side Cutting Plier
GF3083	Combination Plier



**Gear F 3 pce Quick Action Water Pump Plier Set  
GF310**

- 7" Plier
- 10" Plier
- 12" Plier

**Features**

- Self-locking Push Button for faster size selection
- Fine-Groove Ratcheting System For Precise Positioning and Optimum adjustment
- Gripping surfaces with special hardened teeth
- Guard prevents operators' fingers being pinched
- Non-Slip handles for comfort and grip
- High quality Chrome Vanadium Steel Jaw
- Drop Forged Hardened and Tempered High Grade Steel
- GearF - Franklin Lifetime Warranty
- 400 Series - Build Your Own Tool Box  
400mm x 200mm EVA Foam Module
- Supplied in industry approved EVA foam

Part No.	Description
GF3101	7"
GF3102	10"
GF3103	12"



**400**  
SERIES



**Gear F 3 pce 13" Compound Joint Long Reach Plier Set  
GF313**

- Long Nose Plier
- 45° Bent Nose Plier
- Flat Nose Gripping Plier

**Features**

- Drop Forged Hardened and Tempered High Grade Steel
- Compound Joint allows for greater access with minimal handle movement
- Perfect for tight locations where wide jaw opening is needed
- Flush riveted joint improves access in confined spaces
- Satin Finish
- Ergonomic handles for comfort and grip
- GearF - Franklin Lifetime Warranty
- 400 Series - Build Your Own Tool Box  
400mm x 150mm EVA Foam Module
- Supplied in industry approved EVA foam

Part No.	Description
GF3131	Long Nose
GF3132	45° Bent Nose
GF3133	Flat Nose



**400**  
SERIES



**Gear F 3 pce 11" Long Reach Plier Set  
GF311**

- Long Nose Plier
- Side Cutting Plier
- 45° Bent Nose Plier

**Features**

- Drop Forged Hardened and Tempered High Grade Steel
- Flush riveted joint improves access in confined spaces
- Satin Finish
- Ergonomic handles for comfort and grip
- GearF - Franklin Lifetime Warranty
- 400 Series - Build Your Own Tool Box  
400mm x 150mm EVA Foam Module
- Supplied in industry approved EVA foam

Part No.	Description
GF3111	Long Nose
GF3112	Side Cutting
GF3113	45° Bent Nose



**400**  
SERIES



**Gear F 3 pce 16" Long Reach Plier Set  
GF316**

- Long Nose Plier
- 45° Bent Nose Plier
- 90° Bent Nose Plier

**Features**

- Drop Forged Hardened and Tempered High Grade Steel
- Flush riveted joint improves access in confined spaces
- Satin Finish
- Ergonomic handles for comfort and grip
- GearF - Franklin Lifetime Warranty
- Supplied in industry approved EVA foam

Part No.	Description
GF3161	Long Nose
GF3162	45° Bent Nose
GF3163	90° Bent Nose



**Gear F 4 pce 7" Circlip Plier Set  
GF407**

- 7" Straight Internal Plier
- 7" Bent Internal Plier
- 7" Straight External Plier
- 7" Bent External Plier

**Features**

- Drop Forged Hardened and Tempered High Grade Steel
- Anti-Slip turned precision tips
- Ergonomic handles for comfort and grip
- GearF - Franklin Lifetime Warranty
- 400 Series - Build Your Own Tool Box  
400mm x 200mm EVA Foam Module
- Supplied in industry approved EVA foam



Part No.	Description
GF4071	Straight Internal
GF4072	Bent Internal
GF4073	Straight External
GF4074	Bent External



**400**  
SERIES

**Gear F 4 pce Circlip Plier Set 13"  
GF413**

- 13" Straight Internal Plier
- 13" Bent Internal Plier
- 13" Straight External Plier
- 13" Bent External Plier

Capacity - 80-150mm  
Tip Diameter - 3.2mm

**Features**

- Chrome Vanadium Steel
- Anti-Slip turned precision tips
- Ergonomic handles for comfort and grip
- GearF - Franklin Lifetime Warranty
- 400 Series - Build Your Own Tool Box  
400mm x 300mm EVA Foam Module
- Supplied in industry approved EVA foam



**400**  
SERIES

Part No.	Description
GF4131	Internal Straight
GF4132	Internal Bent
GF4133	External Straight
GF4134	External Bent

**Gear F 4 pce Circlip Plier Set 9"  
GF409**

- 9" Straight Internal Plier
- 9" Bent Internal Plier
- 9" Straight External Plier
- 9" Bent External Plier

Capacity - 40-90mm  
Tip Diameter - 2.3mm

**Features**

- Chrome Vanadium Steel
- Anti-Slip turned precision tips
- Ergonomic handles for comfort and grip
- GearF - Franklin Lifetime Warranty
- 400 Series - Build Your Own Tool Box  
400mm x 250mm EVA Foam Module
- Supplied in industry approved EVA foam



**400**  
SERIES

Part No.	Description
GF4091	Internal Straight
GF4092	Internal Bent
GF4093	External Straight
GF4094	External Bent

**Gear F 2 pce Parrot Jaw Set 7" and 9"  
GFG2P**

Heavy duty jaws lock on to three sides of a hex fastener or round parts and will not slip or mar

**Features**

- Serrated jaws produce a strong grip
- For use on rounded hex fasteners
- Screw tension adjustment
- Stays adjusted for repetitive use
- Chrome Molybdenum Steel
- Satin finish
- Use for rusted, stripped, stubborn and non-standard fasteners
- Quick Release action
- Ergonomic Handles for comfort in use
- GearF - Franklin Lifetime Warranty
- Supplied in Industry Approved EVA Foam



Part No.	Description
GFG7P	7"
GFG9P	9"



**Gear F 3 pce Grip-Jaw Plier Set  
GFGJ1**

- 10" Curved Jaw with wire cutter
- 6" Long Nose Jaw
- 5" Curved Jaw with wire cutter

**Features**

- Screw Tension Adjustment
- Quick Release Action
- Hardened and Tempered Jaw
- Ergonomic Grips
- Satin Finish
- GearF - Franklin Lifetime Warranty
- 400 Series - Build Your Own Tool Box  
400mm x 150mm EVA Foam Module
- Supplied in industry approved EVA foam

Part No.	Description
GFG5W	5" Curved Jaw with wire cutter
GFG6L	6" Long nose
GFG10W	10" Curved Jaw with wire cutter



**400**  
SERIES



**Gear F 3 pce Grip-Jaw Plier Mechanics Set  
GFGJ3**

- 10" - 250 mm Long Jaw
- 11" - 275 mm C Clamp
- 11" - 275 mm Hose Clamp

**Features**

- Screw Tension Adjustment
- Quick Release Action
- Hardened and Tempered Jaw
- Ergonomic Grips
- Satin Finish
- GearF - Franklin Lifetime Warranty
- 400 Series - Build Your Own Tool Box  
400mm x 200mm EVA Foam Module
- Supplied in industry approved EVA foam

Part No.	Description
GFG10L	10" Long Jaw
GFG11H	11" Hose Clamp
GFG11C	11" C Clamp



**400**  
SERIES

**Gear F 3 pce Grip Jaw Plier Set  
GFGJ2**

- 7" Curved Jaw with wire cutter
- 9" Long Nose Jaw
- 10" Straight Jaw

**Features**

- Screw Tension Adjustment
- Quick Release Action
- Hardened and Tempered Jaw
- Ergonomic Grips
- Satin Finish
- GearF - Franklin Lifetime Warranty
- 400 Series - Build Your Own Tool Box  
400mm x 150mm EVA Foam Module
- Supplied in industry approved EVA foam

Part No.	Description
GFG7W	7" Curved Jaw with wire cutter
GFG9L	9" Long nose
GFG10R	10" Straight Jaw



**400**  
SERIES



**Gear F 3 pce Grip Jaw Locking Plier Set - Soft Grip  
GFGJ5**

- GFS7R - 7" Straight Jaw
- GFS9L - 9" Long Nose with Wire Cutter
- GFS10W - 10" Curved Jaw with Wire Cutter

**Features**

- Chrome Vanadium Steel Jaws
- Ergonomic Soft Grip Handles for extra comfort in use
- Satin Finish
- Quick Release
- Adjusting Screw
- GearF - Franklin Lifetime Warranty
- 400 Series - Build Your Own Tool Box  
400mm x 150mm EVA Foam Module
- Supplied in industry approved EVA foam

Part No.	Description
GFS7R	7" Straight Jaw
GFS9L	9" Long Nose with Wire Cutters
GFS10W	10" Curved Jaw with Wire Cutters

**400**  
SERIES



**Gear F Grip-Jaw 11" Filter Plier 45-130mm**  
**GFG11F**

Suitable for Most Popular Cars And Light Commercial Vehicles

**Features**

- Chrome Vanadium Steel Jaws
- Jaw opening 45 - 130mm
- Screw tension adjustment
- Satin finish
- Quick Release action
- Ergonomic Handles for comfort in use
- GearF - Franklin Lifetime Warranty



**Gear F 3 pce Wire Stripper Set**  
**GFW3**

**GFW06:** 6 Graded channels for 10-24 AWG allows for accurate wire stripping quickly

**Features**

- Spring load jaw allows quick and easy Wire cutting
- Crimps insulated and non-insulated terminals
- Serrated Plier Jaw grips to pull and loop wire
- Quick release lock protects blade when not in use

**GFWSA:** Self Adjusting stripper strips wire from 10-24 AWG

**Features**

- Adjustable stop controls the length of stripped wire
- Crimps insulated and non-insulated terminals
- Separate Wire cutter

**GFWSC:** Strips and cuts 10-22 AWG

**Features**

- Cutting edges additionally Induction Hardened for extra Sharpness and Durability
- Serrated Plier Jaw grips to pull and loop wire
- Bolt Cutter cuts bolts to correct length
- Crimps insulated and non-insulated terminals

- 400 Series - Build Your Own Tool Box
- 400mm x 150mm EVA Foam Module
- GearF - Franklin Lifetime Warranty
- Supplied in Industry Approved EVA Foam



Part No.	Description
GFW06	Wire Stripper 6"
GFWSA	Automatic Wire Stripper 8"
GFWSC	Stripper and Crimper 8"

**Gear F 6 pce Diamond Power Grip Screwdriver Set**  
**GFDP6**

- PH1 x 100mm
- PH2 x 100mm
- PH3 x 150mm
- 5 x 100mm
- 6 x 100mm
- 8 x 150mm

**Features**

- Diamond Coated Tip, More Grip Less Slip
- S2 Hexagon Steel Pound Thru Shafts with Metal Caps
- Tri-Lobe Comfort Grip Ergonomic Handle
- High Visibility Size Marked Shafts
- 2 Year Warranty Subject to not being mis-used
- Supplied in industry approved EVA foam
- Additional Franklin Storage Case Available



Part No.	Description
GFDPH1	PH1
GFDPH2	PH2
GFDPH3	PH3
GFDSL5	5mm
GFDSL6	6mm
GFDSL8	8mm
AFBMC3	Case
GFDP7	Complete Set in BMC



**Gear F 14 pce Pro Screwdriver Set**  
**GFS214**

- Slotted : 3.0 x 75, 4.0 x 100, 5.5 x 100 6.5 x 25, 6.5 x 125, 8.0 x 150, 10 x 200 mm
- PH1 x 100, PH2 x 25, PH2 x 100 mm
- PZ1 x 100, PZ2 x 100, PZ3 x 150 mm
- Magnetic Bit Holder Screwdriver

**Features**

- Professional Quality Heavy Duty Screwdrivers
- Ergonomic Comfort Grip handles with Non-Slip Material allows for More Grip
- Hexagon Shanks and Heads on the larger sizes - Enabling increased Torque to be applied when used with a spanner
- High Grade S2 Chrome Vanadium Steel Shaft and Hardened Blade
- Satin Finish and Plated to Prevent Corrosion
- Manufactured to DIN Standards
- GearF - Franklin Lifetime Warranty
- In Blow Mould Storage Case





**Gear F 46 pce Pro Screwdriver Set**  
**GFS246**

- Slotted : 3.0 x 75, 4.0 x 100, 5.5 x 100 6.5 x 25, 6.5 x 125, 8.0 x 150, 10 x 200 mm
- PH1 x 100, PH2 x 25, PH2 x 100 mm
- PZ1 x 100, PZ2 x 100, PZ3 x 150 mm
- Magnetic Bit Holder Screwdriver
- TP500 32 pce Bit Set

**Features**

- Professional Quality Heavy Duty Screwdrivers
- Ergonomic Comfort Grip handles with Non-Slip Material allows for More Grip
- Hexagon Shanks and Heads on the larger sizes - Enabling increased Torque to be applied when used with a spanner
- High Grade S2 Chrome Vanadium Steel Shaft and Hardened Blade
- Satin Finish and Plated to Prevent Corrosion
- Manufactured to DIN Standards
- GearF - Franklin Lifetime Warranty
- In Blow Mould Storage Case



**Gear F 6 pce Phillips & Pozi S2 PRO Screwdriver Set**  
**GFS2P**

PH1x100mm PH2x100mm PH2x200mm PH3x150mm PZ1x100mm PZ2x100mm

**Features**

- Professional Quality Heavy Duty Screwdrivers
- Ergonomic Comfort Grip handles with Non-Slip Material allows for More Grip
- Hexagon Shanks and Heads on the larger sizes - Enabling increased Torque to be applied when used with a spanner
- High Grade S2 Chrome Vanadium Steel Shaft and Hardened Blade
- Satin Finish and Plated to Prevent Corrosion
- Manufactured to DIN Standards
- GearF - Franklin Lifetime Warranty
- 400 Series - Build Your Own Tool Box 400mm x 150mm EVA Foam Module
- Supplied in industry approved EVA foam



Part No.	Description
GFPH1	PH1
GFPH2	PH2
GFPH22	PH2 x 200mm
GFPH3	PH3
GFPZ1	PZ1
GFPZ2	PZ2

**Gear F 6 pce Flat S2 PRO Screwdriver Set**  
**GFS2F**

3x75mm 4x100mm 4x200mm 5.5x125mm 6.5x125mm 8x150mm

**Features**

- Professional Quality Heavy Duty Screwdrivers
- Ergonomic Comfort Grip handles with Non-Slip Material allows for More Grip
- Hexagon Shanks and Heads on the larger sizes - Enabling increased Torque to be applied when used with a spanner
- High Grade S2 Chrome Vanadium Steel Shaft and Hardened Blade
- Satin Finish and Plated to Prevent Corrosion
- Manufactured to DIN Standards
- GearF - Franklin Lifetime Warranty
- 400 Series - Build Your Own Tool Box 400mm x 150mm EVA Foam Module
- Supplied in industry approved EVA foam



Part No.	Description
GFSL3	3mm
GFSL4	4mm
GFSL42	4mm x 200mm
GFSL55	5.5mm
GFSL65	6.5mm
GFSL8	8mm



**Gear F 6 pce Star S2 PRO Screwdriver Set**  
**GFS2T**

TS10x80mm TS15x80mm TS20x100mm TS25x100mm TS27x115mm TS30x115mm

**Features**

- Professional Quality Heavy Duty Screwdrivers
- Ergonomic Comfort Grip handles with Non-Slip Material allows for More Grip
- High Grade S2 Chrome Vanadium Steel Shaft and Hardened Blade
- Satin Finish and Plated to Prevent Corrosion
- Manufactured to DIN Standards
- GearF - Franklin Lifetime Warranty
- 400 Series - Build Your Own Tool Box 400mm x 150mm EVA Foam Module
- Supplied in industry approved EVA foam

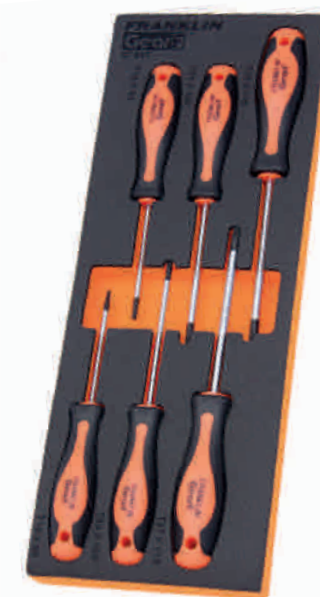

Part No.	Description
GFST10	TS10
GFST15	TS15
GFST20	TS20
GFST25	TS25
GFST27	TS27
GFST30	TS30

**Gear F 6 pce Tamperproof Star S2 PRO Screwdriver GFS2TL**

TS10x250mm TS15x250mm TS20x250mm TS25x250mm TS27x250mm TS30x250mm

**Features**

- Professional Quality Heavy Duty Screwdrivers
- Ergonomic Comfort Grip handles with Non-Slip Material allows for More Grip
- High Grade S2 Chrome Vanadium Steel Shaft and Hardened Blade
- Satin Finish and Plated to Prevent Corrosion
- Manufactured to DIN Standards
- GearF - Franklin Lifetime Warranty
- 400 Series - Build Your Own Tool Box 400mm x 150mm EVA Foam Module



Part No.	Description
GFTS10	10 x250mm
GFTS15	15 x 250mm
GFTS20	20 x250mm
GFTS25	25 x 250mm
GFTS27	27 x 250mm
GFTS30	30 x 250mm



**Gear F 26 pce Multidrive Socket and Mini Ratchet Set 1/4" dr GF026M**

- GFRF14 - 72T, 1/4"dr Flex Head Mini Ratchet with Bit Holder End
- XFLM13 - 13pce Low Profile Multi-Drive sockets 4 4.5 5 5.5 6 7 8 9 10 11 12 13 14 x 17mm
- GFB10M - 10 S2 Steel Bits in Holder - PH1 PH2 PZ1 PZ2 SL4 SL5.5 SL6.5 H4 H5 H6
- Chrome Vanadium Steel Sockets
- GFE75 - 75mm Extension Bar
- TP114 - 1/4" Hexagon Bit Holder x 1/4"dr
- Supplied in Industry Approved EVA Foam
- GearF - Franklin Lifetime Warranty



Part No.	Description
GFB10M	10 pce Bits



**Gear F 32pce Precision Scwdriver Set GF032**

PH000, PH00, PH0, PH1, PZ0, PZ1  
Slot - 1, 1.5, 2, 2.5, 3, 3.5, 4mm  
Hex - 0.7, 0.9, 1.3, 1.5, 2, 2.5, 3, 4mm  
Star - T4, T5, T6, T7, T8, T9, T10, T15, T20

**Features**

- Comfort Grip Handle with extending shaft
- S2 Steel
- 30 x 4mm hexagon bits
- Flexible extension
- Supplied in Industry Approved EVA Foam
- GearF - Franklin Lifetime Warranty



**Gear F 26 pce 6pt Socket and Mini Ratchet Set 1/4" dr GF026H**

- GFRF14 - 72T, 1/4"dr Flex Head Mini Ratchet with Bit Holder End
- XFL13 - 13 pce Low Profile 6 point sockets 4 4.5 5 5.5 6 7 8 9 10 11 12 13 14 x 17mm
- GFB10M - 10 S2 Steel Bits in Holder - PH1 PH2 PZ1 PZ2 SL4 SL5.5 SL6.5 H4 H5 H6
- Chrome Vanadium Steel Sockets
- GFE75 - 75mm Extension Bar
- TP114 - 1/4" Hexagon Bit Holder x 1/4"dr
- Supplied in Industry Approved EVA Foam
- GearF - Franklin Lifetime Warranty



Part No.	Description
GFB10M	10 pce Bits





**Gear F 9pce Ratchet Screwdriver Set  
GFRS9**

- 60T Flex Ratchet Bit Driver Handle With 3 Positions
- Magnetic chuck for rapid tool changes
- Integrated handle storage - 6 S2 Steel bits PH1 PH2 PZ1 PZ2 SL5 SL6.5
- Torque Loading 50Nm (DIN standard 30Nm)
- GFM50 - 50mm extension with magnetic bit holder
- GFM100 - 100mm extension with magnetic bit holder
- GearF - Franklin Lifetime Warranty



**Gear F 59 pce Multidrive Socket and Ratchet Screwdriver Set 1/4"dr  
GF059M**

- GFRS9 - 60T Flex Ratchet Bit Driver Handle With 3 Positions
- Integrated handle storage - 6 S2 Steel bits PH1 PH2 PZ1 PZ2 SL5 SL6.5
- Torque Loading 50Nm (DIN standard 30Nm)
- 60T Ratcheting System with Forward, Reverse and Lock Positions
- XFLM13 - 13pce Low Profile Multi-Drive Socket Set  
4 4.5 5 5.5 6 7 8 9 10 11 12 13 14 x 17mm
- Chrome Vanadium Steel Sockets
- GFB9S - 9pce holder with S2 Steel Star T8 T9 T10 T15 T20 T25 T27 T30 T40
- GFB9TS - 9pce holder with S2 Steel Tamper Star  
TS8 TS9 TS10 TS15 TS20 TS25 TS27 TS30 TS40
- GFB9PP - 9pce holder with S2 Steel  
PH0 PH1 PH2 PH3 PZ0 PZ1 PZ2 PZ3  
+ 1/4" male hex to 1/4" male square bit complete with ball and Spring
- GFB9SH - 9pce holder with S2 Steel  
SL6.5 SL5.5 SL4 SL3 3mm Hex 4mm Hex 5mm Hex 6mm Hex 7mm Hex
- TP114 - 1/4" Hexagon Bit Holder x 1/4"sq dr
- GFM50 - 50mm extension with magnetic bit holder
- GFM100 - 100mm extension with magnetic bit holder
- Supplied in Industry Approved EVA Foam
- GearF - Franklin Lifetime Warranty



**Gear F 59pce 6pt Socket and Ratchet Screwdriver Set 1/4" dr  
GF059H**

- GFRS9 - 60T Flex Ratchet Bit Driver Handle With 3 Positions
- Integrated handle storage - 6 S2 Steel bits PH1 PH2 PZ1 PZ2 SL5 SL6.5
- Torque Loading 50Nm (DIN standard 30Nm)
- 60T Ratcheting System with Forward, Reverse and Lock Positions
- XFL13 - 13pce Low Profile 6 point Socket Set  
4 4.5 5 5.5 6 7 8 9 10 11 12 13 14 x 17mm
- Chrome Vanadium Steel Sockets
- GFB9S - 9pce holder with S2 Steel Star  
T8 T9 T10 T15 T20 T25 T27 T30 T40
- GFB9TS - 9pce holder with S2 Steel Tamper Star  
TS8 TS9 TS10 TS15 TS20 TS25 TS27 TS30 TS40
- GFB9PP - 9pce holder with S2 Steel  
PH0 PH1 PH2 PH3 PZ0 PZ1 PZ2 PZ3  
+ 1/4" male hex to 1/4" male square bit complete with ball and Spring
- GFB9SH - 9pce holder with S2 Steel  
SL6.5 SL5.5 SL4 SL3 3mm Hex 4mm Hex 5mm Hex 6mm Hex 7mm Hex
- TP114 - 1/4" Hexagon Bit Holder x 1/4"sq dr
- GFM50 - 50mm extension with magnetic bit holder
- GFM100 - 100mm extension with magnetic bit holder
- Supplied in Industry Approved EVA Foam
- GearF - Franklin Lifetime Warranty



Sign up online at <https://www.franklin-tools.co.uk/register>

Why become a Franklin Tool account holder?

- You will be able to log into your account to check product availability and place orders 24 hours a day
- See our latest promotions and distributor exclusive offers
- Take advantage of our "Quick Order" facility by entering your part number and the quantity you require
- For your regular stock items, select products from previous orders using our "Cherry Pick" facility

## Gear F 106 pce Master Screwdriver and Mini Ratchet Set 1/4"dr

### GFS106

- GFRS9 - 60T Flex Ratchet Bit Driver Handle With 3 Positions
- Integrated handle storage - 6 S2 Steel bits PH1 PH2 PZ1 PZ2 SL5 SL6.5
- Torque Loading 50Nm (DIN standard 30Nm)
- 60T Ratcheting System with Forward, Reverse and Lock Positions
- XFL13 - 13pce Low Profile 6 point Hexagon Socket Set  
4 4.5 5 5.5 6 7 8 9 10 11 12 13 14 x 17mm
- XFLM13 - 13pce Low Profile Multi-Drive Socket Set  
4 4.5 5 5.5 6 7 8 9 10 11 12 13 14 x 17mm
- Chrome Vanadium Steel Sockets
- GFB9S - 9pce holder with S2 Steel Star T8 T9 T10 T15 T20 T25 T27 T30 T40
- GFB9TS - 9pce holder with S2 Steel Tamper Star TS8 TS9 TS10 TS15 TS20 TS25 TS27 TS30 TS40
- GFB9PP - 9pce holder with S2 Steel PH0 PH1 PH2 PH3 PZ0 PZ1 PZ2 PZ3 and 1/4" male hex to 1/4" male square bit complete with ball and Spring
- GFB9SH - 9pce holder with S2 Steel SL3 SL4 SL5.5 SL6.5 Hex 3 4 5 6 7mm
- TP114 - 1/4" Hexagon Bit Holder x 1/4"dr
- GFM50 - 50mm extension with magnetic bit holder
- GFM100 - 100mm extension with magnetic bit holder
- GF032 - 32pce Precision Screwdriver Set
- S2 Steel Bits - PZ0, PZ1, PH000, PH00, PH0, PH1
- Slot - 1, 1.5, 2, 2.5, 3, 3.5, 4mm
- Hex - 0.7, 0.9, 1.3, 1.5, 2, 2.5, 3, 4mm
- Star - T4, T5, T6, T7, T8, T9, T10, T15, T20
- GFRF14 - 72T 1/4"dr Flex Head Mini Ratchet with Bit Holder End
- GFE75 - 75mm Extension Bar
- Supplied in Industry Approved EVA Foam
- GearF - Franklin Lifetime Warranty



Part No.	Description
TP114	1/4" Hex 1/4" dr
GFB9S	9pce Bit Holder with Star
GFB9TS	9pce Bit Holder with Tamper
GFB9SH	9pce Bit Holder with Slot and Hex
GFM50	50mm Magnetic Bit Holder
GFM100	100mm Magnetic Bit Holder
GFE75	75mm Extension Bar 1/4"dr
GFRF14	72T Flexi Mini Ratchet 1/4"dr
GFB9PP	9pce Bit Holder with Pozi, Ph and 1/4" Male Sq
GFRF14	72T Flexi Mini Ratchet 1/4"dr
GFS107	Complete Set in BMC





# AF Series - D

## Contents

Spanners	D2
Chisels	D6
Screwdrivers	D10
Automotive	D13

**FF Franklin & Co Ltd**

Platt Street

Sheffield

S3 8BQ

England

**Telephone**

0114 272 1429

**Facsimile**

0114 272 7030

**Email**

orders@franklin-tools.co.uk

**Tools in EVA Modules**  
**2020**

**www.franklin-tools.co.uk**



**Franklin 8 pce 12 pt Ring Spanner Set**  
**AF2701**

6 x 7, 8 x 9, 10 x 11, 12 x 13, 14 x 15 16 x 17, 18 x 19, 20 x 22 mm

**Features**

- Chrome Vanadium Steel
- Mirror Finish
- 400 Series - Build Your Own Tool Box  
400mm x 200mm EVA Foam Module
- Supplied in industry approved EVA foam



Part No.	Description
271067	6 x 7mm
271089	8 x 9mm
271111	10 x 11mm
271123	12 x 13mm
271145	14 x 15mm
271167	16 x 17mm
271189	18 x 19mm
271202	20 x 22mm



**Franklin 4 pce Star Ring Spanner Set**  
**AF2704**

E6 x E8, E10 x E12, E14 x E18, E20 x E24

**Features**

- Chrome Vanadium Steel
- Mirror Finish
- Supplied in industry approved EVA foam



Part No.	Description
274068	E6 x E8
274102	E10 x E12
274148	E14 x E18
274204	E20 x E24



**Franklin 10 pce 12 pt Stubby Spanner Set**  
**AF2702**

10 11 12 13 14 15 16 17 18 19mm

**Features**

- Chrome Vanadium Steel
- Mirror Finish
- Supplied in industry approved EVA foam



Part No.	Description
270210	10mm
270211	11mm
270212	12mm
270213	13mm
270214	14mm
270215	15mm
270216	16mm
270217	17mm
270218	18mm
270219	19mm



**Franklin 5 pce 12 pt Mini Ring Spanner Set**  
**AF2705**

10 x 11 12 x 13 14 x 15 16 x 17 18 x 19 mm

**Features**

- Chrome Vanadium Steel
- Mirror Finish
- Supplied in industry approved EVA foam



Part No.	Description
275101	10 x 11mm
275123	12 x 13mm
275145	14 x 15mm
275167	16 x 17mm
275189	18 x 19mm





**Franklin 6 pce Flare Nut Wrench Set**  
**AF2706**

8 x 9 10 x 11 12 x 13 14 x 15 16 x 17 18 x 19 mm

**Features**

- Chrome Vanadium Steel
- Satin Finish
- Supplied in industry approved EVA foam



Part No.	Description
276089	8 x 9mm
276101	10 x 11mm
276123	12 x 13mm
276145	14 x 15mm
276167	16 x 17mm
276189	18 x 19mm



**Franklin 8 pce Tubular Box Spanner and T-Bar Set**  
**AF2708**

6 x 7 x 113mm  
8 x 9 x 115mm  
10 x 11 x 125mm  
12 x 13 x 138mm  
14 x 15 x 138mm  
16 x 17 x 147mm  
18 x 19 x 164mm  
20 x 22 x 176mm

**Features**

- For use on Parking Brake Cable Adjusters on VAG, Vauxhall/Opel, BMW and Ford
- Ideal for heavily recessed fixings - Bumpers, Rear Lamps, Door Hinge Fittings etc.
- Slimline and Long Reach
- Stepped T-Bar
- 400 Series - Build Your Own Tool Box  
400mm x 150mm EVA Foam Module
- Supplied in Industry Approved EVA Foam



**400**  
SERIES



**Franklin 4 pce Flexi Flarenut Wrench Set**  
**AF2714**

8 x 11 mm - 10 x 12 mm - 13 x 17 mm - 14 x 19 mm

**Features**

- For Use On Brake Pipe Unions and Other General Applications
- Chrome Vanadium Steel
- Satin Finish
- Swivel Head Assists With Reaching Fasteners Where Access is Obstructed
- Supplied in Industry Approved EVA Foam



**Franklin 4 pce Adjustable Wrench Set 6 8 10 12"**  
**AF2709**

• 6" x 18mm Jaw  
• 8" x 26mm Jaw  
• 10" x 30mm Jaw  
• 12" x 35mm Jaw

**Features**

- Drop forged carbon steel hardened and tempered
- 400 Series - Build Your Own Tool Box  
400mm x 200mm EVA Foam Module
- Supplied in industry approved EVA foam



**400**  
SERIES

Part No.	Description
9506	6"
9508	8"
9510	10"
9512	12"
9515	15" Additional Size



**Franklin 3 pce Scraper Set**  
**AF1703**

- Hardened Stainless Steel Blades
- 30 mm Flat
- 30 mm 20 Degree Angled
- 50 mm Flat
- Supplied in industry approved EVA foam



Part No.	Description
170330	30mm
170332	30mm (20 degree)
170350	50mm



**Franklin 4 pce Chisel Set**  
**AF1724**

- Heavy Duty Chisel Set
- 1 x 13 x 150mm Cold Chisel
  - 1 x 16 x 200mm Cold Chisel
  - 1 x 20 x 250mm Cold Chisel
  - 1 x 25 x 250mm Cold Chisel

**Features**

- Hardened and Tempered Steel
- Induction Hardened Cutting Edges
- Chamfered Struck End
- Supplied in Industry Approved EVA Foam



**Franklin 13 pce Chisel and Punch Set**  
**AF1713**

**Cold Chisel**

- 3/8" (10mm) x 5/16" x 5-1/4" (135mm)
- 1/2" (12mm) x 3/8" x 6" (150mm)
- 3/4" (19mm) x 5/8" x 7" (180mm)
- 7/8" (22mm) x 3/4" x 7-1/2" (190mm)

**Crosscut Chisel**

- 1/4" (6mm) x 3/8" x 6" (150mm)

**Pin Punch**

- 1/8" (3mm) x 5/16" x 5" (125mm)
- 5/32" (4mm) x 3/8" x 5-1/4" (135mm)
- 3/16" (5mm) x 3/8" x 6" (150mm)
- 1/4" (6mm) x 3/8" x 7" (180mm)

**Centre Punch**

- 5/32" (4mm) x 3/8" x 5" (125mm)

**Taper Punch**

- 1/8" (3mm) x 5/16" x 4-1/2" (115mm)
- 5/32" (4mm) x 3/8" x 5" (125mm)
- 3/16" (5mm) x 3/8" x 5" (125mm)

**Features**

- Chrome Vanadium Steel
- Black finish
- 400 Series - Build Your Own Tool Box
- 400mm x 200mm EVA Foam Module
- Supplied in Industry Approved EVA Foam



Part No.	Description
171310	10mm (3/8") Cold Chisel
171312	12mm (1/2") Cold Chisel
171319	19mm (3/4") Cold Chisel
171322	22mm (7/8") Cold Chisel
1713CC	6mm (1/4") Crosscut Chisel
17133P	3mm (1/8") Pin Punch
17134P	4mm (5/32") Pin Punch
17135P	5mm (3/16") Pin Punch
17136P	6mm (1/4") Pin Punch
17134C	4mm (5/32") Centre Punch
17133T	3mm (1/8") Taper Punch
17134T	4mm (5/32") Taper Punch
17135T	5mm (3/16") Taper Punch

**400**  
SERIES



**Franklin 4 pce Long Cold Chisel Set**  
**AF1704**

- 12 16 19 22mm x 300

**Features**

- High Grade Chrome Molybdenum Steel
- Mirror Finish
- Plated to Prevent Corrosion
- Ergonomic Handles for Comfort in Use
- Individually Size Marked
- 400 Series - Build Your Own Tool Box
- 400mm x 150mm EVA Foam Module
- Supplied in Industry Approved EVA Foam



Part No.	Description
170412	12mm
170416	16mm
170419	19mm
170422	22mm



**400**  
SERIES





**Franklin 10pce Punch and Chisel Set**  
**AF1710**

- Pin Punch: 3 4 5 6mm
- Taper Punch: 4 5 6mm
- Centre Punch: 2.5mm
- Cold Chisel: 12 16mm

**Features**

- High Grade Chrome Molybdenum Steel
- Mirror Finish
- Plated to Prevent Corrosion
- Ergonomic Handles for Comfort in Use
- Individually Size Marked
- 400 Series - Build Your Own Tool Box  
400mm x 200mm EVA Foam Module
- Supplied in Industry Approved EVA Foam



Part No.	Description
171012	12mm Cold Chisel
171016	16mm Cold Chisel
17103P	3mm Pin Punch
17104P	4mm Pin Punch
17104T	4mm Taper Punch
17105P	5mm Pin Punch
17105T	5mm Taper Punch
17106P	6mm Pin Punch
17106T	6mm Taper Punch
1710CP	2.5mm Centre Punch



**400**  
SERIES

**Franklin 4pce Long Pin Punch Set**  
**AF1714**

10 x 230 12 x 250 14 x 290 16 x 310mm

**Features**

- High Grade Chrome Molybdenum Steel
- Mirror Finish
- Plated to Prevent Corrosion
- Ergonomic Handles for Comfort in Use
- Individually Size Marked
- 400 Series - Build Your Own Tool Box 400mm x 150mm EVA Foam Module
- Supplied in Industry Approved EVA Foam



Part No.	Description
171410	10 x 230mm
171412	12 x 250mm
171414	14 x 290mm
171416	16 x 310mm



**400**  
SERIES

**Franklin 18 pce Star and Hexagon Angle Wrench Set**  
**AF1718**

**Contents**

- TP980 - Long Star x Short Star
- T10 T15 T20 T25 T27 T30 T40 T45 T50
- TP990 - Long Ball End Hexagon x Short Hexagon
- 1.5 2.0 2.5 3.0 4.0 5.0 6.0 8.0 10.0 mm

**Features**

- S2 Steel
- Extra Long Colour Coded for easy size selection
- Supplied in industry approved EVA foam



**Franklin 6 pce Soft Grip Handled File Set 8"**  
**AF1720**

200mm (8") Hand Files with Soft Grip Handles

- 8" Hand Bastard
- 8" Hand Second Cut
- 8" Square Second Cut
- 8" Round Second Cut
- 8" Flat Second Cut
- 8" Half Round Second Cut
- 400 Series - Build Your Own Tool Box  
400mm x 200mm EVA Foam Module
- Supplied in industry approved EVA foam

Part No.	Description
172HR2	8" Half Round Second Cut
172S2	8" Square Second Cut
172R2	8" Round Second Cut
172HB	8" Hand Bastard
172H2	8" Hand Second Cut
172F2	8" Flat Second Cut



**400**  
SERIES



**Franklin 8 pce Long Star T Handle Set**  
**AF1708**

Long Star x Short Tamperproof Star

- T10 x 75mm
- T15 x 75mm
- T20 x 100mm
- T25 x 100mm
- T30 x 150mm
- T40 x 150mm
- T45 x 200mm
- T50 x 200mm

**Features**

- Chrome Vanadium Steel
- Ergonomic Handles for comfort in use
- Roll marked on shaft and printed on handle for easy identification
- **400 Series** - Build Your Own Tool Box  
400mm x 250mm EVA Foam Module
- Supplied in Industry Approved EVA Foam



Part No.	Description
170810	T10 x 75mm
170815	T15 x 75mm
170820	T20 x 100mm
170825	T25 x 100mm
170830	T30 x 150mm
170840	T40 x 150mm
170845	T45 x 200mm
170850	T50 x 200mm



**Franklin 9 pce S2 Screwdriver Set**  
**A6999**

- 3.2 x 75mm
- 5.0 x 75mm
- 6.0 x 100mm
- 8.0 x 150mm
- 9.5 x 200mm
- PZ0 x 75mm
- PZ1 x 75mm
- PZ2 x 100mm
- PZ3 x 150mm

**Features**

- Premier Quality Screwdriver Set
- S2 Steel Full Length Blades
- Extra Hard Magnetic Tips
- Ergonomic Soft Grip Handles
- Hexagon Shanks for use with a spanner when more torque is required
- **400 Series** - Build Your Own Tool Box  
400mm x 150mm EVA Foam Module
- Supplied in Industry Approved EVA Foam



Part No.	Description
6920	PZ0 x 75
6921	PZ1 x 75
6922	PZ2 x 100
6923	PZ3 x 150
6932	3.2 x 75
6950	5.0 x 75
6960	6.0 x 100
6980	8.0 x 150
6995	9.5 x 200



**Franklin 8 pce Long Hexagon T Handle Set**  
**AF1709**

Long Ball End Hexagon x Short Hexagon

- 2.0 x 75mm
- 2.5 x 75mm
- 3.0 x 100mm
- 4.0 x 100mm
- 5.0 x 150mm
- 6.0 x 150mm
- 8.0 x 200mm
- 10.0 x 200mm

**Features**

- Chrome Vanadium Steel
- Ergonomic Handles for comfort in use
- Roll marked on shaft and printed on handle for easy identification
- **400 Series** - Build Your Own Tool Box  
400mm x 250mm EVA Foam Module
- Supplied in Industry Approved EVA Foam

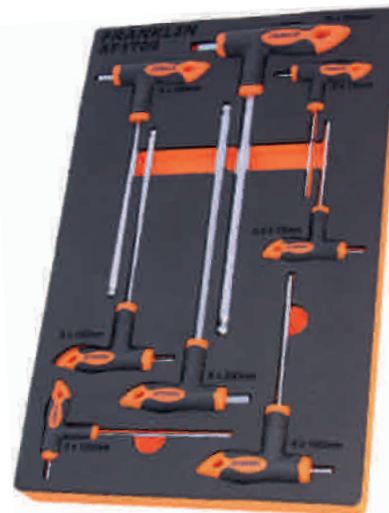

Part No.	Description
170920	2 x 75mm
170925	2.5 x 75mm
170930	3 x 100mm
170940	4 x 100mm
170950	5 x 150mm
170960	6 x 150mm
170980	8 x 200mm
170910	10 x 200mm



**Franklin 3 pce Flexible Driver Set**  
**AF2803**

- 1/4" Square Drive
- 3/8" Square Drive
- 1/4" Hexagon Drive with Magnetic Hex

**Features**

- Ergonomic Soft Grip Handles
- Flexible Rubber Blades
- **400 Series** - Build Your Own Tool Box  
400mm x 150mm EVA Foam Module
- Supplied in industry approved EVA foam



Part No.	Description
280338	Male Flex Driver 3/8"dr
280314	Male Flex Driver 1/4"dr
280306	Mag Bit Holder Flex Driver 1/4"dr





**Franklin 5 pce Flexible Nut Spinner Set**  
**AF2805**

5 6 7 8 10mm

**Features**

- Ergonomic Soft Grip Handles
- Flexible Rubber Blades
- 400 Series - Build Your Own Tool Box  
400mm x 150mm EVA Foam Module
- Supplied in industry approved EVA foam



**400**  
SERIES 6PT

**FRANKLIN**  
Professional Quality Tools

Part No.	Description
280505	5mm
280506	6mm
280507	7mm
280508	8mm
280510	10mm

**Franklin 6 pce Measuring and Cutting Set**  
**AF2906**

- Digital Vernier 0-150mm
- PCL Digital Tyre Depth Gauge
- 5M / 16 ft Measuring Tape
- 6" / 150mm Stainless Steel Rule
- 32 Blade Metric/Imperial Feeler Gauge
- Auto Load Utility Knife

**Features**

- 400 Series - Build Your Own Tool Box  
400mm x 200mm EVA Foam Module
- Supplied in Industry Approved EVA Foam



**400**  
SERIES

**FRANKLIN**  
Professional Quality Tools

Part No.	Description
137	Feeler Gauge
1620	Utility Knife
AT842	Digital Vernier
TA855	5M/16ft Measuring Tape
ATDG1	Digital Tyre Depth Gauge

**Franklin 5 pce Inspection Set**  
**AF2905**

- Round 2 LED Inspection Mirror
- Rectangle 2 LED Inspection Mirror
- Magnetic Pick Up Tool
- Super Power Magnetic Pick Up Tool
- 6 LED Torch with Telescopic Magnet

**Features**

- 400 Series - Build Your Own Tool Box  
400mm x 200mm EVA Foam Module
- Supplied in Industry Approved EVA Foam



**400**  
SERIES

**FRANKLIN**  
Professional Quality Tools

Part No.	Description
FL61	Torch and Telescopic Magnet
TA669	Powerful Magnetic Pick Up Tool
TA670	Magnetic Pick Up Tool
TA6770	Round LED Inspection Mirror
TA6771	Rectangular LED Inspection Mirror

**Franklin 3/16" SAE Brake Flaring Set**  
**AF2020**

- AF2003 - Brake Flaring Tool - Hand Held
- 3/16" SAE - Designed for use on the vehicle to produce single and double SAE flares.
- AT210 - Pipe Bender
- Compact tool for use in confined spaces. Not suitable for use on steel pipe. 3mm / 4mm / 6mm / 3/16" / 1/4"
- TA764 - Mini Tube Cutter
- Tungsten steel cutter, twin rollers. Capacity 1/8" - 5/8" (3-16mm) o.d.
- TA762 - Brake Pipe Aid Pliers
- For 3/16" and 1/4" dia. Brake and fuel lines. Use to align bend and adjust brake and fuel lines - shaped jaws bend tube without distortion. forged steel with heavy duty grips

**Features**

- Tough Impact Resistant Carry Case Available
- Supplied in industry approved EVA foam



**FRANKLIN**  
Professional Quality Tools

Part No.	Description
AF2021	Complete Set in BMC

**Franklin 3 pce Hose Clamp Set**  
**AF2023**

Ideal for use on most flexible hose lines.  
Light weight material construction in high visibility colour for easy location.

**Features**

- Designed for Single handed use
- Suitable for most flexible hoses
- **400 Series** - Build Your Own Tool Box 400mm x 150mm
- Supplied in industry approved EVA foam



Part No.	Description
TA767	Small
TA768	Medium
TA769	Large

**400**  
SERIES



**Franklin 4 pce Int/Ext Circlip Plier Set**  
**AF2070**

- 175mm Internal & External Sraight
- 175mm Internal & External Angled

**Features**

- 2mm Precision Ground Tips
- Spring Loaded Handle Assist
- Ergonomic Comfort Grips
- Supplied in Industry Approved EVA Foam



**Franklin 5 pce Oxygen Sensor Set**  
**AF2035**

Suitable For Oxygen Sensors found on most modern vehicles  
Slots enable socket and wrenches to be fitted over wiring harness

**Features**

- M12 x 1.25mm - M18 x 1.50mm Thread Chasers For cleaning lambda sensor threads
- 22mm Offset Wrench x 30mm 3/8"dr
- 22mm Offset Wrench x 50mm 1/2"dr
- 22mm Socket (with slot) x 78mm 3/8"dr
- Supplied in Industry Approved EVA Foam



**Franklin 2 pce Oil Filter Plier Set**  
**AF2032**

Designed For Releasing Stubborn Filters Where Access Is Restricted  
TA374 - 45 - 89mm diameter - 250 mm  
TA375 - 54 - 108mm diameter - 300 mm

**Features**

- Heavy Duty Drop Forged Serrated Jaws
- Extra Long Handles
- Dipped Handles For Comfort Whilst in use
- Supplied in Industry Approved EVA Foam



**400**  
SERIES

**Franklin 5 pce Hub Cleaning Set**  
**AF2015**

For the removal of rust from the brakes, rotor and hub

**Features**

- 1 x 1/2" Drive Socket
- 4 x 50mm Threaded Poly Discs
- Anti-clogging construction
- Removes rust and corrosion quickly
- Quick disc changes
- Can be run on impact guns (either Electrical or Pneumatic)



**1/2"**



Part No.	Description
AF2014	4 x 50mm Replacement Threaded Poly Discs



**Franklin 5 pce Brake Caliper Wind Back Set**  
**AF2025**

- AT8702 – Adjustable 2 Pin Adaptor
  - AT8703 - Adjustable 3 Pin Adaptor
  - 18850 – Right Hand Wind Back Assembly
  - 18860 – Left Hand Wind Back Assembly
  - 1870P – Reaction Plate
- Features**
- Tough Impact Resistant Carry Case Available
  - Supplied in Industry Approved EVA Foam



Part No.	Description
AF2026	Complete Set in BMC



**Franklin 7 pce Hook and Pick Set**  
**AF2027**

- 5" Cotter Pin Puller
  - 5" Straight Pick
  - 4 1/2" Awl
  - 3 1/8" Straight pick
  - 3 1/8" Hook pick
  - 3 1/8" 90 Degrees pick
  - 3 1/8" O Ring pick.
- Features**
- Chrome Vanadium Steel
  - Ergonomic Handles
  - 400 Series - Build Your Own Tool Box
  - 400mm x 150mm EVA Foam Module
  - Supplied in industry approved EVA foam



Part No.	Description
20273H	Hook
20273S	3 1/8" Straight
20274A	Awl
20275S	Straight
202739	90 Degree
202730	O Ring
20275C	Cotter Pin



**400**  
SERIES

**Franklin 4 pce Door Panel Remover Set**  
**AF2024**

- Door Upholstery Panel Remover
  - Curved Blade Panel Remover
  - Small V Panel Remover
  - Gasket Scraper
- Features**
- Chrome Vanadium Steel
  - Ergonomic Handles
  - 400 Series - Build Your Own Tool Box
  - 400mm x 150mm EVA Foam Module
  - Supplied in industry approved EVA foam



Part No.	Description
2024DP	Door Upholstery
2024CP	Curved Blade
2024VP	Small V
2024GS	Gasket Scraper



**400**  
SERIES



**Franklin 4 pce Large Hook and Pick Set**  
**AF2029**

- Combination Pick 15"
  - 90 Degree Pick 15"
  - Straight Pick 15"
  - Hook Pick 15"
- Features**
- Chrome Vanadium Steel
  - Ergonomic Handles
  - 400 Series - Build Your Own Tool Box
  - 400mm x 150mm EVA Foam Module
  - Supplied in industry approved EVA foam



Part No.	Description
2029CP	Combination
2029SP	Straight
2029HP	Hook
202990	90 Degree



**400**  
SERIES



## Franklin 4 pce Stud Extractor Set 1/2" dr

**AF2124**

6 8 10 12mm

### Features

- Chrome Vanadium Steel
- Professional quality concentric roller action
- Roll Marked for easy identification
- Supplied in industry approved EVA foam

Part No.	Description
TA226	6mm
TA228	8mm
TA2210	10mm
TA2212	12mm



1/2"

**FRANKLIN**  
Professional Quality Tools

## Franklin Impact Wheel Nut Removal Set

**AFT26**

### Contents

- AFT001 - Outer Shroud
- AFT002 - Inner Shroud
- AFT003 - Blade A
- AFT004 - Blade B
- AFT005 - Mandrel A
- AFT006 - Mandrel B
- AFT007 - Coiled Spring
- AFT008 - Spring Ring (1 spare)
- AFT009 - Main Body
- AFT010 - Centre Punch
- AFT011 - Rubber O Ring
- AFT014 - Disposable Blade C
- AFT015 - Hand Protection Ring
- AFT15 - Impact Driver
- FT224 - 24mm Impact Socket 1/2" dr

### Features

- As used by leading recovery operations
- Allows removal of rounded wheel nuts and most types of locking wheel nuts in an emergency
- Made using S1 steel for the A and B blades
- C blade also included For use on hardened McGard nuts
- Full Instruction Manual Provided
- Supplied in a tough Impact Resistant Carry Case and industry approved EVA foam

Part No.	Description
AFT25	Set without Impact Driver
AFT020	Jaguar Models Additional Part
AFT030	Range Rover Models Additional Part
AFT24	Blade D and Short Outer Shroud for Ford / New Volvo (Additional Part Available)



**FRANKLIN**  
Professional Quality Tools



# Socketry - E

## Contents

Impact Sockets	E2
Sockets on Rails	E9
Bit Sockets	E13
1" dr	E14
Socket Bit Sets	E15
Specialised Sockets	E17
Accessories	E19
Norbar Torque Wrenches	E22
Franklin Torque Wrenches	E25



## XF Socketry

Supplied in industry approved EVA foam



See Section **B**

# 2020

[www.franklin-tools.co.uk](http://www.franklin-tools.co.uk)



## XF Socketry

Supplied in industry approved EVA foam



See Section B

### Franklin 15 pce 6 pt Impact Socket Set 3/8" dr TA8015

8 9 10 11 12 13 14 15 16 17 18 19 20 21 22 mm

**Features**

- High Grade Chrome Vanadium Steel
- 6 Point Surface Drive
- Black Electro Coated Finish
- Manufactured to ANSI Standards
- Clear Roll Marked Size for Easy Identification
- Tough Impact-resistant Carry Case
- Size Organised Storage Aids Tool Selection

Part No.	Description
FT308	8mm
FT309	9mm
FT310	10mm
FT311	11mm
FT312	12mm
FT313	13mm
FT314	14mm
FT315	15mm
FT316	16mm
FT317	17mm
FT318	18mm
FT319	19mm
FT321	21mm
FT322	22mm



### Franklin 16 pce 6 pt Deep Impact Socket Set 3/8" dr TA8016

8 9 10 11 12 13 14 15 16 17 18 19 21 22 23 24mm

**Features**

- High Grade Chrome Vanadium Steel
- 6 Point Surface Drive
- Black Electro Coated Finish
- Manufactured to ANSI Standards
- Clear Roll Marked Size for Easy Identification
- Tough Impact-resistant Carry Case
- Size Organised Storage Aids Tool Selection



Part No.	Description
FT808	8mm
FT809	9mm
FT810	10mm
FT811	11mm
FT812	12mm
FT813	13mm
FT814	14mm
FT815	15mm
FT816	16mm
FT817	17mm
FT818	18mm
FT819	19mm
FT821	21mm
FT822	22mm
FT823	23mm
FT824	24mm

### Franklin 16 pce 6 pt Impact Socket Set 1/2" dr TA804

10 11 12 13 14 15 16 17 18 19 21 22 24 27 30 32mm

**Features**

- High Grade Chrome Vanadium Steel
- 6 Point Surface Drive
- Black Electro Coated Finish
- Manufactured to ANSI Standards
- Clear Roll Marked Size for Easy Identification
- Tough Impact Resistant Carry Case
- Size Organised Storage Aids Tool Selection

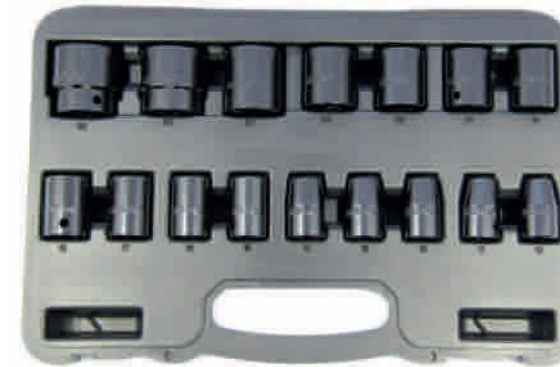

Part No.	Description
FT208	8mm Additional Size
FT209	9mm Additional Size
FT210	10mm
FT211	11mm
FT212	12mm
FT213	13mm
FT214	14mm
FT215	15mm
FT216	16mm
FT217	17mm
FT218	18mm
FT219	19mm
FT221	21mm
FT222	22mm
FT224	24mm
FT227	27mm
FT230	30mm
FT232	32mm



**Franklin 16 pce 6 pt Deep Impact Socket Set 1/2" dr  
TA801**

10 11 12 13 14 15 16 17 18 19 21 22 24 27 30 32mm

**Features**

- High Grade Chrome Vanadium Steel
- 6 Point Surface Drive
- Black Electro Coated Finish
- Manufactured to ANSI Standards
- Clear Roll Marked Size for Easy Identification
- Tough Impact Resistant Carry Case
- Size Organised Storage Aids Tool Selection



Part No.	Description
FT710	10mm
FT711	11mm
FT712	12mm
FT713	13mm
FT714	14mm
FT715	15mm
FT716	16mm
FT717	17mm
FT718	18mm
FT719	19mm
FT721	21mm
FT722	22mm
FT724	24mm
FT726	26mm Additional Size
FT727	27mm
FT730	30mm
FT732	32mm



**Franklin 16 pce 12 pt Deep Impact Sockets 1/2" dr  
TA803**

10 11 12 13 14 15 16 17 18 19 21 22 24 27 30 32mm

**Features**

- High Grade Chrome Vanadium Steel
- 12 Point Surface Drive
- Black Electro Coated Finish
- Manufactured to ANSI Standards
- Clear Roll Marked Size for Easy Identification
- Tough Impact Resistant Carry Case
- Size Organised Storage Aids Tool Selection



Part No.	Description
XB710	10mm
XB711	11mm
XB712	12mm
XB713	13mm
XB714	14mm
XB715	15mm
XB716	16mm
XB717	17mm
XB718	18mm
XB719	19mm
XB721	21mm
XB722	22mm
XB724	24mm
XB727	27mm
XB730	30mm
XB732	32mm



**Franklin 7 pce 6 pt Deep Impact Socket Set 1/2" dr  
TA8017**

33 34 35 36 38 40 41 x 80mm

**Features**

- High Grade Chrome Vanadium Steel
- 6 Point Surface Drive
- Black Electro Coated Finish
- Manufactured to ANSI Standards
- Clear Roll Marked Size for Easy Identification
- Tough Impact-resistant Carry Case
- Size Organised Storage Aids Tool Selection



Part No.	Description
FT733	33mm
FT734	34mm
FT735	35mm
FT736	36mm
FT738	38mm
FT740	40mm
FT741	41mm



**Franklin 8 pce 12 pt Impact Hub Nut Deep Thinwall Socket Set 1/2" dr  
AT818**

24 27 30 32 33 34 35 36 x 78mm

**Features**

- Chrome Molybdenum Steel
- 12 Point Surface Drive
- Black Phosphate Finish
- Deep Impact Sockets
- Deep Bi-Hexagon
- Thin Wall for Improved Access
- Laser Etched for Easy Identification
- Tough Impact-resistant Carry Case
- Size Organised Storage Aids Tool Selection



Part No.	Description
FT624	24mm
FT627	27mm
FT630	30mm
FT632	32mm
FT633	33mm
FT634	34mm
FT635	35mm
FT636	36mm
FT641	41mm Additional size



**Franklin 7 pce Deep Impact External Star Socket Set 1/2" dr**  
**SE870**

E12 E14 E16 E18 E20 E22 E24 x 78mm

**Features**

- High Grade Chrome Vanadium Steel
- Black Electro Coated Finish
- Manufactured to ANSI Standards
- Clear Roll Marked Size for Easy Identification
- Tough Impact-resistant Carry Case
- Size Organised Storage Aids Tool Selection



1/2"



**Franklin 17 pce 6 pt Impact Socket Set 3/4" dr**  
**TA809**

19 21 22 24 27 30 32 33 34 35 36 38 40 41 46 50 55 mm

**Features**

- Chrome Molybdenum Steel
- Black Phosphate Finish
- Laser Etched for Easy Identification
- Tough Impact-resistant Carry Case
- Size Organised Storage Aids Tool Selection



3/4"



Part No.	Description
80919	19mm
80921	21mm
80922	22mm
80924	24mm
80927	27mm
80930	30mm
80932	32mm
80933	33mm
80934	34mm
80935	35mm
80936	36mm
80938	38mm
80940	40mm
80941	41mm
80946	46mm
80950	50mm
80955	55mm

**Franklin 4 pce Impact Spline Bit Set 1/2" dr**  
**TA814**

- M12 - VW Touran Rear Hubs
- M14 - VW LT / Transporter Ball Joints
- M16 (Tamperproof) - VW Sharan Rear Hubs
- M18 (Tamperproof) - VW Golf Rear Hubs
- 1/2 dr x 78mm - Suitable for general use

**Features**

- High Grade Chrome Molybdenum Steel
- Impact Quality Black Phosphate Finish
- Manufactured to DIN Standards
- Tough Impact Resistant Carry Case
- Laser etched size markings (for easy identification)

Part No.	Description
XFIX4	4 pce Set in EVA
81412	Spline M12
81414	Spline M14
81416	Tamper Spline M16
81418	Tamper Spline M18



1/2"



**Franklin 7 pce 6 pt Deep Impact Socket Set 3/4" dr**  
**TA807**

24 27 30 32 33 36 38mm

**Features**

- Chrome Molybdenum Steel
- 6 Point Surface Drive
- Black Phosphate Finish
- Laser Etched for Easy Identification
- Tough Impact-resistant Carry Case
- Size Organised Storage Aids Tool Selection



3/4"



Part No.	Description
TA819	19mm Additional size
TA821	21mm Additional size
TA824	24mm
TA826	26mm Additional size
TA827	27mm
TA828	28mm Additional size
TA830	30mm
TA832	32mm
TA833	33mm
TA836	36mm
TA838	38mm
TA844	44mm Additional size



## Franklin 16 pce Impact Bit Socket Set 3/4" & 1" dr TA810

- 6 pt Heavy Duty Impact Bits: Hex 17 19 22 24
- Star: T60 T70 T80 T90 T100
- External Torx: E18 E20 E22 E24
- 1" Socket Adaptor • 3/4" Socket Adaptor • Hex key 4mm

### Features

- Chrome Molybdenum Steel, Black Phosphate Finish
- Laser Etched for Easy Identification, Tough Impact-resistant Carry Case
- Size Organised Storage Aids Tool Selection



Part No.	Description
810A1	1" drive adaptor
810A34	3/4" drive adaptor
810E18	E18
810E20	E20
810E22	E22
810E24	E24
810H17	17mm
810H19	19mm
810H22	22mm
810H24	24mm
810T60	T60
810T70	T70
810T80	T80
810T90	T90
81T100	T100



## Franklin Impact Extension Bars

### Features

- High Grade Chrome Molybdenum Steel
- Black Phosphate Finish

Part No.	Description
FT3494	3/4" dr Extension 100mm
FT3498	3/4" dr Extension 200mm
FT1098	1" dr Extension 200mm



## Franklin 10 pce 6 pt Metric Deep Socket Set 1/4" dr FT1410

- 4 5 6 7 8 9 10 11 12 13 mm

### Features

- High Grade Chrome Vanadium Steel
- Mirror Finish
- Socket Rail for Easy Storage
- Roll Marked Size For Easy Identification



## Franklin 7 pce 6 pt Deep Impact Socket Set 1" dr TA808

- 24 27 30 32 33 36 38mm

### Features

- Chrome Molybdenum Steel
- 6 Point Surface Drive
- Black Phosphate Finish
- Laser Etched for Easy Identification
- Tough Impact-resistant Carry Case
- Size Organised Storage Aids Tool Selection



Part No.	Description
TA924	24mm
TA927	27mm
TA928	28mm Additional size
TA930	30mm
TA932	32mm
TA933	33mm
TA936	36mm
TA938	38mm



## Franklin Power Bars

### Features

- Chrome Vanadium Steel Bar
- Mirror Plated Finish
- Heavy Duty

Part No.	Description
FT3818	450mm Power Bar 3/8" dr
TA720	600mm 1/2" dr
TA780	600mm 3/4" dr
TA720R	Replacement Head 1/2" dr
FT3819	Replacement Head 3/8" dr
TA780R	Replacement Head 3/4" dr



**Franklin 11 pce 6 pt Metric Surface Drive Socket Set 3/8" dr  
TA714**

8 10 11 12 13 14 15 16 17 18 19mm

**Features**

- High Grade Chrome Vanadium Steel
- Mirror Finish
- Roll Marked Size For Easy Identification
- Socket Rail for Easy Storage

Part No.	Description
FT408	8mm
FT410	10mm
FT411	11mm
FT412	12mm
FT413	13mm
FT414	14mm
FT415	15mm
FT416	16mm
FT417	17mm
FT418	18mm
FT419	19mm



**Franklin 11 pce 6 pt Metric Deep Socket Set 3/8" dr  
TA716**

8 10 11 12 13 14 15 16 17 18 19 mm

**Features**

- High Grade Chrome Vanadium Steel
- Mirror Finish
- Roll Marked Size For Easy Identification
- Socket Rail for Easy Storage

Part No.	Description
FT108	8mm x 3/8" dr
FT110	10mm x 3/8" dr
FT111	11mm x 3/8" dr
FT112	12mm x 3/8" dr
FT113	13mm x 3/8" dr
FT114	14mm x 3/8" dr
FT115	15mm x 3/8" dr
FT116	16mm x 3/8" dr
FT117	17mm x 3/8" dr
FT118	18mm x 3/8" dr
FT119	19mm x 3/8" dr



**Franklin 12 pce 12 pt Metric Socket Set 3/8" dr  
TA571**

8 9 10 11 12 13 14 15 16 17 18 19 mm

**Features**

- High Grade Chrome Vanadium Steel
- Mirror Finish
- Roll Marked Size For Easy Identification
- Socket Rail for Easy Storage

**Franklin 12 pce 12 pt Metric Deep Socket Set 3/8" dr  
TA570**

8 9 10 11 12 13 14 15 16 17 18 19 mm

**Features**

- High Grade Chrome Vanadium Steel
- Mirror Finish
- Roll Marked Size For Easy Identification
- Socket Rail for Easy Storage



**Franklin 10 pce 6 pt Surface Drive Socket Set 1/2" dr  
TA719**

10 11 12 13 14 15 16 17 18 19 mm

**Features**

- High Grade Chrome Vanadium Steel
- Mirror Finish
- High Visibility Size Markings
- Socket Rail for Easy Storage

Part No.	Description
FT910	10mm
FT911	11mm
FT912	12mm
FT913	13mm
FT914	14mm
FT915	15mm
FT916	16mm
FT917	17mm
FT918	18mm
FT919	19mm
FT920	20mm Additional Size
FT921	21mm Additional Size
FT922	22mm Additional Size
FT924	24mm Additional Size
FT927	27mm Additional Size
FT930	30mm Additional Size
FT932	32mm Additional Size





**Franklin 7 pce Ext Star Socket Set 1/4" & 3/8" dr**  
**SE100**

- 1/4" dr - E6 E7 E8
- 3/8" dr - E10 E12 E14 E16

**Features**

- High Grade Chrome Vanadium Steel Sockets
- Satin/Mirror Finish
- Roll Marked Size For Easy Identification
- Socket Rail for Easy Storage

Part No.	Description
SE104	1/4" dr E4 Additional Size
SE105	1/4" dr E5 Additional Size
SE106	1/4" dr E6
SE107	1/4" dr E7
SE108	1/4" dr E8
SE110	3/8" dr E10
SE111	3/8" dr E11 Additional Size
SE112	3/8" dr E12
SE114	3/8" dr E14
SE116	3/8" dr E16



**Franklin 18 pce Star Bit & Socket Set 3/8" dr**  
**SE600**

E7 E8 E10 E11 E12 E14 E16 E18 E20, T15 T20 T25 T27 T30 T40 T45 T50 T55

**Features**

- 3/8" Bit holder provided
- High Grade Chrome Vanadium Steel Sockets
- S2 Steel Bits
- Satin Finish with Anti-Slip Knurl
- Supplied in blow moulded case
- Roll Marked Size For Easy Identification

Part No.	Description
TX20BO	20 x 30mm (2) x 8mm Hex
TX25BO	25 x 30mm (2) x 8mm Hex
TX27BO	27 x 30mm (2) x 8mm Hex
TX30BO	30 x 30mm (2) x 8mm Hex
TX40BO	40 x 30mm (2) x 8mm Hex
TX45BO	45 x 30mm (2) x 8mm Hex
TX50BO	50 x 30mm (2) x 8mm Hex
TX55BO	55 x 30mm (2) x 8mm Hex
TP238	Bit Holder 3/8" Sq dr



**Franklin 9 pce Ext Star Socket Set 1/2" dr**  
**SE200**

E10 E11 E12 E14 E16 E18 E20 E22 E24

**Features**

- High Grade Chrome Vanadium Steel
- Mirror Finish
- High Visibility Size Markings
- Socket Rail for Easy Storage

**Franklin 10 pce Crowfoot Wrench Set 3/8" dr**  
**TA701**

10 11 13 14 15 17 19 21 22 24 mm

**Features**

- High Grade Chrome Vanadium Steel
- Mirror Finish
- Roll Marked Size For Easy Identification
- Socket Rail for Easy Storage



**Franklin 7 pce Star Plus Bit Set 1/4" dr**  
**TSP1**

T10 T15 T20 T25 T27 T30 T40 5 point tamperproof Bits For Tamperproof Five Point Torx Plus Type Fasteners. Used on ECU's, Diesel Pumps etc.

**Features**

- High Grade Chrome Vanadium Steel Sockets
- S2 Steel Bits
- Satin Finish
- Roll Marked Size For Easy Identification
- Socket Rail for Easy Storage



**XF Socketry**

Supplied in industry approved EVA foam



**See Section B**

**Franklin 7 pce Star Bit Socket Set 1/4" dr**  
**TA569**

T10 T15 T20 T25 T27 T30 T40 X 37mm

**Features**

- High Grade Chrome Vanadium Steel Sockets
- S2 Steel Bits
- Mirror Finish with Anti-Slip Knurl
- Roll Marked Size For Easy Identification
- Socket Rail for Easy Storage



Part No.	Description
TS110	T10
TS115	T15
TS120	T20
TS125	T25
TS127	T27
TS130	T30
TS140	T40



**Franklin 15 pce 12 pt Socket Set 1" dr**  
**FT1015**

36 41 46 50 55 60 65 70 75 80 mm

- Extension Bars 200 400mm • Ratchet Head • 540mm Sliding T bar

**Features**

- Chrome Vanadium Steel
- 12 Point Surface Drive
- Size marked for easy identification
- Tough Metal Carry Case
- Segmented Storage keeps contents neatly arranged



Part No.	Description
XL936	36mm
XL941	41mm
XL946	46mm
XL950	50mm
XL955	55mm
XL960	60mm
XL965	65mm
XL970	70mm
XL975	75mm
XL980	80mm
XL1008	200mm ext bar
XL1016	400mm ext bar
XL1021	540mm sliding T bar
XL1001	Ratchet Head



**Franklin Combination Bit Set 42 pce 3/8" & 1/2" dr**  
**4340**

14 - Hex bits 30mm and 75mm 4 5 6 7 8 10 12mm

10 - 12 pt Spline bits 30mm and 75mm M5 M6 M8 M10 M12

16 - Star bits 30mm and 75mm T20 T25 T30 T40 T45 T50 T55 T60

2 - Bit Holders 1/2" and 3/8" dr

**Features**

- High Grade Chrome Vanadium
- S2 Steel Bits
- Supplied in Blow Moulded Case



Part No.	Description
T4304	4 x 30mm x 10mm Hex
T4305	5 x 30mm x 10mm Hex
T4306	6 x 30mm x 10mm Hex
T4307	7 x 30mm x 10mm Hex
T4308	8 x 30mm x 10mm Hex
T4310	10 x 30mm x 10mm Hex
T4312	12 x 30mm x 10mm Hex
T4405	M5 x 30mm x 10mm Hex
T4406	M6 x 30mm x 10mm Hex
T4408	M8 x 30mm x 10mm Hex
T4410	M10 x 30mm x 10mm Hex
T4412	M12 x 30mm x 10mm Hex
T5304	4 x 75mm x 10mm Hex
T5305	5 x 75mm x 10mm Hex
T5306	6 x 75mm x 10mm Hex
T5307	7 x 75mm x 10mm Hex
T5308	8 x 75mm x 10mm Hex
T5310	10 x 75mm x 10mm Hex
T5312	12 x 75mm x 10mm Hex
T5405	M5 x 75mm x 10mm Hex
T5406	M6 x 75mm x 10mm Hex
T5408	M8 x 75mm x 10mm Hex
T5410	M10 x 75mm x 10mm Hex
T5412	M12 x 75mm x 10mm Hex
TP138	10mm Hex 3/8" dr
TP312	10mm Hex 1/2" dr
TS420	T20 x 30mm x 10mm Hex
TS425	T25 x 30mm x 10mm Hex
TS430	T30 x 30mm x 10mm Hex
TS440	T40 x 30mm x 10mm Hex
TS445	T45 x 30mm x 10mm Hex
TS450	T50 x 30mm x 10mm Hex
TS455	T55 x 30mm x 10mm Hex
TS460	T60 x 30mm x 10mm Hex
TS520	T20 x 75mm x 10mm Hex
TS525	T25 x 75mm x 10mm Hex
TS530	T30 x 75mm x 10mm Hex
TS540	T40 x 75mm x 10mm Hex
TS545	T45 x 75mm x 10mm Hex
TS550	T50 x 75mm x 10mm Hex
TS555	T55 x 75mm x 10mm Hex
TS560	T60 x 75mm x 10mm Hex





**Franklin 7 pce Tamperproof Star Bit Set 3/8" dr  
TP100**

T20 T25 T30 T40 T45 T50  
TP138 - 3/8" dr socket adaptor

- Features**
- High Grade Chrome Vanadium Steel Socket
  - S2 Steel Bits
  - Supplied in Metal Case



Part No.	Description
TP120	T20 x 30mm x 10mm
TP125	T25 x 30mm x 10mm
TP127	T27 x 30mm x 10mm
TP130	T30 x 30mm x 10mm
TP140	T40 x 30mm x 10mm
TP145	T45 x 30mm x 10mm
TP150	T50 x 30mm x 10mm
TP155	T55 x 30mm x 10mm
TP320	T20 x 75mm x 10mm Additional Size
TP325	T25 x 75mm x 10mm Additional Size
TP327	T27 x 75mm x 10mm Additional Size
TP330	T30 x 75mm x 10mm Additional Size
TP340	T40 x 75mm x 10mm Additional Size
TP345	T45 x 75mm x 10mm Additional Size
TP350	T50 x 75mm x 10mm Additional Size
TP355	T55 x 75mm x 10mm Additional Size

**Franklin 7 pce Star Bit Set 3/8" dr  
TS100**

T20 T25 T30 T40 T45 T50 - 3/8" dr socket adaptor  
TP138 - 3/8" dr socket adaptor

- Features**
- High Grade Chrome Vanadium Steel Socket
  - S2 Steel Bits
  - Supplied in Metal Case



Part No.	Description
TS420	T20 x 30mm x 10mm Hex
TS425	T25 x 30mm x 10mm Hex
TS430	T30 x 30mm x 10mm Hex
TS440	T40 x 30mm x 10mm Hex
TS445	T45 x 30mm x 10mm Hex
TS450	T50 x 30mm x 10mm Hex

**Irwin 5 pce Bolt Grip Set 3/8" dr  
A04634**

10mm (3/8"), 11mm (7/16"), 13mm (1/2"), 14mm (9/16"), 16mm (5/8")

- Features**
- Bolt grip for removing rounded, rusty or painted bolts
  - Unique reverse spiral flute design securely grips and removes stubborn nuts and bolts
  - Can be used with a hand ratchet 3/8" square drive
  - Has hexagon flats for use with a spanner or adjustable wrench
  - Universal lobular design for all types of fasteners



**Irwin 7 pce Powergrip Set  
A39410**

3/16" 1/4" 5/16" (8mm) 3/8" 10mm 7/16" (11mm) 1/2"

- Features**
- Reverse spiral flutes for maximum gripping power
  - Universal shape fits metric & fractional size
  - 1/4 inch hexagon shank suitable for use with power drills and nut drivers
  - Durable high carbon steel for longer life



**Irwin 5 pce Bolt Grip Expansion Set 3/8" dr  
A04635**

8mm (5/16"), 10mm (3/8"), 13mm (1/2"), 11/16", 19mm (3/4")

- Features**
- Bolt grip for removing rounded, rusty or painted bolts
  - Unique reverse spiral flute design securely grips and removes stubborn nuts and bolts
  - Can be used with a hand ratchet 3/8" square drive
  - Has hexagon flats for use with a spanner or adjustable wrench
  - Universal lobular design for all types of fasteners



**Irwin 5 pce Bolt Grip Set 1/2" dr  
A54125**

3/4" (19mm), 13/16" (21mm), 7/8" (22mm), 15/16" (24mm), 1" (25mm)

- Features**
- Bolt grip for removing rounded, rusty or painted bolts
  - Unique reverse spiral flute design securely grips and removes stubborn nuts and bolts
  - Can be used with a hand ratchet 1/2" square drive
  - Has hexagon flats for use with a spanner or adjustable wrench
  - Universal lobular design for all types of fasteners



**Franklin 7 pce Lock Nut Removal Tool Set 1/2" dr**  
**FT707**

17 18.5 20 21.5 23 24.5 26 mm - 1/2" dr, Left Hand Threaded Sockets

**Features**

- For removing security wheel nuts (when the key has been lost), damaged wheel nuts and other threaded studs/fasteners
  - Internal left hand reverse threads
  - Chrome Molybdenum Steel
  - Tough Impact Resistant Carry Case
- N.B This is not normally suitable for use on security wheel nuts with rotating outer sleeves

Part No.	Description
FT7071	17mm
FT7072	18.5mm
FT7073	20mm
FT7074	21.5mm
FT7075	23mm
FT7076	24.5mm
FT7077	26mm



1/2"



**Franklin Hub Nut Sockets**

TA965 - IVECO rear hub nuts. Daily 35-8 35-10 49-10 49-12 59-12 etc.

**Features**

- Chrome Vanadium Steel
- Roll Marked Size For Easy Identification

Part No.	Description
TA781	50mm 12pt
TA782	56mm 12pt
TA783	65mm 6pt
TA965	65mm 12PT



**Franklin Converter Adaptors**

**Features**

- Chrome Vanadium Steel
- Mirror Plated Finish



Part No.	Description
FT1238	3/8" F 1/2" M
FT3812	1/2" F 3/8" M
FT1234	3/4" F 1/2" M
FT3412	1/2" F 3/4" M



**Franklin 12 pt Bi-Hex Deep Plated Socket**  
**1/2" dr 36mm**

**TA736**

For use on Lancia Hub Nuts and various Gearbox Applications

**Features**

- Chrome Vanadium Steel
- Roll Marked Size For Easy Identification
- Mirror Finish



**Franklin Specialised Impact Sockets**

**Features**

- High Grade Chrome Molybdenum Steel
- Black Phosphate Finish
- Roll marked size markings (for easy identification)

Part No.	Description
TA722	36mm
TA723	1 5/16"
TA724	1 13/16"/46mm (CRV)
TA725	1 1/2"/38mm



**Franklin 6 pt 45mm Hub Nut Socket 3/4" dr**  
**TA789**

Deep Impact Socket BMW 3 + 5 Series hub Nuts

**Features**

- Chrome Vanadium Steel
- Impact Quality - Black Phosphate Finish
- Roll marked size markings (for easy identification)



**Franklin 2 pce Converter Set 1/4" & 3/8" dr**  
**FT1438**

1/4" Female 3/8" Male

1/4" Male 3/8" Female

**Features**

- Chrome Vanadium Steel
- Bright Plated Finish





## Franklin 3 pce Socket Driver Set 1/4" 3/8" & 1/2" dr 4130

Socket Driver Set 1/4" 3/8" 1/2" dr  
6mm hexagon - impact adaptors for use with variable speed drill / screwdriver



1/4" 3/8" 1/2"



## Franklin 3 pce Wobble and Fixed Extension Bar Set 1/4" dr FT1401

Two stage - fixed / wobble 50 100 150mm

### Features

- Chrome Vanadium Steel
- Bright Plated Finish
- Anti-Slip Knurl
- Sturdy storage case



1/4"



## Franklin 3 pce Wobble + Fixed Extension Bar Set 1/2" dr FT1201

Two stage - fixed / wobble 50 125 250mm

### Features

- Chrome Vanadium Steel
- Bright Plated Finish
- Anti-Slip Knurl
- Sturdy storage case



1/2"



## Franklin Socket Rails

### SR80

#### Features

- Heavy Duty
- Four rails
- 20 pcs 1/4" dr
- 30 pcs 3/8" dr
- 30 pcs 1/2" dr
- Includes rear hanger

### SR110

#### Features

- 30 clips for 1/2" sq dr
- 30 clips for 3/8" sq dr
- 30 clips for 1/4" sq dr
- 20 1/4" hex screwdriver bits



1/4" 3/8" 1/2"



## Franklin Universal Joints

Head swings through 90° in both directions

### Features

- Spring loaded ball bearing for secure socket holding
- Chrome Vanadium Steel
- Bright plated finish



Part No.	Description
FT1404	1/4" dr Universal Joint
FT3804	3/8" dr Universal Joint
FT1204	1/2" dr Universal Joint

1/4" 3/8" 1/2"



## Franklin 4 pce Wobble and Fixed Extension Bar Set 3/8" dr FT3801

Two stage - fixed / wobble 35 75 150 250mm

### Features

- Chrome Vanadium Steel
- Bright Plated Finish
- Anti-Slip Knurl
- Sturdy storage case



3/8"



## Franklin Magnetic Socket Trays Deep

Magnetic Socket Tray. Ideal for use with top and bottom tool boxes.

### Features

- Holds deep and shallow sockets
- Maximum socket size 14mm (5/8")
- Magnet holds tray onto flat steel surfaces



Part No.	Description
AST14	1/4" dr Stores 26 Sockets
AST38	3/8" dr Stores 28 Sockets
AST12	1/2" dr Stores 22 Sockets

1/4" 3/8" 1/2"



## Franklin Socket Rails

### Features

- Socket Rail 1/4" dr 300mm (12") 18 clips 1/4" sq dr
- Socket Rail 3/8" dr 300mm (12") 11 clips 3/8" sq dr
- Socket Rail 1/2" dr 300mm (12") 10 clips 1/2" sq dr



Part No.	Description
SR1412	300mm 18 clips 1/4" dr
SR3812	300mm 11 clips 3/8" dr
SR1212	300mm 10 clips 1/2" dr

1/4" 3/8" 1/2"



## Norbar Torque Screwdrivers

The Norbar TTI Torque Wrenches are accurate, easy to set and are comfortable in use. They are finished in an attractive and durable satin chrome plate.

### Product Details

- R13850 - 1/4" HEX 0.3-1.5 Nm
- R13851 - 1/4" HEX 0.6-3.0 Nm
- R13852 - 1/4" HEX 1.2-6.0 Nm

### Features

- Supplied with a 1/4" hexagon bit holder designed using a 4mm hexagon stem.
- Easy torque adjustment without the need of additional specialist tools.
- All tools feature a lock to prevent accidental adjustment of set torque.
- Accuracy exceeds the requirements of ISO6789.
- Traceable calibration certificate for the clockwise direction supplied with all adjustable tools. (not 'P' Types).
- Tool 'slips' when torque is achieved removing the possibility of 'over-tightening'.
- Comfortable, durable handle. The handle is constructed using two materials; a base material for strength overlaid with a soft feel grip for comfort and slip resistance.

Part No.	Description
R13850	0.3-1.5 Nm
R13851	0.6-3.0 Nm
R13852	1.2-6.0 Nm



## Norbar Torque Wrenches

The NorTorque utilises Norbar's proven mechanism and internal components and built them into a purposeful and attractive torque wrench.

### Product Details

- R30101 - Norbar NorTorque 60 3/8" dr 12-60Nm 10-45lbf.ft
- R30103 - Norbar NorTorque 100 1/2" dr 20-100Nm 15-75lbf.ft
- R30104 - Norbar NorTorque 200 1/2" dr 40-200Nm 30-150lbf.ft
- R30105 - Norbar NorTorque 300 1/2" dr 60-300Nm 45-220lbf.ft
- R30106 - Norbar NorTorque 340 1/2" dr 60-340Nm 50-250lbf.ft

### Features

- Accurate to  $\pm 3\%$  of reading to exceed the requirements of ISO6789
- Light and fast adjustment saves operator time and effort
- Micrometer scale applying to the primary torque units (Nm on a dual scale wrench) for simple and error free setting
- "Push through" ratchets allow torque control in clockwise and anti-clockwise directions
- Retained square drive will not pull out of the ratchet head when socket is removed
- Narrow engagement angles of 5° on Models 60 to 200, 6° on Models 300 and 340. Allows for easy positioning of the tool in confined spaces
- Push/pull lock is fast and intuitive to use and prevents accidental adjustment of set torque
- Convenient hanger feature for tool storage and also aids wrench unlocking and adjustment



Part No.	Description
R30101	3/8" dr 12-60Nm 10-45lbf.ft (includes 3/8"F to 1/2"M adaptor)
R30103	1/2" dr 20-100Nm 15-75lbf.ft (includes 1/2"F to 3/8"M adaptor)
R30104	1/2" dr 40-200Nm 30-150lbf.ft
R30105	1/2" dr 60-300Nm 45-220lbf.ft
R30106	1/2" dr 60-340Nm 50-250lbf.ft



## Norbar TTI Torque Wrenches

TTi Torque Wrenches are accurate, easy to set and are comfortable in use

- RNT201 - 1/4"dr 4-20Nm (35 - 180lbf-in) 230mm Reversible
- RNT20 - 3/8"dr 4-20Nm (35 - 180lbf-in) 230mm

### Features

- Accuracy:  $\pm 3\%$  of reading exceeds all international standards for torque wrenches
- Each wrench is supplied with a traceable calibration certificate.
- Micrometer Scale for simple and error free setting
- Quick and Light Adjustment
- Comfortable, Durable Handle with a soft feel grip for comfort and slip resistance

Part No.	Description
RNT201	1/4"dr 4-20Nm (35 - 180lbf-in) 230mm
RNT20	3/8"dr 4-20Nm (35 - 180lbf-in) 230mm



## Norbar TT Torque Wrench 3/4" dr 80-400 Nm 675cm

### RNT400

The New Professional torque wrench has been re-engineered to be even more accurate, durable and easy to use. The square drive features a finger grip on the top ('mushroom' head) that assists with running down the nut until resistance is met.

### Technical Specifications

- Length: 686 mm
- Square Size: 3/4"
- Weight: 1.93 Kg
- Ratchet Teeth: 60
- Ratchet Type: Industrial 'Mushroom' head
- Ratchet Diameter: 51 mm

### Features

- Factory calibrated to  $\pm 3\%$  and our new mechanism ensures that the accuracy is retained for longer.
- Every wrench is supplied with a calibration certificate
- Ergonomic new handle with a high proportion of soft-feel, high grip material.
- Handle material and lens resist all chemicals in common automotive, industrial and aviation use.
- Secure push/pull locking mechanism is quick and intuitive to use and prevents accidental adjustment.
- Large scale window and long scale length for great visibility and accurate setting.
- Unique on a torque wrench, the TimeStrip® gives a visual indication that the wrench is due for re-calibration.





## Norbar Industrial Torque Wrenches

The Industrial Range of Torque Wrenches has a 'Break Back' action providing an unmistakable signal that can be seen and felt when the set torque is reached.

### Product Details

- RN3AR - 3/4" dr 100-500Nm 910mm 5.2kg
- RN4R - 3/4" dr 150-700Nm 1150mm 6.3kg
- RN5R - 3/4" dr 300-1000Nm 1475mm 7.3kg
- RN5AR - 1" dr 700-1500Nm 1475mm 10.4kg
- R34SQ - N12297 3/4' Square Coupler
- R1SQ - 1' sq dr Coupler (3/4">1")

### Features

- Every wrench comes supplied with a calibration certificate.
- Robust construction gives accurate results,  $\pm 4\%$ , even in arduous working conditions.
- The break angle improves accuracy by reducing the possibility of over torquing.
- Dual scaled, N.m and lbf.ft.
- All models are also available as Production 'P' types with no setting scale. These must be set against a torque testing device such as Norbar's Professional Torque Tester.

Part No.	Description
RN3AR	3/4" dr 150-700Nm 1150mm 6.3kg
RN4R	3/4" dr 150-700Nm 1150mm 6.3kg
RN5R	3/4" dr 300-1000Nm 1475mm 7.3kg
RN5AR	1" dr 700-1500Nm 1475mm 10.4kg
R34SQ	Norbar 3/4' Square Coupler
R1SQ	Norbar 1' sq dr Coupler (3/4" to 1")



## Norbar Torque Multipliers

The 'Highwayman' torque multiplier has been designed for use where it is necessary to provide higher torques than would otherwise be possible due to limitations of space or operator strength. Input to the multiplier is via a ratchet torque wrench set to one fifth of the desired output torque.

### RNHT3 - Technical Specifications

- Tool Weight: 3.8 Kg, Multiplication Ratio: 5:1
- Output Square: 3/4", Input Square: 1/2"
- Velocity Ratio: 5.333:1, Plate Weight: 1.3 Kg

### RNHT31 - Technical Specifications

- Tool Weight: 3.8 Kg, Multiplication Ratio: 5:1
- Output Square: 1", Input Square: 3/4"
- Velocity Ratio: 5.333:1, Plate Weight: 1.3 Kg

### Features

- 5:1 torque multiplication, accuracy guaranteed better than  $\pm 4\%$
- Supplied with two reaction bar styles for maximum versatility
- Robust construction means minimal maintenance and long life
- Supplied in a carrying case
- 1300 N.m version has a spare 3/4" output square included in the kit

Part No.	Description
RNHT3	1300Nm
RNHT31	2700Nm



## Franklin Torque Wrench 3/8" dr

### TA651

88-708 in lb / 10-80 Nm

### Features

- Chrome Vanadium Drive
- Chrome Alloy Plated
- No Pointer or Dial to Monitor
- Micrometer Adjustment
- Right hand click only



## Franklin Torque Wrench 3/8" dr

### TA652

2-24 Nm

### Features

- Chrome Vanadium Drive
- Chrome Alloy Plated
- Micrometer Adjustment
- Right hand click only
- Tough Impact Resistant Carry Case



## Franklin Torque Wrench 1/2" dr TA65

TUV GS Approved 30 - 155 lb ft / 40 - 210 Nm

### Features

- Chrome Vanadium Drive
- Chrome Alloy Plated
- Right hand click only
- Micrometer Adjustment
- No Pointer or Dial to Monitor

Part No.	Description
TA65R	Ratchet Service Kit



1/2"



## Franklin Torque Wrench Accessories

TA66 - Angular Torque Gauge 1/2" dr

To allow Fasteners to be Set Simply and Accurately to their Maximum Safe Working Load

### Features

- 1/2" dr Plug and Socket
- Friction Grip Cursor
- Easily Zeroed
- Clear Scale with 2 Degree Increments
- Adjustable Reaction Arm

TA666 - 1/2" dr - 0-150 ft lb / 0-20 Mkg

### Features

- Dual Scale for Forward/Reverse Operations
- Uses the Deflection of the Main Spring Beam to Measure The Torque Applied
- The Scale is graduated in m/kg and lb-ft in Two Directions

Part No.	Description
TA66	Angular Torque Gauge 1/2" dr
TA666	1/2" dr - 0-150 ft lb / 0-20 Mkg



1/2"





# Spanners - F

## Contents

Spanners Ring	F2
Spanners Combination	F2
Spanners Star	F4
Spanners Adjustable	F4

## GearF™ Spanners

GearF - Franklin Lifetime Warranty  
Supplied in industry approved EVA foam



See Section C

2020

[www.franklin-tools.co.uk](http://www.franklin-tools.co.uk)

**GearF™  
Spanners**

**GearF - Franklin Lifetime Warranty**  
Supplied in industry approved EVA foam



**See Section C**

**Franklin 8 pce 12 pt Ring Spanner Set  
FB701**

6 x 7, 8 x 9, 10 x 11, 12 x 13, 14 x 15 16 x 17, 18 x 19, 20 x 22mm

**Features**

- Chrome Vanadium Steel
- Hardened and Tempered
- Mirror Finish
- Plated to prevent corrosion
- Manufactured to DIN Standards
- Storage rack



**Franklin 25 pce 12 pt Combination Spanner Set  
FB602**

6 7 8 9 10 11 12 13 14 15 16 17 18 19 20 21 22 23 24 25 26 27 28 30 32 mm

**Features**

- Chrome Vanadium Steel
- 12 Point Surface Drive - Ring End
- Hardened and Tempered
- Mirror Finish
- Plated to prevent corrosion
- Manufactured to DIN Standards
- Storage tray



Part No.	Description
FB606	6mm
FB607	7mm
FB608	8mm
FB609	9mm
FB610	10mm
FB611	11mm
FB612	12mm
FB613	13mm
FB614	14mm
FB615	15mm
FB616	16mm
FB617	17mm
FB618	18mm
FB619	19mm
FB620	20mm
FB621	21mm
FB622	22mm
FB623	23mm
FB624	24mm
FB625	25mm
FB626	26mm
FB627	27mm
FB628	28mm
FB630	30mm
FB632	32mm

**Franklin 18 pce 12 pt Combi Spanner Set  
FB601**

6 7 8 9 10 11 12 13 14 15 16 17 18 19 20 21 22 24 mm

**Features**

- Chrome Vanadium Steel, Hardened and Tempered
- 12 Point Surface Drive - Ring End
- Mirror Finish
- Plated to prevent corrosion
- Manufactured to DIN Standards
- Storage tray



**Franklin 10 pce 12 pt Short Combi Spanner Set  
FB702**

10 11 12 13 14 15 16 17 18 19 mm

**Features**

- Chrome Vanadium Steel
- 12 Point Surface Drive - Ring End
- Hardened and Tempered
- Mirror Finish
- Plated to prevent corrosion
- Manufactured to DIN Standards
- Storage tray



**Franklin 6 pce 12 pt Combination Spanner Set  
FB603**

34 36 38 41 46 50 mm

**Features**

- Chrome Vanadium Steel
- 12 Point Surface Drive - Ring End
- Hardened and Tempered
- Mirror Finish
- Plated to prevent corrosion
- Manufactured to DIN Standards
- Storage tray



Part No.	Description
FB633	33mm Additional Size Available
FB634	34mm
FB636	36mm
FB638	38mm
FB641	41mm
FB646	46mm
FB650	50mm



## Franklin 12 pce 12 pt XL Combi Spanner Set FB802

8 9 10 11 12 13 14 15 16 17 18 19mm

### Features

- Chrome Vanadium Steel, Hardened and Tempered
- 12 Point Surface Drive - Ring End
- Mirror Finish
- Plated to prevent corrosion
- Manufactured to DIN Standards
- Storage rack



## Franklin Adjustable Speed Wrenches

Quality adjustable speed wrench

### Features

- Quick action wrench
- Ratchet action
- Grips most shapes including rounded nuts
- Dipped handle for comfort and grip

Part No.	Description
92-8	8-17mm
92-12	14-32mm



## KS Tools Ratcheting Adjustable Wrench E57702

250mm 10" - Capacity 32mm (1.1/4")

### Features

- Jaw 15 degree offset, Ratchet function
- Chrome Vanadium, Matt finish



## Franklin 4 pce Star Ring Spanner Set FB404

E6 x E8, E10 x E12, E14 x E18, E20 x E24

### Features

- Chrome Vanadium Steel
- Mirror Finish
- Storage rack



## Franklin Adjustable Wrenches 9500

- 9506 - 6" x 18mm
- 9508 - 8" x 26mm
- 9510 - 10" x 30mm
- 9512 - 12" x 35mm

### Features

- Drop forged carbon steel hardened and tempered
- Supplied in a roll

Part No.	Description
9506	6" x 18mm Jaw
9508	8" x 26mm Jaw
9510	10" x 30mm Jaw
9512	12" x 35mm Jaw
9515	15" x 45mm Jaw Additional Size Available



# Screwdrivers - G

## Contents

Wera	G2
Bit Sets	G5
Hex Keys	G9

# Gear **F**™ Screwdrivers

GearF - Franklin Lifetime Warranty  
Supplied in industry approved EVA foam



See Section **C**

# 2020

[www.franklin-tools.co.uk](http://www.franklin-tools.co.uk)



# GearF™ Screwdrivers

GearF - Franklin Lifetime Warranty  
Supplied in industry approved EVA foam



See Section C

## Wera 3pce Long Screwdriver Set V47735

- Slotted 5.5mm x 300mm
- PH2 x 300mm
- PZ2 x 300mm

### Features

- Screwdrivers for slotted and cross-recess Phillips and Pozidriv screws
- Multi-component Kraftform handle for fast and ergonomic screwdriving
- Colour coding according to profile and size
- Hexagonal anti-roll feature against rolling away
- Extra-long blade for low-lying working situations



## Wera 6 pce Chiseldriver Set AW8287

- 0.6 x 3.5 x 80
- 0.8 x 4.5 x 90
- 1.0 x 5.5 x 100
- 1.2 x 7.0 x 125
- PZ1 x 80
- PZ2 x 100 mm

### Features

- Chiseldriver for fastening, chiselling and loosening
- Impact cap and bolster for the transfer of higher torque
- Hexagonal blade extending through the handle
- The Wera Black Point tip offers an exact fit and optimum corrosion protection
- Handle markings simplify finding and sorting of tools
- Storage rack for wall-mounting



Part No.	Description
V17005	PH1 x 80 Additional Size
V17010	PH2 x 100 Additional Size
V17015	PH3 x 150 Additional Size
V17050	PZ1 x 80
V17052	PZ2 x 100
V17054	PZ3 x 150 Additional Size
V18260	3.5 x 80
V18262	4.5 x 90
V18264	5.5 x 100
V18266	7.0 x 125
V18268	9.0 x 150 Additional Size
V18270	10.0 x 175 Additional Size
V18272	12.0 x 200 Additional Size
V18274	14.0 x 250 Additional Size

## Wera 6pce Lasertip Screwdriver Set AW5656

- 0.5 x 3.0 x 80
- 0.8 x 4.0 x 100
- 1.0 x 5.5 x 125
- 1.2 x 6.5 x 150
- PZ1 x 80
- PZ2 x 100 mm

### Features

- Screwdriver for slotted and Pozidriv screws
- Multi-component Kraftform handle for fast and ergonomic screwdriving
- Colour coding according to profile and size
- Hexagonal anti-roll feature against rolling away
- Lasertip tips for more secure fit in the screw head
- Storage rack for wall-mounting



Part No.	Description
V08060	5.5 x 300 Additional Size
V09310	PZ1 x 80
V09313	PZ1 x 300 Additional Size
V09315	PZ2 x 100
V09319	PZ2 x 300 Additional Size
V10001	3.0 x 80
V10004	4.0 x 100
V10007	5.5 x 125
V10010	6.5 x 150

## Wera 6 pce Torx Screwdriver Set AW8062

- TX10 x 80
- TX15 x 80
- TX20 x 100
- TX25 x 100
- TX30 x 115
- TX40 x 130 mm

### Features

- Screwdriver for TORX® screws
- Multi-component Kraftform handle for fast and ergonomic screwdriving
- Handle markings simplify finding and sorting of tools
- Hexagonal anti-roll feature against rolling away
- Holding function for TORX® screws
- Storage rack for wall-mounting



Part No.	Description
V28000	TX5 x 60 Additional Size
V28001	TX6 x 60 Additional Size
V28002	TX7 x 60 Additional Size
V28003	TX8 x 60 Additional Size
V28004	TX9 x 60 Additional Size
V28005	TX10 x 80
V28008	TX15 x 80
V28010	TX20 x 100
V28012	TX25 x 100
V28013	TX27 x 115 Additional Size
V28015	TX30 x 115
V28020	TX40 x 130

**Wera 6pce Tamper Torx Screwdriver Set  
AW3825**

- TP10 x 80
- TP15 x 80
- TP20 x 100
- TP25 x 100
- TP30 x 115
- TP40 x 130 mm

**Features**

- Screwdriver for Tamperproof TORX® screws; holding function
- Multi-component Kraftform handle for fast and ergonomic screwdriving
- Handle markings simplify finding and sorting of tools
- Hexagonal anti-roll feature against rolling away
- Holding function for Tamperproof TORX® screws, chrome-plated
- Storage rack for wall-mounting



Part No.	Description
V38257	TP7 x 60 Additional Size
V38258	TP8 x 60 Additional Size
V38259	TP9 x 60 Additional Size
V38260	TP10 x 80
V38261	TP15 x 80
V38262	TP20 x 100
V38263	TP25 x 100
V38264	TP27 x 115 Additional Size
V38265	TP30 x 115
V38266	TP40 x 130
V38270	TP20 x 300 Additional Size



**Wera 7 pce Kraftform VDE 1000v  
AW1575**

- 0.4 x 2.5 x 80 mm
- 0.6 x 3.5 x 100 mm
- 0.8 x 4.0 x 100 mm
- 1.0 x 5.5 x 125 mm
- PH1 x 80 mm
- PH2 x 100 mm
- Mains Tester

**Features**

- Multi-component Kraftform handle for fast and low-fatigue working
- Handle markings simplify finding and sorting of tools
- Hexagonal anti-roll feature against rolling away
- The Wera Black Point tip offers an exact fit and optimum corrosion protection
- Individually tested



**Wera 6 pce Torx Chiseldriver Set  
AW2441**

- TX15 x 80
- TX20 x 90
- TX25 x 100
- TX27 x 125
- TX30 x 150
- TX40 x 150 mm

**Features**

- Chiseldriver for fastening, chiselling and loosening
- For recessed TORX® screws
- Hexagonal blade extending through the handle
- Impact cap and bolster for the transfer of higher torque
- Storage rack for wall-mounting



Part No.	Description
V24400	TX15 x 80
V24401	TX20 x 90
V24402	TX25 x 100
V24403	TX27 x 125
V24404	TX30 x 150
V24405	TX40 x 150



**Wera Star Magnetiser  
A38098**

**How to use**

- To Magnetise - Simply run the tool down the positive side of the magnetiser/demagnetiser and your tool immediately becomes magnetised and is able to hold the screw securely on the blade.
- To Demagnetise - Simply run the tool down one of the four negative sides

**Features**

- To magnetise and demagnetise tool tips
- Securely holds the screw on the tool



**Franklin 30 in 1 Precision Scwdriver Set  
9730**

- 9 Star T4 T5 T6 T7 T8 T9 T10 T15 T20
- 8 Hexagon 0.7mm 0.9mm 1.3mm 1.5mm 2.0mm 2.5mm 3.0mm 4.0mm
- 7 Slotted 1.0mm 1.5mm 2.0mm 2.5mm 3.0mm 3.5mm 4.0mm
- 4 Phillips #000 #00 #0 #1
- 2 Pozi #0 #1

**Features**

- Ergonomic Easy Grip Handle
- Housed in a plastic case with neat bit storage compartments





## Franklin Impact Driver Set 2500

Hand held reversible impact driver

- Impact driver handle
- 1/2" sq dr adaptor
- 4 x screwdriver bits
- 8mm (5/16") Slotted x 36mm
- 10mm (3/8") Slotted x 36mm
- PH2 x 36mm
- PH3 x 36mm

Part No.	Description
1440	Impact Driver Bit Set

### Features

- Anti-clockwise impact action to help release seized nuts and bolts
- Reversible head permits clockwise use
- Tough Impact Resistant Case



## Irwin Torx Power Bits

Power bits are specifically designed for the higher torque requirements of power tools

### Features

- Manufactured with industrial-grade S2 steel
- Designed to provide more clearance between the power tool and the fastener

Part No.	Description
A04373	TX20 - 50mm - 5 pce
A04374	TX25 - 50mm - 5 pce
A04375	TX30 - 50mm - 5 pce
A04376	TX40 - 50mm - 5 pce



## Irwin 30 pce Power Bit Set A04385

- Phillips : PH1, 5 X PH2, PH3
- Pozidrive : PZ1, 5 X PZ2, PZ3
- Torx : T20, T25, T30, T40
- Slotted : SL6-8, SL8-10, SL10-12
- Nut Set : 6,8,10,12mm
- Double Ends : PH2/PH2, PH2/PZ1, 2 X PZ2/PZ2
- Bit Holder
- Tough Impact Resistant Case



## Franklin 33 pce Security Bit Set 1/4" Hex TP400

Suitable for use on most popular tamperproof fasteners

- Torq 6 8 10mm
- Spanner 4 6 8 10mm
- Tri-Wing 1 2 3 4
- Hexagon 2 2.5 3 4 5 6mm
- Hexagon 5/32" 9/64" 1/8" 7/64" 3/32" 5/64"
- Star TS8 10 15 20 25 27 30 35 40

### Features

- S2 Chrome Vanadium Steel Bits
- 60mm magnetic bit holder
- Moulded plastic case for bit and holder storage



# GearF™

## Screwdrivers

**GearF - Franklin Lifetime Warranty**  
Supplied in industry approved EVA foam

## See Section C

## Irwin Impact Double - Ended Power Bits

Engineered for maximum durability and long life with impact drivers

These bits are designed with precision tip geometry so they fit fasteners more precisely

### Features

- Heavy-duty, cold-forged, high-grade steel
- Black oxide finish
- Resists corrosion
- Can withstand high torque output

Part No.	Description
A23377	PH2 100mm - 2 pce
A23410	PZ2 100mm - 2 pce
A23407	PZ1 100mm - 2 pce



## Franklin 33 pce Screwdriver Bit Set 1/4" Hex TP500

Ideal Accessory for Drills and Cordless or Magnetic Screwdrivers

- 8 x Phillips No's 0, 1, 2, 3, 7 x Pozidriv No's 1, 2, 3
- 6 x Hexagon 2, 2.5, 3, 4, 5, 6mm, 6 x Star 10, 15, 20, 25, 30, 40
- 5 x Slotted 3, 4, 5, 6, 7mm

### Features

- S2 Chrome Vanadium Bits
- 60mm Magnetic Bit Holder
- Moulded PLastic Case for Bit and Holder Storage



## Franklin 100 pce Combination Bit Set 4100



A comprehensive set of assorted screwdriver bits covering most applications including security fittings

- Flat 3 4 4.5 5 5.5 6 6.5 7 8 mm
- PH0 PH1 PH2 PH3, PZ0 PZ1 PZ2 PZ3
- Hexagon 1.5 2 2.5 3 4 5 5.5 6 8 mm
- 1/16" 5/64" 3/32" 7/64" 1/8" 9/64" 5/32" 3/16" 7/32" 1/4"
- Tamperproof Hexagon 2 2.5 3 4 5 6mm
- Spline M5 M6 M8
- Star and Tamperproof Star for Torx type fasteners T8 T10 T15 T20 T25 T27 T30 T40
- Star Plus for 5 point Tamperproof Torx type fasteners T10 T15 T20 T25 T27 T30 T40
- Square 0 1 2 3 4
- Spanner 4 6 8 10mm
- Torq 6 8 10mm
- Tri Wing 1 2 3 4mm

### Features

- S2 Steel Bits
- Robust storage Case
- 60mm Magnetic bit holder
- 60mm Quick release bit holder



## Abracs 42pce Impact Screwdriver Bit Set ABSD42

Contains a wide range of popular size and head type impact bits and accessories to suit a broad range of applications, with increased endurance, product life and performance.

### Features

- S2 Premium Steel
- 25mm
- PH1, PH1.5, PH2, PH2.5, PH3, PH3.5, PH4
- H3, H4, H5, H6
- Flat 5/32, Flat 3/16, Flat 1/4
- T15, T15.5, T20, T20.5, T25, T25.5, T30
- PZ1, PZ1.5, PZ2, PZ2.5, PZ3, PZ3.5, PZ4

### 50mm

- PH1, PH2, PH3
- PZ1, PZ2, PZ3

### T20

### 90mm

- PH2, PH3
- PZ2, PZ3
- T20

### Bit Holder



## Irwin Bit Holder Impact magnetic screw holder A23501

For magnetising IRWIN® Impact Performance Series™ single- and double-ended power bits

### Features

- Low profile collar which attaches securely to hold fasteners
- Strong rare earth magnet reduces slipping and wobbling
- Easy release design for removing the collar



## Irwin Quick Change Impact Bits Extensions

Compatible with all 1/4" hex shank accessories including insert bits

### Features

- Engineered for maximum durability
- Quick-release system
- Withstands the high torque of impact drivers
- Black oxide finish resists corrosion

Part No.	Description
A23413	6"
A23414	12"
A23502	2.5"



## Irwin 5 pce Impact Insert Bit Sets

- 2 x PZ2 and 2 x PH2, 4 x PH2, 4 x PZ2

All sets come with a Magnetic Screw-Hold Attachment

### Features

- Maximum durability and long life
- Forged bit (vs. milled) for superior fastener fitment
- Heavy-duty, cold-forged, high-grade steel
- Withstands high torque output
- Black oxide finish resists corrosion

Part No.	Description
A23416	2 x PZ2 & 2 x PH2
A23417	4 x PH2
A23418	4 x PZ2



## Franklin 10 pce T Hexagon Wrench 2-10mm 500MM

- 2.0 2.5 3.0 4.0 4.5 5.0 5.5 6.0 8.0 10mm

### Features

- Metric Sizes
- Greater Torque
- Metal storage rack with size markings
- Suitable for wall mounting
- Ergonomic Handles for comfort and grip
- Size marked handles





**Franklin 8 pce Metric Hexagon Key Set on Ring**  
**900MM**

2.2.5 3 4 5 6 8 10mm

**Features**

- Chrome Vanadium Steel
- Roll Marked Size For Easy Identification
- Matt Black Finish



**Franklin 7 pce Ball End Hexagon Keys 2-8mm**  
**BT308**

2.2.5 3 4 5 6 8mm

**Features**

- Folding Hex Key Set
- Chrome Vanadium Steel



**Franklin 8 pce Star Key Set TP8-TP40 for Tamperproof Torx**  
**BT310**

T8 T10 T15 T20 T25 T27 T30 T40

**Features**

- Folding Star Key Set for Tamperproof Torx
- Chrome Vanadium Steel



**Franklin 8 pce Star Key Set on Ring 9-40**  
**TX702**

Sizes - 9 10 15 20 25 27 30 40

**Features**

- Chrome Vanadium Steel
- Roll Marked Size For Easy Identification
- Matt Black Finish



**Franklin 7 pce Hexagon Keys 2-8mm**  
**BT307**

2.2.5 3 4 5 6 8mm

**Features**

- Folding Hex Key Set
- Chrome Vanadium Steel



**Franklin 8 pce Star Key Set T8-T40**  
**BT309**

T8 T10 T15 T20 T25 T27 T30 T40

**Features**

- Folding Star Key Set
- Chrome Vanadium Steel



**Franklin 16 pce Star / Hex T Wrench Set**  
**TP960**

For use on Torx type fasteners

- Long Star x Short Tamperproof Star T10 x 75mm, T15 x 75mm, T20 x 100mm, T25 x 100mm, T30 x 150mm, T40 x 150mm, T45 x 200mm, T50 x 200mm
- Long Ball End Hexagon x Short Hexagon 2.0 x 75mm, 2.5 x 75mm, 3.0 x 100mm, 4.0 x 100mm, 5.0 x 150mm, 6.0 x 150mm, 8.0 x 200mm, 10.0 x 200mm.

**Features**

- T Handled Angle Wrenches made from Chrome Vanadium Steel
- Tough Impact Resistant Carry Case
- Roll marked on shaft and printed on handle for easy identification

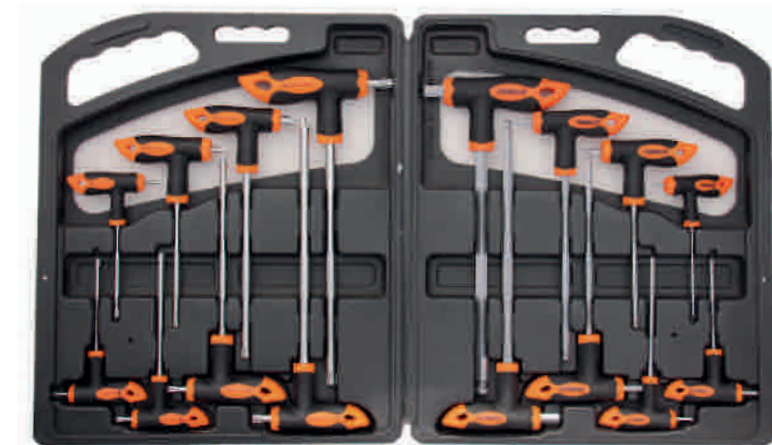

## Franklin 9 pce Star Angle Wrench Set TP980

- T10 X 16 X 88
- T15 X 16 X 100
- T20 X 18 X 110
- T25 X 20 X 125
- T27 X 24 X 140
- T30 X 28 X 160
- T40 X 32 X 180
- T45 X 36 X 200
- T50 X 40 X 217mm

### Features

- S2 Steel
- Extra Long Angle Wrench Set
- Overall Length - 88 - 217mm
- Colour Coded and laser etched to ease size selection
- With Storage Clip



**FRANKLIN**  
Professional Quality Tools



## Wera 9 pce Hexagon Wrench Set V73593

High quality colour coded L-key set with convenient plastic sleeve

- 1 x 1.5x90
- 1 x 2.0x101
- 1 x 2.5x112
- 1 x 3.0x123
- 1 x 4.0x137
- 1 x 5.0x154
- 1 x 6.0x172
- 1 x 8.0x195
- 1 x 10.0x224

### Features

- Hex-Plus allows socket head screws to live longer
- Hexagonal ballpoint on the long arm
- Colour coded according to sizes
- Easy-to-grip plastic sleeve
- BlackLaser surface treatment provides protection against corrosion
- Laser engraved size markings for easy identification



**Wera**  
Werkzeug mit Sinn



## Franklin 9 pce Hexagon Wrench Set TP990

- 1.5
- 2.0
- 2.5
- 3.0
- 4.0
- 5.0
- 6.0
- 8.0
- 10.0mm

### Features

- S2 Steel
- Extra Long Angle Wrench Set
- Long ball end and short hexagon
- Overall Length - 90 - 224mm
- Colour Coded and laser etched to ease size selection
- With storage clip



**FRANKLIN**  
Professional Quality Tools



## Wera 9 pce Tamper Torx Wrench Set V73599

High quality colour coded L-key set with convenient plastic sleeve

- 1 x TX 8x76 (1)
- 1 x TX 9x79 (1)
- 1 x TX 10x85 (2)
- 1 x TX 15x90
- 1 x TX 20x96
- 1 x TX 25x104
- 1 x TX 27x112
- 1 x TX 30x122
- 1 x TX 40x132

- (1) Product without bore hole at the short and without ball-end at the long arm.
- (2) Product without ball-end at the long arm.

### Features

- L-keys for TORX® BO screws to loosen safety connections
- The ballpoint allows offset working
- Colour coded according to sizes
- Easy-to-grip plastic sleeve
- BlackLaser surface treatment provides protection against corrosion
- Magnetising/Demagnetising Storage Clip



**Wera**  
Werkzeug mit Sinn





# Pliers - H

## Contents

Franklin

H2

Irwin Vise-Grip

H4

Irwin Pliers

H12

## GearF™ Pliers

GearF - Franklin Lifetime Warranty  
Supplied in industry approved EVA foam



See Section C

# 2020

[www.franklin-tools.co.uk](http://www.franklin-tools.co.uk)

# GearF™ Pliers

GearF - Franklin Lifetime Warranty  
Supplied in industry approved EVA foam



See Section C

## Franklin 5 way Terminal Crimping Plier 1603

### Cuts and Strips Wire

- 0.75, 1.0, 1.5, 2.5, 4.0, 6.0mm

### Crimps Ignition and Insulated Terminals

- 1.5mm Red, 2.5mm Blue, 6mm Yellow

### Shears Bolts

- M2.6, M3, M3.5, M4, M5

### Features

- Clear Bright markings
- Ergonomic Red Plastic Handles



## Franklin 4 pce Int/Ext Circlip Plier Set 2070

- 175mm Internal and External Straight
- 175mm Internal and External Angled

### Features

- 2mm Precision Ground Tips
- Spring Loaded Handle Assist
- Ergonomic Comfort Grips
- Carbon Steel
- Plastic Dipped Handles For Comfort and Grip
- Supplied in a Roll for Storage Convenience



## Franklin Safety Wire Twisting Plier 1609

A Versatile Plier to Rapidly and Consistently do Reliable Safety Wiring. Used for Safety Wiring Critical Fasteners and Electrical Connectors

### Features

- Can be used One Handed
- Gives a Consistant Twist
- Provides Even Tension
- Black Painted Finish



## Franklin 3 pce Plier Set FP30

- 200mm 8" Combination
- 200mm 8" Long Nose
- 175mm 7" Side Cutter

### Features

- Plier Set with heavy duty PVC grips
- Supplied in a roll for storage convenience
- Drop Forged Alloy Steel
- TUV GS Approved



Part No.	Description
FP301	8" Combination
FP302	8" Long Nose
FP303	7" Side-Cutters

## Franklin 10 pce Int/Ext Circlip Plier Set 2080

8 convertible internal & external circlip pliers with straight and angled tips

- 150mm straight - 1.0mm (0.038") tips
- 150mm angled - 1.0mm (0.038") tips
- 150mm straight - 1.2mm (0.047") tips
- 150mm angled - 1.2mm (0.047") tips
- 190mm straight - 1.8mm (0.070") tips
- 190mm angled - 1.8mm (0.070") tips
- 225mm straight - 2.3mm (0.090") tips
- 225mm angled - 2.3mm (0.090") tips

### Features

- Convertible Circlip Pliers
- Straight and Angled Hooks
- Ergonomic Handles
- Tough Impact Resistant Carry Case





## Franklin 3 pce Water Pump Pliers 10", 12" & 16" FP3S

- 10" (250mm) Water Pump Plier
- 12" (300mm) Water Pump Plier
- 16" (400mm) Water Pump Plier

Part No.	Description
FP16	16"
FP2	10" & 12" 2pce Set

### Features

- Chrome Vanadium Steel
- Hardened and Tempered
- Quick Action Size Adjustment
- Ergonomic Comfort Grips
- Supplied in a Roll For Storage Convenience



## Franklin Butt End Circlip Plier TA92

To Easily Remove or Replace Circlips

### Features

- 225mm (9")
- 19mm Capacity
- Black finish
- Red Dipped Handles for Comfort and Grip



## Irwin Vise-Grip Long Nose

IRWIN® VISE-GRIP® Original locking tools

### Features

- Long Nose - Provides easy access in narrow, hard-to-reach places
- 3X more gripping power
- High grade alloy steel is heat treated for maximum toughness and durability
- Hex Key Adjusting Screw
- Convenient wire cutter



Part No.	Description
A4LN	100mm 4"
A6LN	150mm 6"
A9LN	225mm 9"

## Irwin 3 pce CR Vise-Grip Set A08020

IRWIN® VISE-GRIP® Original locking tools

- A08019 (New 5CR)
- A08018 (New 7CR)
- A08017 (New 10CR)

### Features

- Unique Curved Jaw - Great for securely gripping
- 3X more gripping power
- High grade alloy steel is heat treated for maximum toughness and durability
- Hex Key Adjusting Screw



Part No.	Description
A08019	5" - 125mm
A08018	7" - 175mm
A08017	10" - 250mm

## Irwin Vise-Grip Straight Jaw

IRWIN® VISE-GRIP® Original locking tools

### Features

- Straight Jaw - Great for securely gripping
- High grade alloy steel is heat treated for maximum toughness and durability
- Hex Key Adjusting Screw



Part No.	Description
A7R	175mm - 7"
A10R	250mm - 10"

**Irwin Vise-Grip Curved Jaw with Wire Cutters**

IRWIN® VISE-GRIP® Original locking tools

**Features**

- Unique Curved Jaw - Great for securely gripping
- High grade alloy steel is heat treated for maximum toughness and durability
- Hex Key Adjusting Screw

Part No.	Description
A4WR	100mm 4"
A5WR	125mm 5"
A7WR	175mm 7"
A10WR	250mm 10"



Lifetime Guarantee



**Irwin ViseGrip 'C' Clamp**

IRWIN® VISE-GRIP® Original locking tools

- A6R,A11R,A18R,A24R - Locking C-Clamps Regular Tips
- A18DR - Locking C-Clamps - Deep Throat

**Features**

- Wide-opening jaws and greater throat capacity provides greater versatility in clamping work-pieces
- High grade alloy steel is heat treated for maximum toughness and durability
- Hex Key Adjusting Screw

Part No.	Description
A6R	150mm 6" - 2.125" Jaw Capacity
A11R	275mm 11" - 4" Jaw Capacity
A18R	455mm 18" - 8" Jaw Capacity
A18DR	455mm 18" - 7.5" Jaw Capacity
A24R	600mm 24" - 10" Jaw Capacity



Lifetime Guarantee



**Irwin Vise-Grip 'C' Clamp + Swivel Pad**

IRWIN® VISE-GRIP® Original locking tools

**Features**

- Locking C-Clamps with Swivel Pads
- High grade alloy steel is heat treated for maximum toughness and durability
- Hex Key Adjusting Screw

Part No.	Description
A4SP	100mm 4" - 1.625" Jaw Capacity
A6SP	150mm 6" - 2.125" Jaw Capacity
A11SP	275mm 11" - 4" Jaw Capacity
A18SP	455mm 18" - 8" Jaw Capacity
A24SP	600mm 24" - 10" Jaw Capacity



Lifetime Guarantee



**Irwin Vise-Grip Large Curved Jaw 300mm 12"**

**A12LC**

IRWIN® VISE-GRIP® Original locking tools

**Features**

- The heavy-duty jaws grip all shapes
- Ideal for plumbers, mechanics, welders and large jobs



Lifetime Guarantee





**Irwin 4 pce Vise-Grip Set  
A71**

IRWIN® VISE-GRIP® Original locking tools

- A6LN - Straight Jaw
- A7R - Straight Jaw
- A5WR - Curved Jaw
- A08017 (New 10CR) - Curved Jaw

**Features**

- Straight and Curved Jaws - Great for securely gripping
- High grade alloy steel is heat treated for maximum toughness and durability
- Hex Key Adjusting Screw
- Supplied in a Roll For Storage Convenience



Lifetime Guarantee



**Irwin 3 pce Fast Release Vise-Grip Set  
A76**

Fast Release Locking Pliers have a One-Handed, Triggerless Release Twice as Easy to Open as the Traditional Design

- AT03T - 175mm Fast Release A7R - Straight Jaw
- AT05T - 250mm Fast Release A10WR - Curved Jaw
- AT15T - 225mm Fast Release A9LN - Long, Straight Nose

**Features**

- High Grade Alloy Steel
- Heat Treated for Maximum Toughness and Durability
- Hex Key Adjusting Screw
- Anti-Pinch, Non-Slip Protouch Grips provide comfort and control
- Supplied in a Roll For Storage Convenience



Lifetime Guarantee



**Irwin 3 pce Vise-Grip Set  
A73**

IRWIN® VISE-GRIP® Original locking tools

- A5WR - Curved Jaw
- A10WR - Curved Jaw
- A6LN - Long Nose

**Features**

- Unique Curved Jaw and Long Nose - Great for securely gripping
- High grade alloy steel is heat treated for maximum toughness and durability
- Hex Key Adjusting Screw
- Supplied in a Roll For Storage Convenience



Lifetime Guarantee



**Irwin Vise-Grip Locking Wrenches**

IRWIN® VISE-GRIP® Original locking tools

**Features**

- The jaws of the Locking Wrenches lock on three sides of a bolt
- The locking wrench is adjustable to over 16 wrench sizes
- Built in wire cutter can cut up to a 1/4 inch (63mm) bolt



Part No.	Description
A4LW	4" 7-12mm
A10LW	10" 15-28mm
A7LW	7" 11-19mm

Lifetime Guarantee



**Replacement Vise Grip Spring**

Locking Pliers Spare Parts



Part No.	Description
VS4	4"
VS5	5"
VS7	7"
VS10	10"

Lifetime Guarantee



**Irwin Clamps**

IRWIN® VISE-GRIP® Original locking tools

**Features**

- Unique Jaw Designs - Great for working sheet metal, keeping weld areas visible and quick clamping of panels
- High grade alloy steel is heat treated for maximum toughness and durability
- Hex Key Adjusting Screw

Part No.	Description
A8R	Sheet Metal Clamp 9"
A9R	Welding Clamp 9"
A9AC	Panel Clamp 9"
A20R	Chain Clamp 18"



Lifetime Guarantee



**Irwin 2 pce Fast Release Vise-Grip Set AT214**

Fast Release Locking Pliers have a One-Handed, Triggerless Release Twice as Easy to Open as the Traditional Design

- AT05T - 250mm Fast Release A10WR - Curved Jaw
- AT07T - 175mm Fast Release A7WR - Curved Jaw

**Features**

- High Grade Alloy Steel
- Heat Treated for Maximum Toughness and Durability
- Hex Key Adjusting Screw
- Anti-Pinch, Non-Slip Protouch Grips provide comfort and control



Lifetime Guarantee



**Irwin Fast Release Vise Grips**

Fast Release Locking Pliers have a One-Handed, Triggerless Release. Twice as Easy to Open as the Traditional Design

**Features**

- High Grade Alloy Steel
- Heat Treated for Maximum Toughness and Durability
- Hex Key Adjusting Screw
- Anti-Pinch, Non-Slip Protouch Grips provide comfort and control

Part No.	Description
AT01T	10R 10"/250mm Straight Jaw
AT03T	7R 7"/175mm Straight Jaw
AT05T	10WR 10"/250mm Curved Jaw with Wire Cutter
AT07T	7WR 7"/175mm Curved Jaw with Wire Cutter
AT09T	5WR 5"/125mm Curved Jaw
AT14T	6LN 6"/150mm Long Nose
AT15T	9LN 9"/225mm Long Nose
A07189	11R 11"/275mm C Clamp



Lifetime Guarantee



**Irwin Quick Adjustable Pipe Wrench 58mm A03642**

Lightweight Multi-Purpose Pipe Wrench Suitable for One Handed Operation

**Features**

- High Carbon Steel Upper Jaw for Strength
- Hardened Serrated Steel Jaw Teeth
- Lightweight but Strong Aluminium Sliding Body
- Quick Release Trigger
- For Hard to Reach Areas
- 58mm Jaw Capacity
- Ideal for Pipe Diameters up to 1-1/2" (38mm)
- Ergonomic Handle is Ideal for Heavy Torque and Maximum Comfort
- Length: 288mm (11 1/2 in)
- Weight: 550g



Lifetime Guarantee





**Irwin 3 pce Plier Set**  
**A05483**

IRWIN® VISE-GRIP® Traditional Pliers

- A05493 - 6" Side Cutters
- A05504 - 8" Long Nose
- A05877 - 7" Combination

**Features**

- Induction Hardened Cutting Edges Designed to Stay Sharper Longer
- Machined Jaws for Maximum Gripping
- Moulded ProTouch™ Grips for Added Comfort and Less Hand Fatigue
- TÜV/GS Approvals



Lifetime Guarantee



**Irwin 8" Long Nose Pliers**  
**A05504**

Thin Nose Profile gets into Tight Spaces and is Easier to Reach Around Obstructions

**Features**

- Induction Hardened Cutting Edges which Stay Sharp Longer
- Machined Jaws for Maximum Gripping Strength
- Moulded ProTouch™ Grips for Added Comfort and Less Hand Fatigue
- TÜV/GS Approved



Lifetime Guarantee



**Irwin End Cutter Pliers**  
**A05517**

Cuts upto 2.0 mm diameter cables

**Features**

- Manufactured from Chromium Nickel Steel that Allows for Improved Durability on the Gripping and Cutting Face
- Induction Hardened Cutting Edges which Stay Sharp Longer
- Machined Jaws for Maximum Gripping Strength
- Moulded ProTouch™ Grips for Added Comfort and Less Hand Fatigue
- TÜV/GS Approved



Lifetime Guarantee



**Irwin Side Cutting Pliers**

IRWIN® VISE-GRIP® Traditional Pliers

**Features**

- Induction Hardened Cutting Edges Designed to Stay Sharper Longer
- Machined Jaws for Maximum Gripping
- Moulded ProTouch™ Grips for Added Comfort and Less Hand Fatigue
- TÜV/GS Approved

Part No.	Description
A05493	6" 150mm
A05494	7" 170mm
A05495	8" 200mm



Lifetime Guarantee



**Irwin 8" Bent Nose Pliers**

**A05506**

Thin, angled nose profile gets into tight spaces and is easier to reach around obstructions

**Features**

- Induction Hardened Cutting Edges which Stay Sharp Longer
- Machined Jaws for Maximum Gripping Strength
- Moulded ProTouch™ Grips for Added Comfort and Less Hand Fatigue
- TÜV/GS Approved



Lifetime Guarantee



**Irwin 8" Cable Cutter Pliers**

**A05518**

Can Cut upto 5.0 mm Diameter Thickness Cables

**Features**

- Manufactured from Chromium Nickel Steel that Allows for Improved Durability on the Gripping and Cutting Face
- Induction Hardened Cutting Edges which Stay Sharp Longer
- Machined Jaws for Maximum Gripping Strength
- Moulded ProTouch™ Grips for Added Comfort and Less Hand Fatigue
- TÜV/GS Approved



Lifetime Guarantee



## Irwin 8" Combination Pliers A05876

Muti-Purpose Pliers combining gripping jaws with wire cutters

- Features**
- Multi-Grip Jaws With maximum gripping groove design
  - Cuts Upto 1.6mm cables
  - Manufactured from Chromium Nickel Steel
  - Induction Hardened Cutting Edges which Stay Sharp Longer
  - Machined Jaws for Maximum Gripping Strength
  - Moulded ProTouch™ Grips for Added Comfort and Less Hand Fatigue
  - TÜV/GS Approved



Lifetime Guarantee



## Irwin Groove Lock Pliers

GrooveLock Pliers are Designed with Twice the Number of Groove Positions as Traditional Groove Joint Pliers to Deliver Optimal Hand and Jaw Positioning

- Features**
- All Purpose Jaw Grips onto flat, Round, Hex and Square work pieces
  - Press-n-Slide Button Adjusts Jaws Faster than Traditional Groove Joint Pliers
  - Multi-Groove Ratcheting System For Precise Positioning on Any Type of Work Surface
  - Anti-Pinch Non-Slip ProTouch Grips Provide comfort, control and less hand fatigue



Part No.	Description
A78116	16"
A78120	20"

Lifetime Guarantee



## Irwin Vise-Grip Quick-Grip XP OHBC A05943

Ideal for Heavy-Duty Applications Such as Installation, Demolition etc.

- Features**
- Evenly Distributes up to 272kg (600 lbs.) of Sustained Clamping Pressure
  - Quick-Change™ Button Provides Easy Removal of Jaws for Accessory Installation or conversion to a spreader
  - Removable Swivel Jaws and Non-Marring Pads deliver even distribution of clamping force
  - One-Handed Quick-Release Trigger
  - Heat-Treated, Black Oxide Carbon Steel I-Beam Provides Less Bend and Flex for Superior Durability
  - Adjustable Foot Provides added support



Lifetime Guarantee



## Irwin Groovelock Water Pump Plier A35097

GrooveLock Pliers are Designed with Twice the Number of Groove Positions as Traditional Groove Joint Pliers to Deliver Optimal Hand and Jaw Positioning

- Features**
- Smooth Jaw 250mm - 10"
  - Press-n-Slide Button Adjusts Jaws Faster than Traditional Groove Joint Pliers
  - Multi-Groove Ratcheting System For Precise Positioning on Any Type of Work Surface
  - Anti-Pinch Non-Slip ProTouch Grips Provide comfort, control and less hand fatigue



Lifetime Guarantee



## Irwin VDE Pliers Irwin 3 pce VDE Plier Set 1000v A05519

Chrome Nickel Steel Machined Jaws provide maximum grip

- Features**
- IRWIN® Vise-Grip® VDE Pliers are Fully TÜV, GS and VDE Certified
  - Guaranteed Safe for Working with Electrical Equipment up to AC 1000V or DC 1500V
  - Induction Hardened Cutting Edges Stay Sharp Longer
  - Machined Jaws Designed for Maximum Gripping Strength
  - ProTouch™ Grips Provide Extra Comfort for Less Hand Fatigue



Lifetime Guarantee



Part No.	Description
A05865	Diagonal 150mm
A05869	Long Nose 200mm
A05873	Combination 175mm
A05871	Wire Strippers 150mm Additional Plier

## Irwin Groovelock Water Pump Pliers

GrooveLock Pliers are Designed with Twice the Number of Groove Positions as Traditional Groove Joint Pliers to Deliver Optimal Hand and Jaw Positioning

- Features**
- All Purpose Jaw Grips onto flat, Round, Hex and Square work pieces
  - Press-n-Slide Button Adjusts Jaws Faster than Traditional Groove Joint Pliers
  - Multi-Groove Ratcheting System For Precise Positioning on Any Type of Work Surface
  - Anti-Pinch Non-Slip ProTouch Grips Provide comfort, control and less hand fatigue

Part No.	Description
A07627	200mm - 8"
A07628	250mm - 10"
A07629	300mm - 12"



Lifetime Guarantee





## Irwin 8" Performance Diagonal Pliers A50504

For Cutting ACSR, Nails, Screws, Piano Wire etc

### Features

- PowerSlot\* Technology Provides More Power to Halve the Cutting Effort
- Induction Hardened Cutting Edges which Stay Sharp Longer
- Three-Zone Comfort Grips are Contoured for Optimal Cushion and Control
- Integrated Handle Hook System for Safer use at Elevated Working Conditions
- Specially Coated for Superior Rust-Resistance and Longer Tool Life



Lifetime  
Guarantee

IRWIN  
Industrial Tools

## Irwin 8" Ergo Performance Long Nose Pliers A50508

62° Ergonomic Angled Head for Reduced Wrist Strain

### Features

- Wire Stripper and Wire Crimper Features
- PowerSlot\* Technology Provides More Power to Halve the Cutting Effort
- Induction Hardened Cutting Edges which Stay Sharp Longer
- Three-Zone Comfort Grips are Contoured for Optimal Cushion and Control
- Integrated Handle Hook System for Safer use at Elevated Working Conditions
- Specially Coated for Superior Rust-Resistance and Longer Tool Life



Lifetime  
Guarantee

IRWIN  
Industrial Tools

## Irwin 8" Performance Long Nose Pliers A50507

Thin nose profile gets into tight spaces

### Features

- PowerSlot\* Technology Provides More Power to Halve the Cutting Effort
- Induction Hardened Cutting Edges which Stay Sharp Longer
- Three-Zone Comfort Grips are Contoured for Optimal Cushion and Control
- Integrated Handle Hook System for Safer use at Elevated Working Conditions
- Specially Coated for Superior Rust-Resistance and Longer Tool Life
- Built-In Spanner for Turning Screws, Nuts and Grounding Rods



Lifetime  
Guarantee

IRWIN  
Industrial Tools

## Irwin 8" Performance End Cutting Pliers A50510

For Cutting ACSR, Nails, Screws, Piano Wire etc

### Features

- PowerSlot\* Technology Provides More Power to Halve the Cutting Effort
- Induction Hardened Cutting Edges which Stay Sharp Longer
- Three-Zone Comfort Grips are Contoured for Optimal Cushion and Control
- Integrated Handle Hook System for Safer use at Elevated Working Conditions
- Specially Coated for Superior Rust-Resistance and Longer Tool Life



Lifetime  
Guarantee

IRWIN  
Industrial Tools

# Metal Working - I

## Contents

Drills	I2
Rotary Tools	I6
Hand Brushes	I7
Rotary Brushes	I9
Multi-Packs	I10
Cutting Discs	I13
Riveters	I14
Saws	I15
Snips	I17
Files	I18
Vices	I19
Taps & Dies	I20

2020

[www.franklin-tools.co.uk](http://www.franklin-tools.co.uk)





## Franklin 19 pce HSS-CO Cobalt Drill Set CD19

1 1.5 2 2.5 3 3.5 4 4.5 5 5.5 6 6.5 7 7.5 8 8.5 9 9.5 10mm  
Designed for High Performance Drilling of Sheet Steel

### Features

- 135° Point Ensures Perfect Centring and Accurate Drilling Without need of a Guide Dot to Follow
- High performance HSSCo Steel Jobber Drills for use on Alloys, Stainless, High Carbon and Hardened Steels
- Manufactured to DIN338 Using 4.5-5% Cobalt M35 Steel

• Comes in a Tough Metal Drill Box  
\*\*\* Please See Specifications Sheet on the Website Download Tab for Recommended Minimum and Maximum Drilling Speeds for Drill Bit Size on Specific Materials \*\*\*

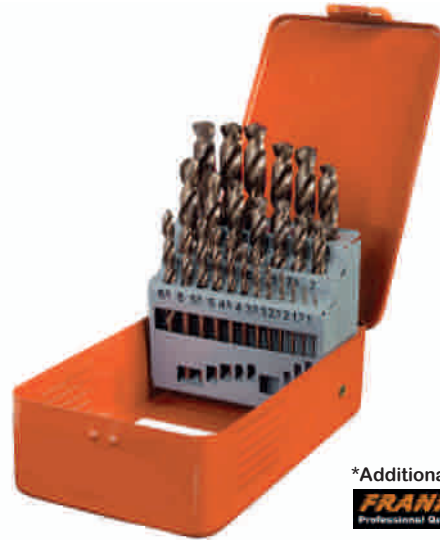

\*Additional Size  
**FRANKLIN**  
Professional Quality Tools

Part No.	Description
CD010	1.0mm
CD015	1.5mm
CD020	2.0mm
CD025	2.5mm
CD030	3.0mm
CD035	3.5mm
CD040	4.0mm
CD045	4.5mm
CD050	5.0mm
CD055	5.5mm
CD060	6.0mm
CD065	6.5mm
CD070	7.0mm
CD075	7.5mm
CD080	8.0mm
CD085	8.5mm
CD090	9.0mm
CD095	9.5mm
CD100	10.0mm
CD105	10.5mm*
CD110	11.0mm*
CD120	12.0mm*
CD130	13.0mm*



**BEST BUY**  
**PRACTICAL**  
**CLASSICS**

## HSS Jobber Drills - Metric

The New Drill Bit Design Combines Toughness and Precision with Excellent Cutting Efficiency for Drilling Alloyed, Carbon and Plain Steel  
Available in boxes of 10 up to and including 10mm. Available in boxes of 5 for any size above 10mm.

### Features

- Break resistant with high elasticity and toughness.
- Special point shape for speed.
- Long life due to high quality HSS Steel

For full list of drill sizes and specifications. Please refer to the table available on the download tab on our website.

\*\*\* Please note - There may be a crossover of drill pattern for certain sizes whilst existing stock is still available. Performance of drill will not be diminished however \*\*\*



**FRANKLIN**  
Professional Quality Tools

Part No.	Description
30M	1mm
31M	1.5mm
32M	2mm
33M	2.2mm
34M	2.5mm
35M	3mm
36M	3.3mm
37M	3.5mm
38M	4mm
39M	4.2mm
40M	4.5mm
41M	5mm
42M	5.5mm
43M	6mm
44M	6.5mm
45M	7mm
46M	7.5mm
47M	8mm
48M	8.5mm
49M	9mm
50M	9.5mm
51M	10mm
52M	10.5mm
53M	11mm
54M	11.5mm
55M	12mm
56M	12.5mm
57M	13mm

## HSS Jobber Drills - Imperial

The New Drill Bit Design Combines Toughness and Precision with Excellent Cutting Efficiency for Drilling Alloyed, Carbon and Plain Steel  
Available in boxes of 10 up to and including 25/64". Available in boxes of 5 for any size above 25/64".

### Features

- Break resistant with high elasticity and toughness.
- Special point shape for speed.
- Long life due to high quality HSS Steel

For full list of drill sizes and specifications. Please refer to the table available on the download tab on our website.

\*\*\* Please note - There may be a crossover of drill pattern for certain sizes whilst existing stock is still available. Performance of drill will not be diminished however \*\*\*



**FRANKLIN**  
Professional Quality Tools

Part No.	Description
60F	1/16"
61F	5/64"
62F	3/32"
63F	7/64"
64F	1/8"
65F	9/64"
66F	5/32"
67F	11/64"
68F	3/16"
69F	13/64"
70F	7/32"
71F	15/64"
72F	1/4"
73F	17/64"
74F	9/32"
75F	19/64"
76F	5/16"
77F	21/64"
78F	11/32"
79F	23/64"
80F	3/8"
81F	25/64"
82F	13/32"
83F	27/64"
84F	7/16"
85F	29/64"
86F	15/32"
87F	31/64"
88F	1/2"

## Irwin Turbomax HSS Drills

Designed Primarily for High Performance Drilling in Sheet Metal

### Features

- Can Also be used on all types of wood and plastic
- Suitable for drilling stainless steel
- Remember to always use a coolant when drilling stainless steel

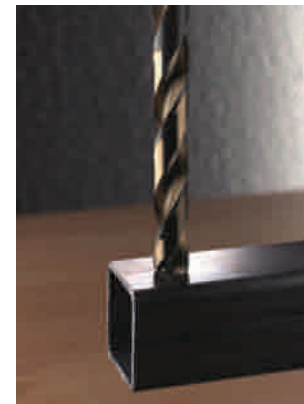

**IRWIN**  
Industrial Tools

Part No.	Description
A02202	1.0mm (2)
A02203	1.5mm (2)
A02204	2.0mm (2)
A02205	2.5mm (2)
A02206	3.0mm
A02210	3.5mm
A02211	4.0mm
A02215	4.5mm
A02218	5.0mm
A02220	5.5mm
A02221	6.0mm
A02222	6.5mm
A02223	7.0mm
A02224	7.5mm
A02225	8.0mm
A02226	8.5mm
A02227	9.0mm
A02228	9.5mm
A02229	10.0mm
A02230	11.0mm
A02231	12.0mm
A02232	13.0mm

**Irwin 19 pce Turbomax HSS Drill Set  
A02233**

1 1.5 2 2.5 3 3.5 4 4.5 5 5.5 6 6.5 7 7.5 8 8.5 9 9.5 10mm  
Designed Primarily for High Performance Drilling in Sheet Metal

- Features**
- Can Also be used on all types of wood and plastic
  - Suitable for drilling stainless steel
  - Remember to always use a coolant when drilling stainless steel
  - Tough Impact Resistant Case



**Irwin 15 pce TiN Pro HSS Drill Set  
A03991**

1.5 2 2.5 3 3.5 4 4.5 5 5.5 6 6.5 7 8 9 10mm  
Designed for High Performance Drilling of Sheet Steel

- Features**
- 135° Split Point Grinding Ensures Perfect Centring and Reduced Drilling Pressure
  - Titanium Nitride Coating Reduces Friction and Resists Wear
  - Increased Drill Speeds of 40-60% Compared to Traditional Bits
  - Tough Impact Resistant Case



**Irwin 15 pce HS Cobalt Pro Drill Set  
A03990**

1.5 2 2.5 3 3.5 4 4.5 5 5.5 6 6.5 7 8 9 10mm  
Perfect for Drilling Stainless Steel

- Features**
- 135° Split Point Grinding Ensures Perfect Centring and Reduced Drilling Pressure
  - High Heat Resistance and Improved Wear Resistance
  - 5% Cobalt
  - Tough Impact Resistant Case



**Irwin 15 pce Turbomax HSS Drill Set  
A03992**

1 1.5 2 2.5 3 3.5 4 4.5 5 5.5 6 6.5 7 8 9 10mm  
Designed Primarily for High Performance Drilling in Sheet Metal

- Features**
- Can Also be used on all types of wood and plastic
  - Suitable for drilling stainless steel
  - Remember to always use a coolant when drilling stainless steel



**Irwin Unibit Step Drills**

Designed for High Performance Drilling of Sheet Steel. Unique Flute Design Ensures Perfect Round Holes in Sheet Metal.

- Features**
- Single Flute for Maximum Drilling Control into Sheet Metal
  - Self-Centring Point - Eliminates Centre Punching
  - Made From Industrial Grade M7 High Speed Steel
  - Flatted Shank Prevents the Drill Bit from Slipping in the Chuck

Part No.	Description
AU1M	4mm-12mm 9 sizes 1/4"
AU4M	4mm-22mm 10 sizes 3/8"
AU5M	5mm-35mm 13 sizes 1/2"



**Abracs 3pce Step Drill Set  
ASDK3**

For use on Metal, Sheet Metal, Steel and Stainless Steel

- Features**
- 1 x 4-12mm (1mm increments) x 6mm Shank
  - 1 x 4-20mm (2mm increments) x 8mm Shank
  - 1 x 6-30mm (2mm increments) x 10mm Shank
  - 3 edged shank to eliminate slipping
  - Dual cutting edges
  - Sturdy plastic storage case



**19 pce Milwaukee HSS Drill Set  
M52468**

1 1.5 2 2.5 3 3.5 4 4.5 5 5.5 6 6.5 7 7.5 8 8.5 9 9.5 10mm  
Suitable for Drilling Steel, Cast Iron, Alloyed and Non-Alloyed Material

- Features**
- High Speed Steel Rollforged Metal Drill Bits
  - Produced According to DIN 338
  - Oxide Coating Enables Quick Swarf Removal
  - Normal Point Shaped Cutting Tip with 118° Angle
  - Type N Flute Normal Angle
  - Comes in a Tough Metal Drill Box



**Franklin Tapered Hand Reamer  
TA627**

Reams, Deburrs, Aligns and Enlarges Holes

- Features**
- 4 - 22mm Diameter
  - Heat Treated Tool Steel

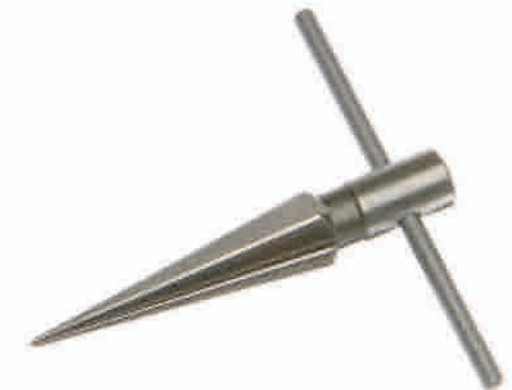



## Franklin Wire Cup Brush 50mm 9168D

Ideal for General Cleaning and Deburring Applications

### Features

- For use on metal, rust and paint
- Mounted on a 6mm Shank
- Max 4,500 rpm



## Franklin Wire Cup Brush 65mm 9268D

Ideal for General Cleaning and Deburring Applications

### Features

- For use on metal, rust and paint
- Mounted on a 6mm Shank
- Max 5,000 rpm



## Franklin 2 pce De-Coke Brush Set 9251D

For Removing Carbon Deposits

### Features

- Use with a Variable Speed Drill
- Mounted on a 6mm shank
- Max 6000 rpm



## Franklin 3 pce Rotary Burr Set 10mm Head AB1003

Tungsten Carbide Rotary Burr Set

### Features

- 10mm diameter heads with 6mm diameter shanks x 65mm long
- Ball nose
- Pointed tree nose
- Cylindrical with front cut
- No 6 Universal cut for carbon, stainless alloy and cast steels - weld seams etc
- Not suitable for aluminium, brass, copper, zinc or plastic materials



## Solid Carbide Rotary Burrs

Ideal for the Tool and Mould Industry

### Features

- Tungsten Carbide Rotary Burr
- Cut 6 - Universal profile suitable for hard materials and welding seams
- 6mm Shank

### AB08NF

- 8mm x 65mm - Cylindrical without Front Cut

### AB10BN

- 10mm x 65mm - Ball Nose

### AB10CB

- 10mm x 65mm - Conical Round Nose

### AB10FC

- 10mm x 65mm - Cylindrical with Front Cut

### AB10OV

- 10mm x 61mm - Oval

### AB10PN

- 10mm x 65mm - Arc Pointed Nose

### AB10RN

- 10mm x 65mm - Arc Round Nose



Part No.	Description
AB08NF	Cylindrical NFC
AB10BN	10mm Ball Nose
AB10CB	10mm Conical Ball Nose
AB10FC	10mm Cylindrical Front Cut
AB10OV	10mm Oval Nose
AB10PN	10mm Pointed Tree Nose
AB10RN	10mm Round Nose

## Franklin Wire Brushes - Hand

Industrial Quality Hand Brushes Suitable for a Multitude of Cleaning Applications

40/A2 - 2 Rows

40/A3 - 3 Rows

40/A4 - 4 Rows

84/6 - 6 Rows and Scraper

A Heavy Duty Scratch Brush Fixed with a Sturdy Metal Scraper for more Aggressive Applications

### Features

- Suitable on Metal, Concrete, Rust and Paint

Part No.	Description
40/A2	2 Row
40/A3	3 Row
40/A4	4 Row
84/6	6 Row + Scraper



## Abracs 3pce Handled Brush Set ABSCRA

The Curved shape and Narrow Face allow for high pressure cleaning. For use on Metal, Stainless Steel and Paint

### Features

- 1 x General Purpose Brass Dipped Scratch Brush
- 1 x Stainless Steel Scratch Brush
- 1 x Nylon Scratch Brush

Part No.	Description
417	Nylon Blue Handle
418	Brass Dipped Red Handle
419	Stainless Green Handle



**Abracs 4 Row Plastic Handled Wire Brush ABPHBS**

For use on Metal, Concrete, Stainless Steel and Paint

**Features**

- Premium quality wire
- Ergonomic plastic handles



**Franklin Twisted Knot Brush 100mm Bevel 9204**

Twisted Knot Brush 100mm Bevel

**Features**

- M14 x 2mm - For use in popular angle grinders
- Clean / de-burr or remove rust / paint / underseal without damaging the underlying metal surface
- MAXIMUM 12500 RPM



**Franklin Twisted Knot Brush - 65mm Cup 9265**

65mm Twisted Knot Cup Brush

**Features**

- M14 x 2mm - For use in popular angle grinders
- Clean / de-burr or remove rust / paint / underseal without damaging the underlying metal surface
- MAXIMUM 12500 RPM



**Franklin Wire Wheel Brush 75mm 9548D**

75mm Wire Wheel Brush

**Features**

- 6mm shank - For use with a Vari-Speed Drill
- Clean / de-burr or remove rust / paint / underseal without damaging the underlying metal surface
- MAXIMUM 6000 RPM



**Franklin Twisted Knot Brush 100mm Cup 9200**

100mm Twisted Knot Cup Brush

**Features**

- M14 x 2mm - For use in popular angle grinders
- Clean / de-burr or remove rust / paint / underseal without damaging the underlying metal surface
- MAXIMUM 8500 RPM



**Franklin Twisted Knot Brush - 75mm Flat 9206**

Twisted Knot Brush 75mm Flat

**Features**

- 6mm Shank
- Clean / de-burr or remove rust / paint / underseal without damaging the underlying metal surface
- MAXIMUM 15000 RPM



**Abracs 150 x 20mm Wire Wheel AB1502**

For use on Metal, Rust and Paint

**Features**

- High resistance Steel wire
- 6000 Max RPM
- 0.5mm Wire gauge
- Bore reducing bushes 32 - 13mm
- Adaptable to virtually all grinders



**Abracs Zirconium Flap Discs**

Premium Quality Zirconium Flap Discs are Engineered for Maximum Performance Stock Removal, Blending and Finishing

**Features**

- Lightweight Fiberglass Backing
- Strong and Durable
- Suitable for a Full Range of Metal Applications
- For use on Stainless Steel, Sheet Metal, Mild Steel and High Grade Steel
- Packs of 10
- Manufactured to O.S.A. Safety Standards

Part No.	Description
ABF540	115 mm x 40 grit (10)
ABF560	115 mm x 60 grit (10)
ABF580	115 mm x 80 grit (10)





**Abracs 4pce Wire Brush Pack**  
**ABSM1**

For use on Metal, Rust and Paint

**Features**

- 1 x 75mm Circular Brush
- 1 x 50mm Cup Brush
- 1 x 20mm End Brush
- 1 x General Purpose Scratch Brush



**Abracs 10pce Quick Change Accessory Kit**  
**ABSM2**

For use on assorted applications

**Features**

- 1 x 75mm Buffing Wheel, 1 x Polish Block
- 1 x 75mm Circular Brush, 1 x 50mm Cup Brush
- 1 x 25mm End Brush, 1 x 40mm Flap Wheel
- 1 x 55mm Poly Disc, 2 x Mounted Points
- 1 x Quick Change adaptor



**Abracs 7pce Buffing and Polishing Set**  
**ABSM4**

For a wide range of Buffing and Polishing applications

**Features**

- 1 x 100mm Buffing Wheel, 1 x 100mm Felt Wheel
- 1 x 100mm Non-Woven Wheel, 1 x Sponge Block
- 2 x Polish Blocks, 1 x Drive Arbour



**Abracs 10pce Mounted Point Pack**  
**ABSM6**

Containing some of the most popular shapes and sizes for precision metal working

**Features**

- 6mm Spindle



**Abracs 6pce Spindle Mounted Brush Set**  
**ABSM1**

Comprehensive range of spindle mounted brushes for general purpose applications

**Features**

- 6mm Spindle, 2 x 40mm Circular Brush
- 1 x 50mm Circular Brush, 1 x 60mm Circular Brush
- 1 x 75mm Circular Brush, 1 x 50mm Cup Brush



**Abracs 12pce Multi-Accessory Kit**  
**ABSM3**

For use on assorted applications

**Features**

- 1 x 50mm Cup Brush, 1 x 75mm Circular Brush
- 1 x 25mm End Brush, 1 x Spark Plug Brush
- 3 x Mounted Points (mixed sizes)
- 3 x Felt Points (mixed sizes), 2 x Spirabands



**Abracs 7pce 75mm Quick Lock Surface Conditioning**  
**ABSM5**

For use on Stainless Steel, Aluminium, Mild Steel and Plastics

**Features**

- 3 x 75mm Fibre Discs with Quick-Lock fitting
- 3 x 75mm Polirico Discs with Quick-Lock fitting
- 1 x 75mm Quick-Lock Backing Pad



**Abracs 3pce Precision Brush Pack**  
**ABSM7**

For use on Stainless Steel, Metal and Paint  
Ideal for small, precise applications such as cleaning spark plugs or other small engine components

**Features**

- 1 x Brass Brush, 1 x Nylon Brush
- 1 x Stainless Steel Brush
- Ergonomically designed handles



**Abracs 88mm Eraser Wheel**  
**ABEW88**

For use on Decals, Stickers, Stripes and Adhesives

**Features**

- 6mm Spindle



**Abracs 115mm Black Poly Discs**  
**ABF5PB**

Poly Discs have a Unique Structure and Synthetic Resin Coating which Enables the Effective Removal of Rust, Paint, Thermal Blueing and other Contaminants

**Features**

- Lightweight Fiberglass Backing
- Strong and Durable
- Suitable for a Wide Range of Materials
- For use on Metal, Concrete, Stainless Steel and Aluminium
- Minimal Risk of Scratching the Work Piece
- For use on Angle Grinders



**Abracs 25 pce Quick Lock Pack**  
**ABP25**

Ideal Starter Pack of a Selection of 50mm Quick-Lock Products

- 2 x Backing Pad Adaptors
- 7 x Polirico Discs (2 x Coarse 3 x Medium 2 x Fine)
- 9 x Zirconium Sanding Discs (3 x Coarse 3 x Medium 3 x Fine)
- 3 x Poly Discs
- 4 x Zirconium Flap Discs (1 x 40, 60, 80 and 120 Grit)

**Features**

- For use on Stainless Steel, Mild Steel, Aluminium and Plastic
- Simple Twist-On, Twist-Off Fitting System
- Can be used for Cleaning, Stripping, Polishing and Finishing
- Quick, Safe and Easy Fitting
- Ideal for use in the Automotive Industry
- Supplied in Plastic Storage Case



**Abracs Cutting Discs 75mm**  
**APT75F**

Developed for Precision Cutting with Strengthened Core Stability for Reduced Vibration

- 75mm diameter x 1mm x 10mm bore

**Features**

- For use with APT719
- Fast and Precise Cutting with Minimal Effort
- Contain No Iron, Sulphur or Chlorine
- Extra Thin Cutting Discs Produced to O.S.A. Safety Standards
- Pack of 10
- For use on Stainless Steel, Sheet Metal, Mild Steel and High Grade Steel

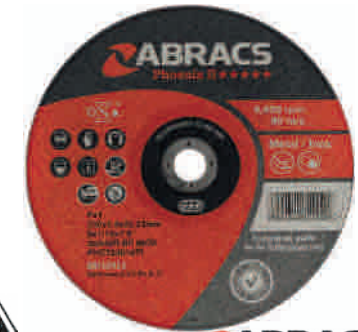

**Abracs 3pce 50 x 20mm Flap Wheel Pack**  
**ABP350**

Ideal for Deburring and General Cleaning

**Features**

- 1 x 50 x 20mm x 40g
- 1 x 50 x 20mm x 80g
- 1 x 50 x 20mm x 120g
- 6mm Spindle
- Max RPM - 10,000



**Abracs 3pce 30 x 20mm Flap Wheel Pack**  
**ABP330**

Ideal for Deburring and General Cleaning

**Features**

- 1 x 30 x 20mm x 40g
- 1 x 30 x 20mm x 80g
- 1 x 30 x 20mm x 120g
- 6mm Spindle
- Max RPM - 16,500



**Abracs Cutting Discs**

Professional Quality Performance Cutting Discs

**Features**

- For use on a Variety of Metal and Stone Applications
- Significant Product Lifespan, Performance and Quality
- Packs of 10
- For use on Mild Steel, Iron, Sheet Steel and High Grade Steel
- Manufactured to European Safety Standard EN12413

Part No.	Description
APF51	115 X 1 mm (10)
APF53	115 x 3 mm (10)
APF56	115 x 6mm (10)



**PCL 3" Buffing Accessory Pack**  
**APA92**

Buffing Accessory Pack Contains Two Different Grades of Sponge Pad, a Lambswool Pad and a 3" Backing Pad

**Features**

- Velcro Backing Pad Allows Simple Removal and Attachment of Buffing Pads
- High Grade Sponge and Lambswool Pads for Efficient Buffing
- Felt Backed Buffing Pads for Easy Transfer to Backing Pad





**PCL Mini 2" Backing Pad**  
**APA93**

The Velcro Backing Pad is Ideal for Quick Transfer of Sanding Discs

**Features**

- For use with the APT902 Sander
- For use with Velcro Sanding Discs
- 2" Diameter
- Hardened composite body material
- M6 Thread
- High Grade Velcro



**PCL 50 Mixed 2" Sanding Discs & Backing Pad**  
**APA95**

This 2" Sanding Accessory Pack supplies 5 grades and are designed to fit Velcro 2" backing pads

**Features**

- 10 X 60 Grade
  - 10 X 120 Grade
  - 10 X 240 Grade
  - 10 X 320 Grade
  - 10 X 400 Grade
- Features**
- Felt sides for easy fit to the backing pad
  - High grade sandpaper pads for a professional finish
  - 5 different grades to cover all situations
  - 2" backing pad also included



**PCL Mini 3" Backing Pad**  
**APA94**

The Velcro Backing Pad is Ideal for Quick Transfer of Sanding Discs

**Features**

- For use with the APT902 Sander
- For use with Velcro Sanding Discs
- 3" Diameter
- Hardened composite body material
- M6 Thread
- High Grade Velcro



**Franklin Hand Riveter Heavy Duty**  
**TA745**

Includes Nozzles for 3/32" 1/8" 5/32" 3/16" Head Diameter Rivets

**Features**

- Plastic Handles for Comfort and Grip
- Spanner



**Franklin Hand Riveter Heavy Duty**  
**TA7450**

Includes Nozzles for 1/8" 5/32" 3/16" 1/4" Head Diameter Rivets

**Features**

- Aluminium Alloy Body
- Alloy Steel Jaws - 325mm long
- Collection Bowl for Sheared Rivet Stems
- Ergonomic Handles for Comfort and Grip
- Spanner



**Irwin Pro BiMetal Jab Saw**  
**A04408**

250mm Blade

**Features**

- Ergonomic handle for secure and comfortable cutting
- Optimised for working in confined spaces



**Irwin Pro BiMetal Hacksaw**  
**A04407**

The heavy-duty hacksaw frame is able to reach over 125kg (25,000 PSI) blade tension to ensure accurate cutting

**Features**

- The soft-touch handle gives a solid and slip-free grip
- Higher Blade Tension For straight cuts and prevents blade being released when dropped
- Metal Tensioning Mechanism For a longer lasting tool
- Built-In Blade Storage So spare blades are easily accessible
- 55° - 90° Blade Mounting
- For sawing large objects



**Irwin Junior Hacksaw**  
**A04409**

Durable Metal Frame and Easy Tensioning Mechanism Allows for Higher Blade Tension and Improved Cutting

**Features**

- The ergonomic handle delivers comfortable sawing



**Irwin BiMetal Hacksaw Blade (100)**  
**A04521**

High-Quality Hacksaw Blades Provide Improved Cutting Performance

**Features**

- 300mm (12") x 24T x 100 Blades
- Tooth Geometry Delivers Higher Resistance Against Tooth Strippage
- Increased Longevity and Durability
- Faster, Smoother and Less Tiring Cutting



**Irwin Junior Hacksaw Blade 150mm 6" x 32T (10)**  
**A04531**

High-Quality Hacksaw Blades Provide Improved Cutting Performance

**Features**

- 150mm (6") x 32T x 10 Blades
- Tooth Geometry Delivers Higher Resistance Against Tooth Strippage
- Increased Longevity and Durability
- Faster, Smoother and Less Tiring Cutting



**Franklin Bi-Metal Hacksaw Blades (100)**  
**A9524**

High-Quality Hacksaw Blades

**Features**

- 300mm (12") x 24T x 100 Blades
- Flexible Bi-Metal High Speed Steel Blade
- Virtually Unbreakable in Normal Use
- Bi-Metal Blade Made to ISO2336

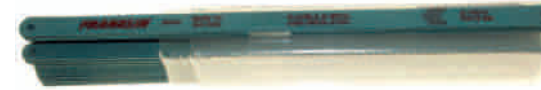

**Irwin Extra Cut Snips**  
**A04314**

Designed for numerous applications when a long cut in lightweight material is desired

**Features**

- Compound leverage design provides cuts up to 80mm
- Pro-Touch™ Grips provide superior comfort, resists twisting
- For cutting sheet metal, vinyl, plastic, rubber and many other applications
- Easy close latch



**Irwin BiMetal Hacksaw Blade (2)**  
**A04524**

High-Quality Hacksaw Blades Provide Improved Cutting Performance

**Features**

- 300mm (12") x 24T x 2 Blades
- Tooth Geometry Delivers Higher Resistance Against Tooth Strippage
- Increased Longevity and Durability
- Faster, Smoother and Less Tiring Cutting



**Franklin Hacksaw 10-12"**  
**A208**

Professional Quality Hacksaw

**Features**

- 300mm (12") x 24T Bi-Metal Blade Made to ISO2336
- Metal Tensioning Mechanism For a longer lasting tool
- Ergonomic Handle for Comfort in use



**Franklin Junior Hacksaw**

Junior Hacksaw Frame

**Features**

- Plated Steel Frame
- Rubber Finger Guard
- Supplied with Blade

Part No.	Description
R1	Junior Hacksaw Frame - Loose
R1C	Junior Hacksaw Frame - On Tag
R2	Junior Blades (Pack of 100)
R210	Junior Blades (Pack of 10)



**Irwin ProSnip Right Straight + Sharp Left**  
**A04315**

For straight or curved cuts Keeping hands safely above the work surface

**Features**

- 240mm long with a 3.02 cm length of cut
- Cut capacity of 18g/1.19mm sheet metal
- Cut capacity of 22g/0.84mm stainless steel
- Moulded ProTouch™ Grips for Added Comfort and Less Hand Fatigue





**Irwin ProSnip Left Straight + Sharp Right  
A04316**

For straight or curved cuts Keeping hands safely above the work surface

**Features**

- 240mm long with a 3.02 cm length of cut
- Cut capacity of 18g/1.19mm sheet metal
- Cut capacity of 22g/0.84mm stainless steel
- Moulded ProTouch™ Grips for Added Comfort and Less Hand Fatigue



**Wiss Easy Snip Utility Shears 200mm  
AWEZSN**

Multi Purpose Snips With Spring-Loaded Blades for Reduced Fatigue on Repeated Cuts

**Features**

- Soft-Touch Co-Molded Handles for Maximum Comfort
- 420 Stainless Blades Provide Maximum Corrosion Resistance
- Wire Cutter Notch for Easy Cutting of Light-Gauge Wire
- Safety-Latch Locks Blades Closed for Storage



**Franklin 6 pce Hand File Set 200mm / 8”  
1720**

200mm (8”) Hand Files with Soft Grip Handles

**Features**

- 8” Hand Bastard, 8” Hand Second Cut
- 8” Square Second Cut, 8” Round Second Cut
- 8” Flat Second Cut, 8” Half Round Second Cut
- Supplied in a Tool Roll



**Franklin 10 pce Assorted Needle File Set  
1685**

Pack of 10 Assorted Needle Files in a Plastic Wallet

**Features**

- 140mm Length
- Dipped Handles for Comfort in Use



**Eclipse Mechanic’s Vice 4” 100mm  
AEMV3**

High Quality Cast Iron Mechanics Vice for General Metal Working Applications

- Jaw Width - 100mm (4”)
- Throat Depth - 63mm
- Jaw Opening - 109mm
- Maximum Clamping Force - 2000Kgf

**Features**

- Body and Sliding Jaw are Manufactured from High Quality Grey Cast Iron
- Hardened Steel Replaceable Jaw Plates
- Main Screw and Tommy Bar are made from High Quality Steel
- Strong and Durable with Excellent Shock Absorbing Properties
- Tommy Bar Will Bend Before the Vice Becomes Over Stressed
- Sliding Jaw is Precision Milled to a High Tolerance for a Fast Smooth Operation
- Base has Fixing Holes for Bench Mounting



**Eclipse Mechanic’s Vice 6” 150mm  
AEMV6**

High Quality Cast Iron Mechanics Vice for General Metal Working Applications

- Jaw Width - 150mm (6”)
- Throat Depth - 86mm
- Jaw Opening - 168mm
- Maximum Clamping Force - 3000Kgf

**Features**

- Body and Sliding Jaw are Manufactured from High Quality Grey Cast Iron
- Hardened Steel Replaceable Jaw Plates
- Main Screw and Tommy Bar are made from High Quality Steel
- Strong and Durable with Excellent Shock Absorbing Properties
- Tommy Bar Will Bend Before the Vice Becomes Over Stressed
- Sliding Jaw is Precision Milled to a High Tolerance for a Fast Smooth Operation
- Base has Fixing Holes for Bench Mounting



## Franklin 39 pce Alloy Steel Tap & Die Set

### TA183

For Cleaning and Cutting Threads on Mild Steel and Aluminium

17 1" Dies and 17 Taps

- 3 x 0.50, 3 x 0.60, 4 x 0.70
- 4 x 0.75, 5 x 0.80, 5 x 0.90
- 6 x 0.75, 6 x 1.00, 7 x 0.75
- 7 x 1.00, 8 x 1.00, 8 x 1.25
- 10 x 1.25, 10 x 1.50, 12 x 1.50
- 12 x 1.75, 1/8" NPT 27

#### Features

- Metric Coarse and Fine M3-M12
- Long Handle Adjustable Tap Wrench
- 'T' Handle Tap Wrench
- Die Handle
- Screw Pitch Gauge
- Screwdriver
- Tough Impact Resistant Carry Case

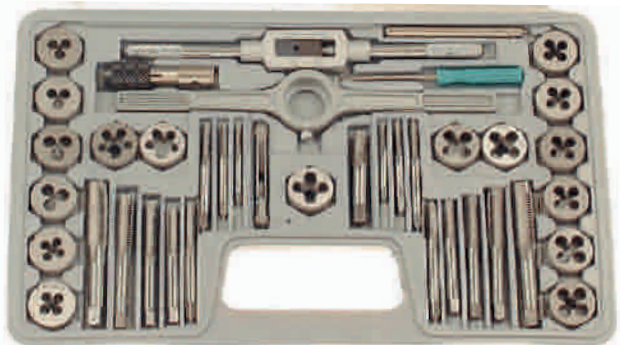

Part No.	Description
18311	Large Tap Holder
18312	Die Holder



## Franklin 45 pce Alloy Steel Tap & Die Set

### TA185

For Cleaning and Cutting Threads on Mild Steel and Aluminium

METRIC

20 1.5" and 2" O/D Dies and 20 Taps

- 6 x 1.00, 6 x 0.75, 8 x 1.25
- 8 x 1.00, 10 x 1.50, 10 x 1.25
- 12 x 1.75, 12 x 1.50, 14 x 2.00
- 14 x 1.50, 16 x 2.00, 16 x 1.50
- 18 x 2.50, 18 x 1.50, 20 x 2.50
- 20 x 1.50, 22 x 2.50, 22 x 1.50
- 24 x 3.00, 24 x 1.50

#### Features

- 2 X Tap Wrenches
- Die Stock - 2" O/D
- Die Stock Adaptor 1.5"
- Screwdriver
- Tough Impact Resistant Carry Case



Part No.	Description
18511	Large Tap Holder
18512	Die Holder





# Hand Tools - J

## Contents

<b>Pry &amp; Pick-Up Tools</b>	J2
<b>Inspection</b>	J4
<b>Parts Dishes</b>	J5
<b>Scrapers</b>	J5
<b>Extractors</b>	J6
<b>Hammers</b>	J6
<b>Trimming Knives</b>	J10
<b>Measuring</b>	J11
<b>Soldering</b>	J12
<b>Padlocks</b>	J12

**FF Franklin & Co Ltd**

Platt Street

Sheffield

S3 8BQ

England

**Telephone**

0114 272 1429

**Facsimile**

0114 272 7030

**Email**

orders@franklin-tools.co.uk

# 2020

[www.franklin-tools.co.uk](http://www.franklin-tools.co.uk)



**Franklin 24" Long Reach Pry/Screwdriver**  
**9824**

Flat ended second-class lever

**Features**

- 16 x 600mm (24")
- Full Length Square Blade
- Chrome Vanadium
- Hammer Cap
- Soft Grip Handle for Comfort in Use



**Franklin Jumbo Pry Bar 900mm**  
**9836**

First-class lever

**Features**

- 900mm (36")
- Angled Shaft
- Chrome Vanadium
- Hammer Cap
- Soft Grip Handle for Comfort in Use



**Franklin HD Extending Pry Bar 18"-30"**  
**AT9760**

Ideal for general force and alignment work

**Features**

- 24"-36"/60-90cm
- Indexable Head with push button so head can be set in the required position
- Quick release button to set the shaft to desired length



**Franklin Magnetic Pick-Up (up to 1.5 kg)**  
**TA670**

Pen style telescopic pick-up tool

**Features**

- Extends to 535mm
- Pocket Clip
- Dipped Handle for Comfort and Grip



**Franklin 4 pce Heavy Duty Pry Bar Set**  
**9840**

- 200mm (8")
- 300mm (12")
- 450mm (18")
- 600mm (24")

**Features**

- Chrome Molybdenum Steel
- Angled Shafts
- Soft Grip Handles for extra comfort in use
- Hammer Caps
- Black Finish

Part No.	Description
984200	200mm
984300	300mm
984450	450mm
984600	600mm



**Franklin Magnetic Pick-Up (up to 4.5 kg)**  
**TA669**

Pen style telescopic pick-up tool

**Features**

- Extends to 635mm
- Pocket Clip
- Dipped Handle for Comfort and Grip



**Franklin Magnetic LED Pick-Up (up to 1.5lb)**  
**TA671**

Pen style telescopic pick-up tool

**Features**

- Extends from 165mm to 660mm
- Bright LED light - inc. 3 x L736 batteries
- Pocket Clip
- Dipped Handle for Comfort and Grip





**Franklin 5 pce Mirror Pick-Up & LED Set  
TA675**

Inspection Mirror and Pick Up Set

**Features**

- Large and small inspection mirrors
- Magnetic pick up
- Combined LED torch and Telescopic magnetic pick up
- Telescopic ergonomic handle
- Supplied in a presentation case



**Franklin LED Inspection Mirror Round  
TA6770**

Allows you to make careful inspections even in the darkest of places

**Features**

- 75mm Adjustable Mirror
- Extends from 285mm to 870mm
- Ergonomic Handle for comfort in use
- 2 x Built in bright LED lights
- Supplied with 1 x CR2032 3v Lithium coin cell battery



**Franklin 6" Magnetic Parts Dish  
TA61**

For collecting parts, nuts, bolts, screws etc

**Features**

- 150mm Diameter
- Stainless
- Magnet with protective covering
- Use right way up or upside down



**Franklin Magnetic Parts Dish 305x210mm  
TA620**

For collecting smaller tools, parts, nuts, bolts, screws etc

**Features**

- 305 x 210 x 75mm
- Collapsible - Flattens for easy storage
- 2 magnets with protective covering



**Franklin 4 pce Mini Pick & Hook Set  
TA679**

Ideal For Separating Wires, Removing Small Fuses, 'O' Rings etc

**Features**

- Straight pick
- Hook pick
- 90 Degree pick
- O ring pick
- Ergonomic handles for comfort in use



**Franklin LED Inspection Mirror 50 x 75mm  
TA6771**

Allows you to make careful inspections even in the darkest of places

**Features**

- 50 x 75mm Adjustable Mirror
- Extends from 300mm to 900mm
- Ergonomic Handle for comfort in use
- 2 x Built in bright LED lights
- Supplied with 2 x CR2032 3v Lithium coin cell batteries



**Franklin Magnetic Parts Dish 300x280mm  
TA618**

For collecting smaller tools, parts, nuts, bolts, screws etc

**Features**

- 300 x 280mm
- Stainless
- 4 magnets with protective covering
- Use right way up or upside down



**BOJO® 5 pce Scraper Tool Set  
ABJ20**

For both automotive and general use

**Features**

- Angled Scraper
  - Bull Nose Scraper
  - Standard Scraper
  - Curved Edge Scraper
  - Wide Steep Angled Edge Scraper
- Features**
- Durable tools for use in sensitive scraping areas
  - Non sparking, chemical resistant, avoids deep grooving of base metal
  - A file can be used to maintain a sharp edge - when required
  - Supplied in a plastic storage case



## Franklin 5 pce Screw Extractor Set 400

- For removal of studs, broken bolts and screws etc
- 1/8" - 1/4" (M3 - M6)
  - 1/4" - 5/16" (M6 - M8)
  - 5/16" - 7/16" (M8 - M11)
  - 7/16" - 9/16" (M11 - M14)
  - 9/16" - 3/4" (M14 - M18)
- Features**
- Chrome Molybdenum Steel
  - To be used with a vari-speed drill
  - Comes with a tough plastic case



## Eclipse Automatic Centre Punch A65171

- For indenting workpiece prior to drilling - without hammering
- Features**
- 125mm long
  - Pocket clip
  - High quality carbon steel
  - Hardened and tempered point to withstand continuous use
  - Impression depth adjustment via turning knurled head
  - Punch delivered via pressure to knurled head
  - One handed operation - Hammer should NOT be used



## Hammers - Club

- A hammer for delivering short, heavy blows
- Features**
- Hardened and tempered carbon steel head
  - Non-slip, soft feel fibreglass handle
  - Resin bonded head
  - Hickory handle
  - Metal wedge
  - Polished striking faces
  - Heat treatment ensures no soft spots on striking faces
  - Head and handle assembly ensures no loose heads
  - Suitable for striking other hard implements such as cold chisels



Part No.	Description
ACH25	2.5 lb (fibre glass shaft)
ACH40	4.0 lb (fibre glass shaft)
AFH42	2.5 lb (hickory shaft)
AFH44	4.0 lb (hickory shaft)

## Franklin Dead Blow Hammer 38oz 55mm TA624

- Minimizes damage to the struck surface while reducing the amount of rebound
- Features**
- Durable urethane construction
  - Shot filled head
  - Perfect for chassis work and hubcap installation
  - Won't spark
  - Dampens rebound



## Franklin 5 pce Screw Extractor Set 450

- For removal of studs, broken bolts and screws etc
- 3/8", 5/16", 15/64", 3/16", 1/8"
- Features**
- Chrome Molybdenum Steel
  - To be used with a hammer and tap wrench
  - Comes with a tough plastic case



## Hammers - Ball Pein

- A hammer for striking metal objects more safely
- Features**
- Hardened and tempered carbon steel head
  - Hickory handle
  - Metal wedge
  - Polished and chamfered striking face to avoid chipping
  - Polished ball end for more consistent metal shaping
  - Heat treatment ensures no soft spots on striking face
  - Head and handle assembly ensures no loose heads
  - Manufactured in general accordance with British Standard BS876



Part No.	Description
ABPH16	1.0 lb
ABPH24	1.5 lb
ABPH32	2.0 lb
ABPH40	2.5 lb
ABPH48	3.0 lb



## 10 lb Sledge Hammer ASH10

- A heavy duty hammer for maximising the strength of each blow
- Features**
- Hardened and tempered carbon steel head
  - Non-slip, soft feel fibreglass handle
  - Resin bonded head
  - Polished striking faces with chamfered edges to avoid chipping
  - Longer handle for greater striking force
  - Protective collar at top of handle helps avoid potential damage due to overstriking
  - Heat treatment ensures no soft spots on striking faces
  - Manufactured in general accordance with British Standard BS876



## THOR Dead Blow Hammers

- Minimizes damage to the struck surface while reducing the amount of rebound
- Features**
- All faces are one piece moulded and are designed to wear and to be replaced by hand
  - Shot filled head
  - Used in most assembly/fitting applications including engineering
  - Won't spark
  - Dampens rebound



Part No.	Description
TH1414	2lb
TH1616	2.75lb





## THOR Copper Hide Hammers

Ideal where a heavy blow is required with a relatively small striking area that will not mark the finished work

### TH212

Face Diameter 38mm 1.1/2in  
Approximate Weight 1070g  
Approximate Length 305mm 12in

### TH214

Face Diameter 44mm 1.3/4in  
Approximate Weight 1600g  
Approximate Length 305mm 12in

### TH216

Face Diameter 50mm 2in  
Approximate Weight 2380g  
Approximate Length 355mm 14in

### Features

- Faces are designed to wear and can be replaced
- The Copper face gives a safe but high-impact blow
- The Hide face gives a firm resilient blow that will not mark the finished work
- Wooden handle

Part No.	Description
TH212	No 2 - 2.5lb
TH214	No 3 - 3.5lb
TH216	No 4 - 5.5lb



## THOR Nylon Hammers

Used, as a multi purpose striking tool in most assembly applications

### TH712

Face Diameter 38mm 1.1/2in  
Approximate Weight 650g  
Approximate Length 305mm 12in

### TH714

Face Diameter 44mm 1.3/4in  
Approximate Weight 850g  
Approximate Length 305mm 12in

### TH716

Face Diameter 50mm 2in  
Approximate Weight 1230g  
Approximate Length 305mm 12in

### Features

- Screw in white nylon faces
- Faces are designed to wear and can be replaced
- Serrations in the metal head prevent faces coming loose during use
- No metal pegs or inserts to damage the workpiece when worn
- Faces have a shoulder to prevent fracture from misdirected blows
- Plastic Handle

Part No.	Description
TH712	No 2 - 1.50lb
TH714	No 3 - 2.00lb
TH716	No 4 - 2.75lb



## THOR Copper Hammers

Ideal where a heavy blow is required with a relatively small striking area

### TH312

Face Diameter 38mm 1.1/2in  
Approximate Weight 1260g  
Approximate Length 305mm 12in

### TH314

Face Diameter 44mm 1.3/4in  
Approximate Weight 1940g  
Approximate Length 305mm 12in

### TH316

Face Diameter 50mm 2in  
Approximate Weight 2830g  
Approximate Length 355mm 14in

### Features

- Dual-Purpose soft faced hammer for the Automotive Trade
- Faces are designed to wear and can be replaced
- The Copper face gives a safe but high-impact blow
- Wooden handle

Part No.	Description
TH312	No 2 - 2.9lb
TH314	No 3 - 4.3lb
TH316	No 4 - 6.5lb



## THOR Rubber Mallets

All purpose mallet used widely for the automotive industry

### TH953

Round Head Diameter 64mm 2.1/2in  
Approximate Weight 550g  
Approximate Length 340mm 13.1/2in

### TH954

Round Head Diameter 74mm 3in  
Approximate Weight 800g  
Approximate Length 380mm 14.1/2in

### TH957

Round Head Diameter 90mm 3.1/2in  
Approximate Weight 1200g  
Approximate Length 380mm 14.1/2in

### Features

- Provides a firm blow with little rebound
- Self locking handle
- Wooden Handle

Part No.	Description
TH953	1.25lb 64mm
TH954	1.75lb 74mm
TH957	2lb 90mm



**Franklin Heavy Duty Trimming Knife Blades (10)**  
**1610HD**

60 x 18.8 x 0.63mm

**Features**

- Heavy Duty Trimming Knife Blades
- Universal Sized Blade fits most Trimming Knives
- 1 x Pack of 10 Blades



**Franklin Auto Load Utility Knife**  
**1620**

Retractable quick change utility knife

**Features**

- Quick change blade release and insertion - No screws
- Heavy duty Zinc alloy body
- Non-Slip grip
- Spare blade cassette with 5 blades



**Irwin ProTouch X Retractable Knife**  
**A08104**

The ProTouch X knife is lightweight, durable and stores 10 blades

**Features**

- Quick change blade mechanism for easy blade removal
- Trigger grip for cutting on the pull
- Hinged blade storage
- 3 step retraction for multiple cutting depths
- ProTouch for a secure grip and greater comfort



**Irwin Professional Tape Measure**

Professional Tape Measures Metric/Imperial  
3m (10ft) 5m (16ft) 8m (26ft)

**Features**

- Nylon Coated for longer life
- Fast lock for quick and easy blade control
- Double sided printing for greater visibility and convenience
- Protouch grip for comfort in use

Part No.	Description
A07793	3m (10 ft)
A07794	5m (16 ft)
A07795	8m (26 ft)



**Franklin Utility Knife - Snap off Blade**  
**1607**

Utility knife with a snap off blade

**Features**

- Sturdy plastic construction
- Easy blade replacement
- Segmented steel blade can be snapped off when cutting edge becomes dull

Part No.	Description
1610	Snap Off Blades (10)



**Irwin BiMetal Knife Blades (5)**  
**A04240**

The snub nose design helps reduce the risk of accidental puncture wounds

**Features**

- Spring steel allows the blade to bend without accidentally breaking
- High speed steel hardened cutting edge stays sharp 3X longer than traditional carbon blades
- Fits most utility knives



**Irwin FK100 Folding Knife BiMetal Blade**  
**A88437**

Folding Utility Knife

**Features**

- Keeps blade locked in place
- Safe, one-handed operation
- Comfort and control
- Wire stripper and belt clip
- Durable all metal body



**Digital Vernier Caliper 0-150mm**  
**AT842**

Enables inner / outer and depth measurements to be accurately assessed

**Features**

- Dual metric 0-150mm / imperial 0-6" scale
- Clear LCD display reading to 0.01mm / 0.0005"
- Thumb wheel adjustment
- Supplied with LR44 1.5 volt battery
- Sturdy storage case





## Franklin Tape Measure 5m / 16ft TA855

5 Metres / 16 Feet - Retractable Measuring Tape

### Features

- Dual Marked 25mm Wide
- Professional quality measuring tape
- Power return - Positive lock
- Plated belt clip
- Wrist strap
- Non slip ergonomic grip



**FRANKLIN**  
Professional Quality Tools

## Franklin Iron Padlocks

High Quality Iron Padlock

### Features

- Hardened steel shackle
- Body Material: Iron
- Surface Treatment: Black Coated
- Cylinder: Brass
- Spare keys provided

Part No.	Description
363	32mm
364	38mm
365	50mm
366	63mm



**FRANKLIN**  
Professional Quality Tools

## Power Probe Micro Torch APPMT

Butane powered tool useful for soldering, brazing, loosening fasteners etc

### Features

- Sturdy construction
- Electronic ignition
- Flame adjustment
- Butane refillable
- Lasts up to 2 hours between refills



**POWER PROBE**

## Power Probe Soldering Kit APPSK

Butane powered pen style soldering tool

### Features

- Electronic ignition
- Electronic flame adjustment
- Accessories Tips and Attachments Included
- Butane refillable
- Sturdy organized case



**POWER PROBE**

# Lights - K

## Contents

Inspection Lights	K2
Head Torches	K7
Hand Torches	K10
Work Lights	K13
Miscellaneous	K15

**FF Franklin & Co Ltd**

Platt Street

Sheffield

S3 8BQ

England

**Telephone**

0114 272 1429

**Facsimile**

0114 272 7030

**Email**

[orders@franklin-tools.co.uk](mailto:orders@franklin-tools.co.uk)

# 2020

[www.franklin-tools.co.uk](http://www.franklin-tools.co.uk)





**Led Lenser 150 Lumen Rechargeable Inspection Lamp**  
**BIW4R**

Pen-sized rechargeable pocket work light - 150 Lumen

**Features**

- Compact pocket size (27 x 20 x 156mm)
- Three light options including focused spotlight with reflector lens in the lamp head
- Battery indicator
- Built-in magnet to easily attach to metal surfaces (e.g. steel beams or motors)
- Tilt mechanism for flexible orientation for optimal illumination of the workspace
- IP Rate - IPX54
- USB cable included
- 7-Year with registration warranty



**Led Lenser 300 Lumen Rechargeable Inspection Lamp**  
**BIW5R**

Rechargeable pocket-sized work light - 300 Lumen

**Features**

- Size (39 x 35 x 159mm)
- Durable metal-coated plastic housing
- Chip-on-Board technology for even light distribution
- Rechargeable via USB connector in only 3.5 hours
- Battery indicator
- Aluminium housing
- USB cable included
- Flexible attachment hook with magnet
- Tilt mechanism for optimally illuminated construction site
- 7-Year with registration warranty



**Led Lenser 2500 Lumen Rechargeable Floodlight**  
**BIF4R**

Rechargeable compact floodlight - 2500 Lumen

**Features**

- Super compact (235 x 44 x 111mm)
- Built-in magnet to easily attach to metal surfaces (e.g. steel beams)
- Five brightnesses with a luminous flux of up to 2,500 lumen
- Built-in power bank supplies power for cellphones and other devices
- Efficient cooling element for a long life and optimum performance
- IP Rate - IPX54
- Battery indicator
- Flexible case and carrying handle
- 7-Year with registration warranty



**Led Lenser 600 Lumen Rechargeable Flexi Inspection Lamp**  
**BIW5RF**

Rechargeable flexi mini work light - 600 Lumen

**Features**

- Size (40 x 32 x 151mm)
- Folding, slim lamp head for inaccessible spaces
- Chip-on-Board technology for even light distribution
- Light options: focused spot light and broad work light
- USB charging (cable included)
- Two brightnesses with a luminous flux of up to 600 lumen
- Battery indicator
- Magnetic holder and hook
- 7-Year with registration warranty



**Led Lenser 600 Lumen Rechargeable Inspection Lamp**  
**BIW7R**

Rechargeable compact work light - 600 Lumen

**Features**

- Size (46 x 40 x 202mm)
- Durable Aluminium housing
- Three light options including focused spotlight with reflector lens in the lamp head
- Luminous flux of up to 600 lumen
- Charges in the charging station
- USB cable included
- Battery indicator
- Flexible hook and magnet
- 7-Year with registration warranty



**Led Lenser 4500 Lumen Rechargeable Floodlight**  
**BIF8R**

Rechargeable compact floodlight - 4500 Lumen

**Features**

- Size (307 x 44 x 142mm)
- Built-in magnet to easily attach to metal surfaces (e.g. steel beams)
- Remote control option via Bluetooth® app
- Five brightnesses with a light output of up to 4,500 lumen
- Up to 12 hours battery life
- Battery indicator
- Flexible base/handle with magnet
- IP Rate - IPX54
- Large, tough handle for easy transport
- Built-in power bank supplies power for cellphones and other devices
- 7-Year with registration warranty



**Franklin 280 Lumen Flexi-Blade Light  
BFC280**

Re-chargable COB worklamp with hook and magnetic base

**Functions**

- First click - High beam
- Second Click - Low beam
- Third Click - LED Torch
- Hold button for Red + Red Flashing function

**Features**

- COB Strip for main illumination
- Secondary LED Torch for more focused illumination
- 270 Degree Rotation
- 280 Lumen
- USB cable charging
- Recharge time: 4 hours
- Discharge Time: 2.5 hours
- Battery: 1 X 18650 rechargeable li-ion battery (Built in)
- IP Rate: IP44
- Size: 150 X 50MM (after folding)
- Weight: 145g



**Gerlux COB LED Flexi Strip Worklamp  
BLEDF3**

Re-chargable COB LED Flexi Blade worklamp with magnetic base for hands free use.

**Functions**

- First Press - Illuminates COB Strip Blade
- Second Press - Illuminates End Torch
- Third Press - Switches Off

**Features**

- 3 Watt COB LED Strip
- 1 Watt SMD LED
- Up to 350 Lumens on COB LED Strip
- 60 Lumens on SMD LED
- 90 Degree Flexible Blade for pinpoint illumination
- Virtually Unbreakable Lens
- Rubber coated handle for Good Grip
- Magnetic Base
- Up to 3 hours runtime on COB LED and 10 hours on High Powered LED
- Built in Li-Ion Battery



**Powerhand Rechargeable 500 Im Flexi Lights**

Rechargeable 500 Lumen Flexi Light

**Features**

- Ultra low profile head
- Reinforced flexible neck - Can be positioned exactly as required
- Adjustable dimmer switch - 50 - 500 lumen
- 120 lumen spot light
- Magnetic base with hanging hook
- Robust, shock resistant housing
- USB charge socket
- Battery charge monitor

Part No.	Description
AP37BL	Blue
AP37G	Green
AP37R	Red
AP37O	Orange
AP37Y	Yellow



**Powerhand Extreme 7+1 SMD Flexi Lamps 330Im**

Multi-function SMD inspection lamp with a 180° flex design. This lamp can be positioned almost anywhere for excellent working conditions

**Features**

- 330 Lumens
- 7 SMD main light and 1 HPL torch light
- Lithium-Ion Battery 3,7V 2.2Ah
- Charge Time 5 hours
- Can Be Charged Via USB
- Running Time Up to 7 Hours
- 180° Flex Design
- Three Strong Integrated Magnets
- Two Hanging Hooks

Part No.	Description
AP10Y	Yellow
AP10O	Orange

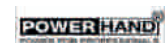



**Nightsearcher Star Blade - Ultra Slimline Rechargeable LED Inspection Light 300 Im**  
**BNSBLD**

Ultra slim inspection light and the perfect tool for illuminating hard to reach areas

**Features**

- Powerful 300 lumens
- Runtime - 3 hours
- Charging time - 4 hours
- Slim design
- Exceptional light output new technology 3W COB LED
- Produces clear white light
- Rechargeable 3.7V 2200mAh Li-ion battery
- Magnetic base for hands free use
- Integrated hanging hook
- Supplied with: AC mains, DC vehicle charger, Micro USB cable



**Nightsearcher Tri-Spector 3 in 1 Inspection Light 600Im**  
**BNTRIS**

3 in 1 Inspection light kit

**Features**

- Kit includes:
  - 1 x Flexible light, 1 x Folding slimline light + torch
  - 1 x Zoom focus flashlight Narrow to Wide
- Quick release function
- 360° Rotating light head
- Powerful magnetic base and Hanging hook
- 4 hour charging time
- Rechargeable Lithium battery (3.7V 2600mAh)
- Battery status indicator
- Resistant to chemicals and workshop solvents
- Supplied with AC adaptor + charging cable
- Sturdy storage case



**Nightsearcher i-Spector 700 - Rechargeable LED Inspection Light 700 Im**  
**BNI700**

The perfect companion for mechanics, workshops, bodysshops and other inspection work

**Features**

- Powerful 700/300/150 lumens
- 4 Light Modes: High, medium, low, torch
- Runtime - High: 2 | Medium: 4 | Low: 8 | Torch light: 8 hours
- Charging time - 4 hours
- Rechargeable Li-ion inspection light
- Toughened optical lens
- Battery charging indicator
- 360° rotate and swivel hanging hook
- Robust housing - Resistant to chemicals and workshop solvents
- IP Rate - IPX54
- Anti slip grip
- Strong magnetic base
- Supplied with: AC charger



**Nightsearcher Micro 1000 LED Work Light**  
**BNM100**

Compact rechargeable LED worklight

**Features**

- 1000 lumen light output
- Runtime of up to 2.5 hours
- Rechargeable lithium-ion battery (3.7V 2600mAh)
- 360° multi-directional light
- 90° glass lens for wider light beam
- Hanging hook
- Magnetic base
- Battery status and charging indicator
- Supplied with USB charging cable



**Powerhand Cordless SMD Palm Lamp**

Multi-function SMD inspection palm lamp with a 180° flex design

**Features**

- 5SMD for main illumination
- 300 Lumen
- Strong Magnetic Base
- 180 Degree Flex Positioning
- USB cable charging
- Pocket Clip with Integrated Swivel Hook
- Durable Shock Resistant Casing
- Recharge time: 6 hours
- Battery: 1 X 3.7v rechargeable li-ion battery
- IP Rate: IP54
- Weight: 170g



Part No.	Description
AP25R	Red

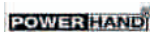

**Nightsearcher Light Wave - Rechargeable Wide Beam Head Torch 150 Im**  
**BNLW**

Rechargeable wide beam head torch with intelligent motion sensor for touchless light wave control

**Features**

- Powerful 150/75 lumens • 20 metre wide beam
- 4 Light Modes: High, SOS, Half, Sensor • Wide beam area coverage
- Rechargeable Li-ion 3.7V 2200mAh battery
- Runtime - High: 4 hours | Low: 8 hours
- Charging time - 2 hours
- Battery charging Indicator
- IP Rate - IPX44
- Adjustable 180° housing
- Smart sensor indicator
- Motion sensor activated
- Adjustable head strap
- Supplied with: USB Charging cable

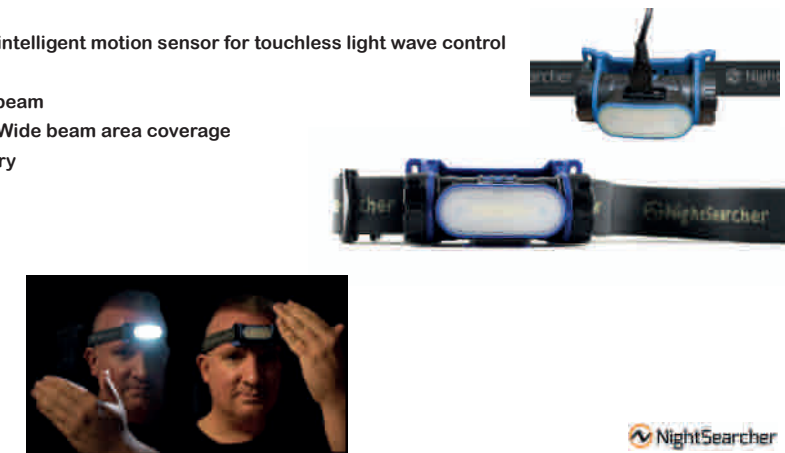

**LED Lenser H7R.2 Rechargeable 300 lm  
B7298**

Powerful 300 Lumen Head Torch

**Features**

- Luminosity - MAX 300 lm - MIN 20 lm
- Lighting Range - MAX 160 m - MIN 50 m
- Battery Duration - MAX 30 h - MIN 4 h
- Advanced Focus System
- Long Range Beam or Wide Spread Flood Light
- Five light options - High Power, Low Power, Boost, Dim, Signal
- Rear Red light with 2 modes (Static/Flash)
- Low Battery' warning light
- Recharged via the supplied Mains/USB charging options
- Will also operate off standard AAA batteries



**LED Lenser Rechargeable 180 lm iSEO5R  
B5605R**

Rechargeable yet lightweight head torch with a front battery pack

**Features**

- Luminosity - MAX 180 lm - MIN 20 lm
- Lighting Range - MAX 120 m - MIN 40 m
- Battery Duration - MAX 20 h - MIN 5 h
- IP Rate - IPX6
- Three different light modes - High, Low power and Blink mode
- USB charging
- Water resistant



**LED Lenser H14R.2 1000 lm Rechargeable  
B7299R**

Professional rechargeable head torch with sensational performance

**Features**

- Luminosity - MAX 1000 lm - MIN 60 lm
- Lighting Range - MAX 300 m - MIN 70 m
- Battery Duration - MAX 35 h - MIN 6 h
- Intense spot (distance) or flawless flood (near) illumination
- Multi-function Dynamic 'wheel' switch
- Rear safety light with red or blinking light options
- Battery Life Indicator
- Charging by supplied mains or USB charging connectors
- 7 Year Warranty - With Registration



**LED Lenser H6R 200 lm Rechargeable  
B7396R**

Rechargeable premium LED compact head torch

**Features**

- Luminosity - MAX 200 lm - MIN 5 lm
- Lighting Range - MAX 120 m - MIN 20 m
- Battery Duration - MAX 40 h - MIN 2 h
- Advanced Focusing for flood (near) and spot (distance)
- Detachable overhead band
- IP Rate - IPX4
- Supplied with 3 x AAA NiMH rechargeable batteries, USB charging cable, overhead band, pouch
- Also works with 3 x AAA standard alkaline batteries (not supplied)
- 5 Year warranty with registration



**LED Lenser H-SERIES H8R 600 lm Rechargeable Head Lamp  
B00852**

Powerful 600 lumen professional head torch

**Features**

- Luminosity - MAX 600 lm - MIN 10 lm
- Lighting Range - MAX 150 m - MIN 20 m
- Battery Duration - MAX 120 h - MIN 10 h
- Advanced Focus System
- Adjusts perfectly to your head and is comfortable to wear
- USB rechargeable
- Battery life: 15 h - 120 h (boost mode): 10 h
- Battery recharge time: 6 h
- USB charger included
- Waterproof



**Nightsearcher Zoom 580R Rechargeable Head Torch  
BN580R**

An advanced spot-to-flood head torch using a Zoom Focus advanced optical focus system

**Features**

- 580 lumen/150 metre beam
- Runtime of up to 18 hours
- Rotate bezel for spot-to-flood beam
- Cool white spot beam/Warm white diffused beam
- 90° beam angle adjustment - just tilt the torch head
- Adjustable three-point head band
- Helmet-mountable with optional clips
- Rechargeable 3.7V 800mAh lithium-ion battery
- Can also be used with 3 x AAA Alkaline batteries (not supplied)
- Supplied with battery pack and USB charging cable





## Nightsearcher RiteStar Pen Light 50 Im BNRSP

Compact inspection penlight perfect for closeup work

### Features

- Natural daylight colour - 95 CRI
- 50 lumen light output
- Runtime - 1.5 hours
- Perfect colour matching rechargeable pen light
- Adjustable slide focus: Spot - Flood beam
- 2 x AA batteries included



## Franklin 12" Flexible Magnetic LED Light FL5

Flexible Magnetic LED Light

### Features

- Intense white LED light
- 250mm flexible arm
- Up to 100,000 hours bulb life
- Magnetic foot
- 3 x LR44 batteries (supplied)



## LED Lenser I-SERIES i2 B5602

One of the lightest in the Ledlenser i-range

### Features

- Luminosity - MAX 105 lm - MIN 105 lm
- Lighting Range - MAX 170 m - MIN 170 m
- Battery Duration - MAX 6.5 h - MIN 6.5 h
- On/Off switch on the end of the barrel
- Speed focus beam adjustment
- Uses three AAA alkaline batteries (included)
- Battery Duration - 6.5h
- Rechargeable NiMH battery packs may also be used
- IP Rate - IPX4

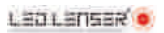

## LED Lenser I-SERIES i6R Rechargeable - 120 Lumen B5606R

High Performance pen-light torch

- Luminosity - MAX 120 lm - MIN 10 lm
- Lighting Range - MAX 100 m - MIN 30 m
- Battery Duration - MAX 25 h - MIN 4 h

### Features

- Advanced focus system
- Flood or spot beam
- Easy-grip metal body
- Single hand speed focus
- Rechargeable through the supplied docking station
- Dynamic Switch
- USB connection
- IP Rate - IPX4
- Supplied with USB Cable and pouch



## LED Lenser P4 18 Im B8404

Ballpoint pen sized LED pocket torch

### Features

- Luminosity - MAX 18 lm - MIN 18 lm
- Lighting Range - MAX 25 m - MIN 25 m
- Battery Duration - MAX 8.5 h - MIN 8.5 h
- Pocket clip
- Jet aircraft grade aluminum
- Rear end cap switch
- IP Rate - IPX4
- 2 x AAA Alkaline batteries (included)
- 5 Year warranty with registration

LED LENSER P4 18 Im



## LED Lenser P7 Torch 450lm B00900

A hard wearing easy to carry torch with the latest in LED technology

### Features

- Lumens: Power: 450, Mid Power: 250, Low Power: 40
- Beam Distance: Boost: 300m, Power: 220m, Low: 100m
- Burn Time: Boost: 1h, Power: 2h, Low: 25h
- IPX Rating: 4 - protection against water splashing from any direction
- Focus System: Advanced Focus System with speed focus (spot/flood)
- Battery: 4 x AAA batteries
- Weight: 175g including batteries
- Nylon pouch



## Led Lenser P7R Rechargeable Torch 1000lm B9608R

Popular flashlight with a smooth design that fits comfortably in your hand

### Features

- Lumens: High: 1000, Standard: 250, Low: 20
- Beam Distance: High: 210m, Standard: 150m, Low: 40m
- Burn Time: High: 2h, Standard: 5h, Low: 40h
- IPX Rating: 4 - protection against water splashing from any direction
- Focus System: Advanced Focus System with Focus Lock
- Battery: 1 x rechargeable ICR18650 Lithium Ion
- Charge Time: Up to 5 hours
- Weight: 210g



## Nightsearcher Galaxy-1200 LED Work Light 1200lm BNGM12

A compact rechargeable LED work light, with a powerful 1200 lumen light output

### Features

- 1,200 Lumens - 50 metre beam
- Running time 7 hours
- Rechargeable lithium battery - 3.7V 4400mAh
- 180° Rotating Swivel Stand
- USB rechargeable
- Ultra powerful magnetic handle
- Battery charging + status indicator
- USB Power bank facility to charge your phone/tablet
- Supplied with: USB charging cable



## Nightsearcher Explorer-1000 - Rechargeable LED Tactical Flashlight 1000 Im BNE100

Professional rechargeable, LED tactical flashlight

### Features

- Powerful 1000 lumens
- 600 metre spot beam
- Runtime 50 hours
- Charging time 6 hours
- 6 light modes: 100%/60%/30%/5%/Strobe/SOS
- 2 switches - Tail cap tactical and body
- Through switch battery status indicator
- Bright CREE XLAMP XML U2 LED lights
- IP-rating - IPX7 (immersion up to 1 metre of water)
- 3.7V, 2600mAh Li-ion battery
- Supplied with: USB Charging cable



## Nightsearcher Galaxy Star Heavy Duty Work Light 2800lm BNGSTR

A robust, portable, rechargeable work light with a powerful 2800 lumen output

### Features

- 2,800 Lumens - 90 metre beam
- Running time 11 hours
- Rechargeable lithium battery - 7.4V 2200mAh
- 180° Rotating Swivel Stand
- Battery charging + status indicator
- USB Power bank facility to charge your phone/tablet
- Supplied with AC charger

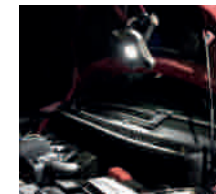

## Nightsearcher Galaxy Hazard LED Work and Hazard Light 1200lm BNGHAZ

A powerful yet compact rechargeable LED Hazard/ Work Light, Ideal For Use In Vehicles

### Features

- 1,200 Lumens - 50 metre beam
- Runs up to 9 hours
- Two Light Modes: Central white flood light, Red flashing triangle hazard light
- Rechargeable lithium battery - 2 x 3.7V 2200mAh
- USB rechargeable
- USB Power bank facility to charge your phone/tablet
- 180° Degree foldable bracket/handle and Fold flat design for compact storage
- Magnetic carry handle
- Battery charging + status indicator
- Supplied with: USB Charging cable



## Nightsearcher 700 Im RiteStar 700 BNRS70

Identifies any blemishes, scratches or imperfections in any paint finish, so ideal for Bodyshop, Spray Booth, Polishing and automotive industry

### Features

- Natural daylight colour - 95 CRI
- 2 Light modes: High 700lm, Half 300lm
- Runtime - 4 hours • Charge time - 4 hours
- IP Rate - IPX65
- Battery status and charging indicator
- 360 degree rotate and swivel hanging hook
- Resistant to chemicals and workshop solvents
- Carry handle • Adjustable stand
- Optional tripod mount • Charging station
- Strong magnetic base • IK07 impact resistant
- 3.7V, 2200mAh Li-ion battery
- Supplied with: AC charger + USB cable and charging base



Part No.	Description
BNRS7B	Under Bonnet Bracket



**Nightsearcher Key-Star - Searchlight Performance on a Keychain 300 Im**  
**BNKSTR**

The perfect carry-around this tiny rechargeable keychain has an impressive searchlight-worthy performance

**Features**

- Powerful 300 lumens
- 110 metre beam
- Battery charging and status indicator
- Runtime - 17 hours
- Charging time - 4 hours
- USB charging cable included
- 2 Light modes - High, Dimmable
- Lock mode (on/off switch)
- IP Rate - IPX4
- USB charging port



**Nightsearcher Beanie-X Beanie Head Torch 200Im**  
**BNBNX**

Knitted hat with an integrated removable and USB-rechargeable LED light pod  
Upgraded version now with 3 light modes

**Features**

- 200 lumens with 25 metre beam
- Runtime 4-10 hours
- Three light modes: Spot, Flood and Red
- Rechargeable Lithium battery
- One size fits all, unisex model
- Ultra bright LEDs
- Recharges from any USB socket
- Battery charging indicator



**Nightsearcher StarBuddy - Multi-functional LED worklight 180 Im**  
**BNBUDY**

Multifunctional LED COB worklight with 4 light modes, suited for automobile workshops and emergency applications

**Features**

- Powerful 180 lumens
- 80 lumens inspection torch
- 5 metre beam
- Runtime - Flood: 3hrs | Red Flashing lights: 6hrs | Torch: 3.5hrs
- 4 light modes - HIGH • LOW • TORCH • FLASHING
- Red flashing emergency light + white light
- Led floodlight COB 1.5W LED Strip
- Adjustable stand
- Hanger
- Magnetic base
- 3 x AAA batteries included



**Nightsearcher Beanie-B Beanie Head Torch 150Im**

Knitted hat with an integrated removable and USB-rechargeable LED light pod

**Features**

- 150 lumen with 14 metre beam
- Runtime of 2-4 hours
- Removable, rechargeable LED light pod
- High quality knitted hat
- One size fits all, unisex model
- 4 x ultra bright LEDs
- Light pod recharges from any USB socket
- Battery charging indicator



Part No.	Description
BNBNB	Black
BNBNY	Yellow
BNBNR	Red



**Nightsearcher LifeGuard - Multi-functional LED Work Light 200 Im**  
**BNLGRD**

Powerful multifunctional floodlight and torch that is a car emergency kit all in one

**Features**

- 200 lumens LED floodlight (includes Flashing mode)
- 2W COB LED inspection lamp/torch 70 lumens
- Runtimes: Floodlight 2.5 hours | light/torch 3 hours | Flashing mode 5 hours
- 5 metre beam
- Red flashing emergency warning lights
- Strong magnetic side for attaching
- Belt Cutter
- On/off switch between light modes
- Magnet
- Window Breaker



**Nightsearcher Solar Sentry 1100RC - Remote Controlled Solar Wall Light 1100 Im**  
**BNSS11**

Motion sensor security light providing extra lighting to yards, driveways, and gardens for added security

**Features**

- Powerful 1100 lumens
- Runtime - 8 hours
- Charging time - 6-8 hours
- Remote control
- Indicator Lights for the 5 night modes
- Easy installation - No wires
- Day and night auto sensors
- Efficient solar panel - Fully recharges in 6-8 hours
- 8 Metre sensor detection - Lights up for 30 seconds when activated
- Battery charging indicator
- Light output (lm) 1100 lumens
- IP65 Waterproof rating



## Nightsearcher Solar Sentry 400 Lumen BNSS40

Motion sensor solar Powered Eco-Friendly Wall Security Light

### Features

- Powerful 400 lumens
- Easy installation - No wires
- Day and night auto sensors
- Three night light modes
- Fully Recharges in 6-8 hours
- 8 Metre sensor detection
- Lights up for 30 seconds when activated
- IP65 Waterproof rating

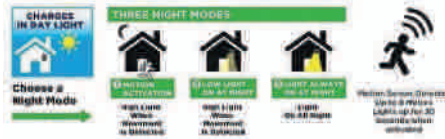
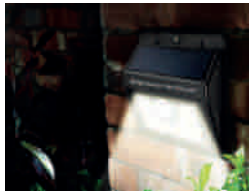

NightSearcher

## Nightsearcher Work Star Connect Work Light 2500lm BNWSTR

A compact rechargeable LED work light with a powerful 2500 Lumen output and 4 power tool adapters

### Features

- 3 light modes – High, Medium, Low
- Beam Distance up to 25m
- Run Time - Up To 16 Hours
- Powerful 2,500 Lumens
- Tripod mountable
- Toughened glass lens
- IP54 Rating
- 4 X Powerful Magnetic Feet
- Adjustable stand with hanging hook
- 4 power tool adapters which accepts these battery brands:  
Black andamp; Decker, Bosch, Makita, Stanley  
Dewalt, Porter and Milwaukee 14-21V



NightSearcher



# Air Tools - L

## Contents

PCL Airtech	L2
Ingersoll Rand	L3
Blow Guns	L5
Air Gun Accessories	L6
Hoses	L6
Coupling & Adaptors	L10

**FF Franklin & Co Ltd**

Platt Street

Sheffield

S3 8BQ

England

**Telephone**

0114 272 1429

**Facsimile**

0114 272 7030

**Email**

[orders@franklin-tools.co.uk](mailto:orders@franklin-tools.co.uk)

# 2020

[www.franklin-tools.co.uk](http://www.franklin-tools.co.uk)





**For the full range of Air Tools please visit:**  
[www.franklin-tools.co.uk](http://www.franklin-tools.co.uk)

**PCL Prestige Air Ratchet 1/2" dr 1058 Nm**  
**APP203**

This lightweight composite body 1/2" Impact Wrench offers the latest low noise and low vibration tool technology. Maintaining a very powerful level of torque and low average air consumption, this is a tool for the serious professional.

**Features**

- Ergonomic design for comfort
- Lightweight
- Reduced vibration
- Twin hammer impact mechanism
- Maximum Torque: 1,058 Nm
- Free Speed: 7,700 rpm
- Weight: 1.94 kg



1/2"

**PCL Die Grinder - 6mm Collet**  
**APT702**

This Die Grinder has high velocity and low vibration

**Features**

- Medium motor size
- Safety throttle lever
- Rear exhaust through handle
- High velocity, low vibration
- Collet Size: 6 mm
- Free Speed: 22,000 rpm
- Weight: 0.55 kg



**PCL Stubby Impact Wrench 1/2" dr 678 Nm**  
**APP200**

Combines the same high power of a standard size impact wrench in a small, lightweight and compact housing

**Features**

- Smallest and Most powerful 1/2" dr 'Stubby' impact wrench on the market
- Ideal for small engine repair, transmission work and overall automotive service work
- Length - 108.5 mm long
- Ergonomic housing design for comfort
- Handle exhaust directs air away from workspace and operator
- Maximum Torque: 678 Nm
- Free Speed: 10,000 rpm
- Weight: 1.3 kg

1/2"



**PCL Mini Cut Off Tool 75mm dia**  
**APT719**

This Cut Off Tool works with cutting disks of 3"/75mm dia giving it the ability to work efficiently in small confined spaces

**Features**

- For light cutting tasks
- Rear exhaust through handle
- Positive throttle action with safety feature
- Metal safety guard
- Disc Size: 3" / 75 mm
- Free Speed: 20,000 rpm
- Weight: 1 kg



**IR 15QMAX Quiet Ultra-Compact Impactool 3/8" dr 6**  
**J15QM**

This stubby impact wrench with a One-handed forward/reverse push button and 3-mode power regulator for maximum control

**Features**

- Nut Busting Torque - 475ft/lb (650Nm)
- Forward Torque - 310ft/lb (420Nm)
- Max Reverse Torque - 380ft/lb (520Nm)
- Weight - 1.10kg
- Length - 117mm
- Min Hose Size - 3/8" (10mm)
- PSI - 90 / BAR - 6.2
- 2-year warranty

3/8"





## IR 2235QtiMAX Wrench 1/2" dr 1220 Nm J2235Q

With a high torque output and durability make this a go to tool for even the harshest of work environments

### Features

- Nut Busting Torque - 1300ft/lb (1760Nm)
- Max Reverse Torque - 900ft/lb (1220Nm)
- Weight - 2.10kg
- Length - 193mm
- Min Hose Size - 3/8" (10mm)
- More torque, durability, and efficiency
- Lightweight and balanced
- Optimized for the vehicle repair industry etc
- 2-year warranty

1/2"



## IR 285B-6 Impact Wrench 1" dr 2400 Nm J285B6

Great for any garage, changing tyres and deeper fastening will be a breeze

### Features

- Forward Torque - 1475ft/lb (2000Nm)
- Max Reverse Torque - 1475ft/lb (2000Nm)
- Weight - 12.61kg
- Length - 519mm
- Min Hose Size - 3/4" (19mm)
- PSI - 90 / BAR - 6.2
- Feather-touch trigger enables control of the air impact wrench
- For the vehicle repair industry etc
- 1-year warranty

1"



## IR 35MAX Quiet Ultra-Compact Impact Wrench 1/2"dr 610Nm J35MAX

No other compact impact wrench on the market can match the combined power and light weight of the 35MAX

The compact design helps you access areas which are hard to reach

### Features

- Forward Torque - 360ft/lb (490Nm)
- Max Reverse Torque - 450ft/lb (610Nm)
- 8000 rpm free speed
- Weight - 1.10kg / Length - 117mm
- Min Hose Size - 3/8" (10mm) - PSI - 90 / BAR - 6.2
- One-handed forward/reverse push button
- Easy to operate 3-mode power regulator dial
- 2-year warranty

1/2"



## IR LA437-EU Pop Riveter 3/16" JLA437

This riveter will make light work of all riveting operations  
Supplied with nipples for various shank sizes

### Features

- Rivet Capacity 2.4 to 4.8mm
- Stroke Length 16mm
- Net Weight 2.8 Kg
- Overall Length 165mm
- Overall Height 260mm
- Air Inlet - 1/4"
- Air Hose - 10mm
- Air inlet with swivel jaw
- Rivet bushes container



## PCL 9" Plastic Blow Gun BG5007

Suitable for use with both air and water

### Features

- Ergonomically designed handle, for comfort in use
- Valve allows trigger-adjustable airflow
- Maximum Supply Pressure - 10 bar / 140 psi
- Connection - 1/4 Female
- Air Flow - 270 l/min / 9.3 cfm
- Outlet pressure on blowguns should not exceed 2 bar / 28 lbf/in<sup>2</sup>
- It is therefore recommended that an in-line regulator is fitted to your air supply to ensure this



## PCL 2 Bar Safety Blow Gun BG5009

2 bar automatic pressure reduction Auto Safety Blowgun

### Features

- Ergonomically designed handle, for comfort in use
- Innovative nozzle design ensures that the airflow cannot be blocked
- Valve allows trigger-adjustable airflow
- Maximum Supply Pressure - 16 bar / 232 psi
- Air Inlet - Rp 1/4
- Air Flow - 140 l/min / 4.9 cfm (at 8 bar supply)
- Complies to OSHA noise level spec 1910.95
- Conforms to HSE requirements



## Franklin Air Blow Gun TA328

Sturdy plastic air blow gun

### Features

- 1/4" BSP inlet
- Working pressure 75-120 PSI
- Ergonomic Handle for comfort in use
- Supplied with quick release coupling



## PCL 5 pce Air Chisel Set APT20

5 Piece Chisel Set suitable for Air Hammers

### Features

- Supplied in a tool roll
- Chisel shank size .401" Parker Taper
- Chrome moly forged for longer life 10mm diameter 175mm length



## PCL Mini Speed Regulator APA91

The Mini Speed Regulator is designed to enable the user to turn a powerful sander into a precision buffing tool

### Features

- Standard 1/4" male threaded end
- Heavy duty all steel design
- Speed wheel allows simple increase or decrease of free speed



## JAMEC Pro Series 20m Air Hose Reel A20AIR

Developed for today's demanding conditions, stays flexible in the cold and doesn't kink in the heat, allowing full flow in all-weather conditions

### Features

- Auto lock / auto rewind
- Hose layering system
- Solid brass internal spindle
- Hose material Extreme Ultraflex Reinforced Hose
- Reel case/type Retractable/Polypropylene
- Max. working pressure 300 psi
- 180° swivel wall mount bracket
- Leader hose 2 m with brass fittings
- Adjustable hose stop



## PCL Hose Hi Visibility - 3/8" 10mm

Reinforced air hose manufactured in high visibility yellow material for extra safety

### Features

- Excellent abrasion resistance
- Good flexibility and kink resistant
- Resistance to oil and fuels
- Silicone free
- Working Pressure - 290 psi / 20 bar
- Burst Pressure - 60 bar (3:1 safety factor)
- Hose Inside Diameter - 10 mm / 3/8 in

Part No.	Description
AH2044	10 metre
AH2022	15 metre



## PCL Rubber Hose Vertex / PCL fitting

Rubber PVC Alloy (PTE) compound air hose that doesn't have the downsides associated with rubber  
With Vertex Coupling and Standard Adaptor ends

### Features

- Excellent abrasion resistance
- Good flexibility and kink resistant
- Resistance to oil and fuels
- Silicone free
- Working Pressure - 300 psi / 21 bar
- Burst Pressure - 63 bar (3:1 safety factor)

Part No.	Description
AH2134	10m x 10mm
AH2139	15m x 10mm



## PCL Whip Hose

Air Tool Whip Hoses which distances an air tool from its air supply to prevent vibration is highly recommended by Health and Safety

### Features

- Helps to prolong the life of couplings and adaptors
- Increases comfort of use
- Enables you to use the tools safely.
- Simply Plug-in and go
- Working Pressure - (1)300 psi / 21 bar
- Burst Pressure 63 bar / 3:1 Safety Factor

Part No.	Description
AH2108	7mm x 1/4" BSTP
AH2109	10mm Hose x 3/8" BSTP
AH2116	13mm x 1/2" BSTP
AH2149	10mm Hose x 1/4" BSTP



## PCL 10mm Hose + XF Fittings

Rubber PVC Alloy (PTE) compound air hose that doesn't have the downsides associated with rubber with XF Coupling and Adaptor ends.

### Features

- Excellent abrasion resistance
- Good flexibility and kink resistant
- Resistance to oil and fuels
- Silicone free
- Working Pressure - 300 psi / 21 bar
- Burst Pressure - 63 bar (3:1 safety factor)

Part No.	Description
AH2141	10 metre
AH2142	15 metre





## PCL 15m 13mm Rubber Hose with series 100 fittings AH2150

Rubber PVC Alloy (PTE) compound air hose that doesn't have the downsides associated with rubber  
With 100 Series Coupling and Adaptor ends

### Features

- Excellent abrasion resistance
- Good flexibility and kink resistant
- Resistance to oil and fuels
- Silicone free
- Working Pressure - 300 psi / 21 bar
- Burst Pressure - 63 bar (3:1 safety factor)



## PCL Air Hose Reel - 15m AHB103

Ideal for use with a multitude of applications where a wall or post mounted reel is needed

### Features

- Quality PVC hose
- Adjustable hose stopper - Hose can extend and stop at any length
- Auto layering mechanism - helps eliminate hose kinks and jams
- Easy user manoeuvrability - mounting bracket pivots 180 degrees
- Solid brass inlet
- Maximum Working Pressure - 200 psi / 13.8 bar
- Hose Length - 15 m
- Hose Inside Diameter - 3/8 in / 10 mm
- Inlet Thread - Rp 1/4 - Outlet Thread - R 1/4



## PCL Coiled PU Hose

Polyurethane PU Coiled Air Hoses help keep the work area clear of entanglements and trip hazards

### Features

- Polyurethane (PU) material
- Nickel plated 360° swivel fittings
- 200 m straight ends with spring guard
- Hose recoils to a fraction of it's working length
- Maximum Working Pressure - 200 psi / 14 bar (AH5213)
- Maximum Working Pressure - 150 psi / 10 bar (AH5220)

Part No.	Description
AH5213	7.5m x 1/4" BSP
AH5220	10m x 3/8" BSP



## PCL Filter / Regulator AFR1

Comes ready constructed so you can simply "connect and go"

### Features

- Polycarbonate bowls
- Semi-automatic drain valve
- Comes complete with mounting bracket and gauge
- Maximum Inlet Pressure - 10 bar
- Port Size - 1/2"
- Filter - 40 micron
- Gauge - 0-150 psi / 0-10 bar



## PCL Filter Regulator & Lubricator AFRLC1

Comes ready constructed so you can simply "connect and go"

### Features

- Polycarbonate bowls
- Semi-automatic drain valve
- Comes complete with mounting bracket and gauge
- Maximum Inlet Pressure - 10 bar
- Port Size - 1/2"
- Filter - 40 micron
- Gauge - 0-150 psi / 0-10 bar
- Capacity of oil bowl - 110 ml



## PCL Flexible Elbow 1/4" BSP PC101

A flexible connection used to eliminate hose kinks

### Features

- Corrosive-resistant plated Flexible Elbow
- Hardened Steel



## PCL Premium Spray Gun Suction - 1.7mm fluid nozzle - 1 litre aluminium cup - Air consumption - 6.0 cfm ASG01P

This Spray Gun offers the user high transfer efficiency to provide a premium quality paint finish

### Features

- Suitable for water based paints
- Brass air cap
- 1.7mm Stainless steel fluid nozzle and needle
- 1 litre aluminium cup
- Air Consumption - 6 cfm
- Working Pressure - 50 psi



**PCL Premium Spray Gun Gravity - 1.4mm fluid nozzle - 0.6 litre plastic cup - - Air consumption - 5.5 cfm**  
**ASG02P**

This Spray Gun offers the user high transfer efficiency to provide a premium quality paint finish

**Features**

- Suitable for water based paints
- Brass air cap
- 1.4mm Stainless steel fluid nozzle and needle
- 0.6 litre plastic cup
- Air Consumption - 5.5 cfm
- Working Pressure - 50 psi



**PCL Tail 9.5mm R 1/4" BSP (5)**  
**PC1226**

Hose Tail Adaptor/Connector

**Features**

- Coned Tailpiece
- Union Nut
- Hardened Steel with corrosive-resistant plating
- Female Thread - Rp 1/4
- Hose Internal diameter - 9.5mm / 3/8"



**PCL Standard Male**

Suitable for most compressed air applications  
For use with Airflow and Vertex Couplings

**Features**

- Used in most workshop/garage environments
- Also used with Twin, non-corrodible and Safeflow Safety couplings
- Case hardened for longer life
- Nominal Bore - 4.8 mm

Part No.	Description
PC2593	Std 1/4" BSPM (5)
PC6909	Std 3/8" BSPM (5)



**PCL Airflow**

Original quick-release coupling for fixed applications

**Features**

- Compatible with the Standard Adaptor range
- Steel Construction
- Robust and hardwearing
- Ideal for use in the engineering/workshop environment
- Positive locking mechanism
- Nominal Bore - 4.8 mm
- Maximum Flow Rate - 43 cfm (at 100 psi supply)
- Maximum Working Pressure - 200 psi / 14 bar

Part No.	Description
PC21CF	Airflow Rp 1/4" Female
PC21CM	Airflow R 1/4" Male
PC21EF	Airflow Rp 3/8" Female
PC21EM	Airflow R 3/8" Male
PC21JF	Airflow Rp 1/2" Female
PC21JM	Airflow R 1/2" Male
PC21R	Airflow 7mm Tailpiece
PC21S	Airflow 8mm Tailpiece
PC21T	Airflow 10mm Tailpiece



**PCL Standard + Tailpiece**

Suitable for most compressed air applications  
For use with Airflow and Vertex Couplings

**Features**

- Used in most workshop/garage environments
- Also used with Twin, non-corrodible and Safeflow Safety couplings
- Case hardened for longer life
- Nominal Bore - 4.8 mm

Part No.	Description
PC2486	Std 4.75mm Hose Tail (5)
PC1793	Std 6.35mm Hose Tail (5)
PC2487	Std 7.9mm Hose Tail (5)
PC2488	Std 9.5mm Hose Tail (5)



**PCL Standard Female**

Suitable for most compressed air applications  
For use with Airflow and Vertex Couplings

**Features**

- Used in most workshop/garage environments
- Also used with Twin, non-corrodible and Safeflow Safety couplings
- Case hardened for longer life
- Nominal Bore - 4.8 mm

Part No.	Description
PC2746	Std 1/4" BSPF (5)
PC6582	Std Adaptor 3/8" BSPF (3)





## PCL Tailpiece Connector/Repairer

Hose Connector for connecting or repairing hose sections

### Features

- Corrosive-resistant plated hose connector
- Hardened Steel

Part No.	Description
PC2983	d/e Repairer 6.35mm Hose (5)
PC2984	d/e Repairer 7.9mm Hose (5)
PC2985	d/e Repairer 9.5mm Hose (3)
PC2986	d/e Repairer 12.7mm Hose (2)



## PCL Tailpiece + BSP

Connects hose to a female fitting

### Features

- Corrosive-resistant plated
- Hardened Steel

Part No.	Description
PC5656	Tail 6.35mm R1/4" (5)
PC1206	Tail 7.9mm R1/4" (5)
PC1217	Tail 9.5mm R1/4" (5)
PC2479	Tail 12.7mm R1/4" (5)
PC6904	Tail 6.35mm R3/8" (3)
PC6905	Tail 7.9mm R3/8" (3)
PC2951	Tail 9.5mm R3/8" (3)
PC2808	Tail 12.7mm R3/8" (3)
PC2954	Tail 12.7mm R1/2" (3)

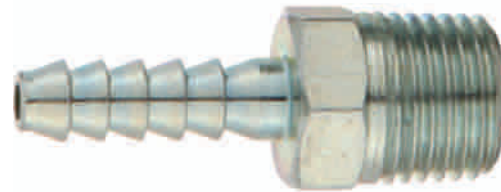

## PCL Y Connector Female Thread

For splitting a single connection into two

### Features

- Long life and durability

Part No.	Description
PC4279	Y piece 1/4" BSP Rp (2)
PC4280	Y piece 3/8" BSP Rp (1)



## PCL Series 100

Offers greater airflow characteristics so are ideal for the larger air tool in garage and tyre shop environments

### Features

- Hardened steel shoulder prevents accidental disconnection
- Swivel feature prevents kinking of the hose
- Specially designed valves and large aperture provides optimum air flow
- For use with 100 Series Couplings
- Corrosive resistant finish

Part No.	Description
PC5JF	Series 100 1/2" BSPT
PC5JM	Series 100 1/2" BSPT
PC3035	Series 100 1/2" BSPT Adaptor
PC3036	Series 100 + 1/2" Tailpiece



## PCL Double Unions

Double Union Male Thread for connecting fittings

### Features

- Corrosive-resistant plated
- Hardened Steel

Part No.	Description
PC6560	d/e Union R1/4" (5)
PC4281	d/e Union R3/8" (3)
PC6898	d/e Union R1/2" (2)

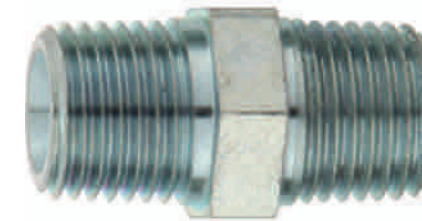

## PCL Reducing/Increasing Bushes

Reducing Bush for connecting differing pipe diameters (male to female)

Increasing Bush for connecting differing pipe diameters (male to female)

### Features

- Corrosive-resistant plated
- Hardened Steel

Part No.	Description
PC6895	R/Bush R3/8 X Rp1/4 (3)
PC6896	R/Bush R1/2 X Rp1/4 (3)
PC6897	R/Bush R1/2 X Rp3/8 (3)
PC6475	I/Bush 3/8"R (F) x 1/4"Rp(M) (3)



## PCL Reducing Bush / Parallel Socket

Parallel Socket for straight connections

Reducing Bush for connecting differing pipe diameters (female to female)

### Features

- Corrosive-resistant plated
- Hardened Steel

Part No.	Description
PC6889	1/4" BSPT Parallel Socket (3)
PC6892	Rp 3/8" BSPT x Rp 1/4" BSPT (3)
PC6893	Rp 1/2" BSPT x Rp 1/4" BSPT (2)



## PCL Unions

Reducing Union for connecting fittings

### Features

- Corrosive-resistant plated
- Hardened Steel

Part No.	Description
PC6899	R/Union R3/8 X R1/4 (3)
PC6900	R/Union R1/2 X R1/4 (3)
PC6901	R/Union R1/2 X R3/8 (3)



## PCL Safeflow

Ideal for engineering and workshop environments Safeflow Couplings offer maximum safety and highest quality

### Features

- Two stage self-venting release
- Creates a safe compressed air environment
- Compatible with genuine PCL standard adaptors
- Safe and simple to use
- Best practice for compressed air users
- Enhances workshop safety - prevents hose whip
- A robust, steel construction, with corrosive resistance finish
- Manufactured in accordance with safety standard ISO 4414:2010
- Maximum working pressure 200 PSI / 14 BAR

Part No.	Description
PCS21F	1/4BSP Female Safeflow
PCS21M	1/4BSP Male Safeflow



## PCL XF Couplings and Adaptors

Offers increased airflow for enhanced tool efficiency

Adaptors are designed for use with XF couplings

### Features

- High flow rate - 130 cfm @ 100 psi
- Steel construction with corrosive resistant finish
- Steel shoulder prevents accidental disconnection
- Case hardened for longer life



Part No.	Description
PC71CF	XF Coupling 1/4" BSPF
PC71CM	XF Coupling 1/4" BSPM
PC71EF	XF Coupling 3/8" BSPF
PC71EM	XF Coupling 3/8" BSPM
PC7102	XF Adaptor 1/4" BSPM (3)
PC7103	XF Adaptor 3/8" BSPM (3)
PC7106	XF Adaptor 1/4" BSPF (3)
PC7112	XF Adaptor 1/4" BSP Tail (3)



## PCL Vertex

Less likely to become disconnected when used in trailing hose applications in garages and workshops

Ideal for trailing hose applications in garage and tyreshop environments

### Features

- Compatible with the Standard Adaptor range
- Protective shoulder prevents dirt penetration and accidental disconnection
- Steel Construction - robust and hardwearing
- Positive locking mechanism
- Nominal Bore - 4.8 mm
- Maximum Flow Rate - 43 cfm (at 100 psi supply)
- Maximum Working Pressure - 200 psi / 14 bar



Part No.	Description
PC91CF	Vertex Female Rp 1/4"
PC91CM	Vertex Male R 1/4"
PC91EF	Vertex Rp3/8 Female
PC91EM	Vertex R3/8 Male
PC91JF	Vertex Rp1/2 Female
PC91JM	Vertex R1/2 Male
PC91R	Vertex 7mm Tailpiece
PC91S	Vertex 8mm Tailpiece
PC91T	Vertex 10mm Tailpiece





# Power Tools - M

## Contents

Ingersoll Rand	M2
AC Delco	M3
Batteries & Chargers	M8

**FF Franklin & Co Ltd**

Platt Street

Sheffield

S3 8BQ

England

**Telephone**

0114 272 1429

**Facsimile**

0114 272 7030

**Email**

orders@franklin-tools.co.uk

# 2020

[www.franklin-tools.co.uk](http://www.franklin-tools.co.uk)

## IR Impact Wrench W5132-K22 3/8" dr Kit 745Nm JW5132

High-Torque Compact Impact Wrench is perfect for vehicle repair and MRO applications

### Features

- 3/8" Drive
- Forward Torque - 400-460Nm (295-340ft/lbs),
- Nut-Busting Torque - 540/745 (400/550ft/lbs)
- Limited Torque - For tyre & wheel installation
- Built-in 360 Degree Shadowless LED lights
- Delivering more torque, durability, and efficiency
- 4 Power modes: Max, Mid, Wrench Tight and Hand Tight
- Chemical-resistant housing
- Comes with 1 x 20v 2.5Ah Battery, 1 x 20v 5Ah Battery, Charger and T
- 3-year warranty



3/8"

## IR Impact Wrench W5152-K22 1/2" dr Kit 745Nm JW5152

High-Torque Compact Impact Wrench is perfect for vehicle repair and MRO applications

### Features

- 1/2" Drive
- Forward Torque - 400-460Nm (295-340ft/lbs)
- Nut-Busting Torque - 540/745 (400/550ft/lbs)
- Limited Torque - For tyre & wheel installation
- Built-in 360 Degree Shadowless LED lights
- Delivering more torque, durability, and efficiency
- 4 Power modes: Max, Mid, Wrench Tight and Hand Tight
- Chemical-resistant housing protects against repeated drops and exposure to shop fluids
- Comes with 1 x 20v 2.5Ah Battery, 1 x 20v 5Ah Battery, Charger and
- 3-year warranty



1/2"

## IR Impact Wrench W7152-K22 1/2" dr Kit 2040Nm JW7152

The JW7152 is the most powerful cordless impact wrench in its class

### Features

- 1/2"dr Square, Socket Retainer Ring
- Variable-speed switch with electronic brake provides maximum control
- Nut Busting Torque - 2040Nm (1500 ft-lb), Forward Torque - 1360Nm (1000 ft-lb)
- Maximum Reverse Torque - 1360Nm (1000 ft-lb), Blows per Minute 2450
- Free Speed - 1900rpm, Weight (with battery) 3.4kg (7.6lb)
- IQV Power Control System with 4 modes: Full Power, Half Power, Wrench Tight, and Hand Tight
- 360 degree shadowless task light provides increased visibility and access
- 4 dimmable settings on the shadowless 360 degree LED light ring
- Comes with 2 x BL2022 Batteries, Charger and Carry Bag
- 3-year warranty



1/2"

## AC Delco ARI1268-3AEU 10.8v 3/8"dr Impact Wrench Kit 248Nm R1268A

Li-ion 10.8v 3/8" Impact Wrench

### Features

- 10.8v - 3/8" Sq dr
- Max. Reverse Torque - 248 Nm (182 ft-lbs)
- Max Tightening Torque - 160 Nm (118 ft-lbs)
- No Load Speed - 0-2,300 RPM, Weight - 1.22 kg (2.28 lbs)
- Battery indicator shows battery status
- Built-in LED light
- With free Wrench to Driver Adaptor
- 2 x 2.0Ah Batteries (Re-Order Code - RB1242)
- 1 x Charger and Carry Case
- 3 Year Warranty Only on Tool and Batteries
- 1242 Series



3/8"

## AC Delco ARI2068 -3AEU 18v 3/8"dr Impact Wrench Kit 280Nm R2068A

Li-ion 18v 3/8" Impact Wrench / Driver

### Features

- 18v - 3/8" Sq dr
- Max. Reverse Torque - 280 Nm (2,480 in-lbs)
- Max Tightening Torque - 180 Nm (1,595 in-lbs)
- No Load Speed - 0-2,000 RPM, Weight - 1.25 kg (2.75 lbs)
- Variable speed with reversible control
- Built-in LED light, Battery indicator shows battery status
- 2 x 2.0Ah Batteries (Re-Order Code RB2042)
- With free Wrench to Driver Adaptor
- Also included - charger x1 and carrying case x1
- 3 Year Warranty Only on Tool and Batteries
- 2042 Series



3/8"

## AC Delco ARD2082BEU 18v Jumbo Drill Kit 50Nm R2082B

18V Li-ion 2-Speed Drill / Driver 50Nm

### Features

- Max. Torque - 50 Nm (37 ft-lbs)
- 2-Speed Gearbox
- Torque Adjustment Collar
- 20 Torque Settings and Drill Mode
- Incorporated Super Bright LED
- Battery Indicator
- Anti-Slip and Fatigue-Free Soft Grip
- 2 x 4Ah batteries included (Re-Order Code RB20274)
- Chuck Capacity - 13MM
- No Load Speed - 0-450 / 0-1,600 RPM
- Tool Weight- 1.82 kg
- 3 Year Warranty Only on Tool and Batteries
- 2027 Series





## AC Delco ARD2082T 18v Jumbo Drill 50Nm - Bare Tool R2082T

18V Li-ion 2-Speed Drill / Driver 50Nm - Bare Tool

### Features

- Max. Torque – 50 Nm (37 ft-lbs)
- 2-Speed Gearbox
- Torque Adjustment Collar
- 20 Torque Settings and Drill Mode
- Incorporated Super Bright LED
- Battery Indicator
- Anti-Slip and Fatigue-Free Soft Grip
- Chuck Capacity – 13MM
- No Load Speed – 0-450 / 0-1,600 RPM
- Tool Weight- 1.82 kg
- 3 Year Warranty Only on Tool
- 2027 Series



ACDelco

## AC Delco ARI2094-3AEU 18v 3/8"dr Impact Wrench Kit 400Nm R2094A

Li-ion 18v 3/8" Impact Wrench / Driver

### Features

- 18v - 3/8" Sq dr
- Max. Reverse Torque - 400 Nm (300 ft-lbs)
- Max Tightening Torque - 260 Nm (190 ft-lbs)
- No Load Speed - 0-2,000 RPM
- Weight - 1.89 kg (4.16 lbs)
- Battery indicator shows battery status
- Built-in LED light
- With free Wrench to Driver Adaptor
- 2 x 4.0Ah Batteries (Re-Order Code RB20274)
- Also included - charger x1 and carrying case x1
- 3 Year Warranty Only on Tool and Batteries
- 2027 Series



ACDelco

3/8"

## AC Delco 9pce Multi-Kit 10.8v R3MULT

Cordless 10.8v Multi-Tool Kit

### Features

- 10.8v 3/8" 2-Speed Drill (34Nm)
- 10.8v 3/8" Impact Wrench (280Nm)
- 10.8v 1/4" Impact Driver (140Nm)
- 10.8v Light Bar (run time 8hr) - 1 Year Warranty
- 3 x 2Ah Batteries (Re-Order Code RB1242)
- 10.8v Battery Charger
- Blow Moulded Case, Quality Canvas Bag
- 3 Year Warranty Only on Tools and Batteries
- 1242 Series



ACDelco

1/4" 3/8"

## AC Delco 5pce Multi-Kit 7.2v R5MULT

Cordless 7.2v Compact Multi-Tool Kit

### Features

- 7.2v 1/4" Ratchet Wrench Kit (39Nm)
- 7.2v 6mm Drill (5 Torque Settings)
- 7.2v LED Flashlight (8hrs Run Time) - 1 Year Warranty
- 7.2v 3/8" Impact Wrench (155Nm)
- 7.2v Impact Driver (2600 RPM)
- 7.2v Drill Driver (5 Torque Settings and Drill Mode)
- 4 x 2Ah Batteries (Re-Order Code RB854)
- Single and Double Port Chargers
- Canvas Tool Bag
- Blow Moulded Case
- 3 Year Warranty Only on Tools and Batteries
- 854 Series



ACDelco

1/4" 3/8"

## AC Delco ARI20119AEU 1/2"dr 18v Impact Wrench Kit 1200Nm R2119A

18V Li-ion Impact Wrench 1200Nm

### Features

- Max. Reverse Torque – 1200Nm (885 ft/lbs)
- Max. Tightening Torque – 800Nm (590 ft/lbs)
- Durable Metal Gearbox Housing, 4-POLE-EX High Torque Motor
- Battery Indicator
- Incorporated Super Bright LED
- 2 x 4Ah batteries included (Re-Order Code RB2047)
- No Load Speed – 0-1,700 RPM, Impacts per Minute – 0-2,200 IPM
- Tool Weight – 3.20 kg (7.04 lbs)
- 3 Year Warranty Only on Tool and Batteries
- 2027 Series



ACDelco

1/2"

## AC Delco ARW804AEU 1/4" dr Ratchet Kit 37Nm R804AE

Compact and lightweight for those hard to reach areas

### Features

- Angled compact head for use in narrow spaces
- 37Nm (27ft/lbs)
- Anti-slip soft grip
- No load speed 200 RPM
- Safety lock design, Built-in LED light
- 2 x 2.0Ah Batteries included (Re-Order Code RB854)
- Single port charger
- Weight - 0.73kg
- Supplied in a Canvas pouch bag
- 3 Year Warranty Only on Tool and Batteries
- 854 Series



ACDelco

1/4"

## AC Delco ARW1208AEU 10.8v 3/8"dr Ratchet Wrench Kit 75Nm R1208A

10.8V Li-ion 3/8" Ratchet Wrench 75Nm

### Features

- Max. Torque – 75 Nm (55 ft-lbs)
- Durable metal gearbox housing, Anti-slip soft grip
- Variable speed switch
- Angled compact head for use in narrow spaces
- 2 x 2.0Ah Li-ion battery (Re-order Code - RB1207)
- 1 x Charger, 1 x Carrying Case
- 3/8" Square Drive
- No Load Speed – 0-170 RPM, Tool Weight – 1.40 kg (3.0 lbs)
- 3 Year Warranty Only on Tool and Batteries- No Registration Needed
- G12 Series

3/8"



ACDelco



## AC Delco ARZ6056EU 6v Inspection Camera Kit R6056E

Multi-Media Inspection Camera for video recording with voice annotation

### Features

- Can review images and video directly on device
- 5.5 mm Camera Head, 3" Color LCD HD display
- Resolution – 320 x 240
- Full Run Time – Up to 5 hours
- 4GB SD Memory card included
- USB Output for transferring video and images to a PC.
- 4 built-in LEDs on camera probe with 5 settings of brightness
- 110° Viewing Angle and 180° Flip
- Anti-slip soft grip.
- 48" Waterproof Flexible Cable, 6V Alkaline-Battery
- Tool Weight – 1.50 lbs (0.68 kg)
- 1 Year Warranty
- \* Also Compatible With 10.8v Rechargeable Batteries
- \*\* 10.8v Rechargeable Battery and Charger Included



ACDelco



## AC Delco ARG2019AEU 4.5" Brushless Angle Grinder Kit RG219A

18V 4-1/2" Brushless Angle Grinder

### Features

- Lock-on side switch for comfort during extended use
- Spindle lock button for easy grinding disc change
- Three-position side handle
- Battery indicator, Disk Size - 4-1/2" (115mm)
- Spindle Thread - M14, No Load Speed - 8,500 RPM
- Tool Weight - 5.06 lbs (2.30 kg)
- Includes: 2 x 4Ah Batteries (Re-Order Code RB20274)
- Charger and Tool Bag
- 3 Year Warranty Only on Tool and Batteries
- 2027 Series

Part No.	Description
RG219T	Angle Grinder Bare Tool Only



ACDelco



## AC Delco ARG1207AEU 10.8v Rotary Tool Smart Repair Kit RG1207

10.8v Rotary Tool - Good for Window/Glass/Windshield Repair and Alloy Wheel Refurbishment

### Accessories

- 4pcs Collet
- Collet Nut
- Axial Brass Brush
- Radial Bristle Brush
- 2pcs Screw Mandrel
- Drum Sander
- 5pcs Sander Band
- 40pcs Sanding Discs
- Wrench
- Accessory Box
- Sanding Disc Can

### Features

- Collet Capacity - 0.79mm (1/32"), 1.59mm (1/16"), 2.38mm (3/32"), 3.18mm (1/8")
- No Load Speed: 5000 - 35000 RPM
- Tool Weight 0.45kg (0.99lbs)
- Speed Memory Function, Safety Lock Off Function
- Hook for easy hanging
- 2 x 2Ah Batteries (Re-Order Code RB1242)
- Digital LCD Panel control shows speed settings and battery capacity
- 3 Year Warranty Only on Tool and Batteries
- 1242 Series



ACDelco



## AC Delco ARS1214FAO Polisher/Sander Kit 10.8v RS214F

10.8V 2 Speed 75mm Dual Action Mini Polisher/Sander

### Features

- Anti-Slip Soft Grip
- 2-Speed Gearbox
- Orbital Attachment
- Two position side handle for easy operation
- No Load Speed – 0-2,800 RPM 0-7,600 RPM
- Tool Weight – 0.88 kg (1.93 lbs)
- 1 x 4.0Ah and 1 x 2.0Ah Batteries supplied (Re-Order Codes RB1207, RB1212)
- 10.8v Battery Charger
- Blow Moulded Case
- 3 Year Warranty Only on Tool and Batteries
- G12 Series



ACDelco





## AC Delco Batteries and Chargers

### Series 2027

- RB2027 - 2027 Series AB2027LA 18v 2.0Ah Battery
- RB2047 - 2027 Series AB2027LA-2 18v 4.0Ah Battery
- RC2027 - 2027 Series ADC20EU28-30A 18v Charger

### Series 2042

- RB2042 - 2042 Series AB2042LA 18v 2.0Ah Battery
- RC2042 - 2042 Series ADC20EU40-15 18v Charger

### Series 1207

- RB1207 - G12 Series AB1207LA 10.8v 2.0Ah Battery
- RB1212 - G12 Series AB1212LA-2 10.8v 4.0Ah Battery
- RCG12 - G12 Series ADC12EU07-40 10.8v Charger

### Series 1242

- RB1242 - 1242 Series AB1242LA 10.8v 2.0Ah Battery
- RC1242 - 1242 Series ADC20UN40-15A 10.8v Charger

### Series 854

- RB854 - 854 Series AB854LA 7.2v 2.0Ah Battery
- RC854 - 854 Series ADC8EU50-30 7.2v Charger

Part No.	Description
RB2027	2027 Series AB2027LA 18v 2.0Ah Battery
RB2047	2027 Series AB2027LA-2 18v 4.0Ah Battery
RC2027	2027 Series ADC20EU28-30A 18v Charger
RB1207	G12 Series AB1207LA 10.8v 2.0Ah Battery
RB1212	G12 Series AB1212LA-2 10.8v 4.0Ah Battery
RCG12	G12 Series ADC12EU07-40 10.8v Charger
RB2042	2042 Series AB2042LA 18v 2.0Ah Battery
RC2042	2042 Series ADC20EU40-15 18v Charger
RB1242	1242 Series AB1242LA 10.8v 2.0Ah Battery
RC1242	1242 Series ADC20UN40-15A 10.8v Charger
RB854	854 Series AB854LA 7.2v 2.0Ah Battery
RC854	854 Series ADC8EU50-30 7.2v Charger



**ACDelco**

## Ingersoll Rand Batteries & Chargers

### JBC112 - Battery Charger 12v/20v

- Multi-use battery charger. For use with any of our IQV12 and IQV20 Lithium-Ion Batteries
- Charge any of the IQV12 and IQV20 Series batteries (12V or 20V) on the same universal charger
- Audible alarm will let you know when your batteries are fully charged
- Can be mounted vertically or horizontally on a wall or work bench

### BL2012 - 20V Lithium-Ion Battery IQV20 Series

- The 2.5Ah battery delivers a longer run time than its predecessor
- Slim design

### BL2022 - 20V Lithium-Ion Battery IQV20 Series

- High Capacity 5.0Ah battery delivers a longer run time than its predecessor
- BL2022 5.0Ah battery is compatible with all IQV20 series power tools

Part No.	Description
JBC112	Battery Charger 12v/20v
JB2012	20V Lithium-Ion Battery IQV20 Series
JB2022	20V Lithium-Ion Battery IQV20 Series



**IR**  
Ingersoll Rand

# Test Tools - N

## Contents

Electrical & Battery Testing

N2

Fuel Test

N6

**FF Franklin & Co Ltd**

Platt Street

Sheffield

S3 8BQ

England

**Telephone**

0114 272 1429

**Facsimile**

0114 272 7030

**Email**

orders@franklin-tools.co.uk

# 2020

[www.franklin-tools.co.uk](http://www.franklin-tools.co.uk)





**Power Probe Automotive Test Meter  
BPATM**

Designed for automotive electrical circuit's trouble shooting  
Suitable for 6v 12v and 24v Vehicles

**Measures**

- Mini ATM Fuse: 3A to 30A max
- Standard ATC Fuse: 3A to 40A max
- Maxi Fuse: 20A to 80A max
- Voltage (max. 50VDC)
- Parasitic Drain
- Test range 1mA~999mA max
- Test range 2.00A~30.00A max
- Cranking Volts with auto HOLD function
- Resistance [Ohms] (from 0.0 Ω up to 1.0 MΩ)
- Frequency with peak to peak volts (up to 20 KHz)



POWER PROBE

**Power Probe Ultra Probe  
BUPKIT**

Multiple testers at your fingertips

- Volt Meter
- Short Circuit Indicator
- 6M Power Cable and 6M Extension Cable
- Bad Ground Indicator
- Continuity Tester
- Test Light
- Relay Tester

**Features**

- Power Input: DC 12V or 24V Battery
- DCV Measurement Range: 0.00V to 70.00V maximum
- Resistance Measurement Range: 1 W to 2KW (2,000W) maximum
- Frequency (Hz) Measurement Range: 0Hz to 99,999 Hz at greater than 2.0 V (max)
- Peak to Peak Voltage Measurement: High Peak Volts, Low Peak Volts and Average
- Over Load Protection: 8.0 Amps [Manual RESET] Circuit Breaker
- Reverse Polarity Protection: Probe will not power ON when connected in reverse



POWER PROBE

**Power Probe Sensor Test Lead Kit  
BPSTLK**

48 piece Kit for quick and easy Diagnosis of faults on most sensors/ valves/ solenoids/ actuators/ Injectors/ starter circuit/ ignition coil, etc.

Designed to work with diagnostic scopes and Power Probes

**Kit Includes**

**Features**

- 33 Y connectors various sizes
- Acicular Probe Red
- Acicular Probe Black
- Piercing Probe
- Enhanced Variable resistor w/ Dial Indicator
- Airbag/SRS Simulator
- Stackable Banana Cable 2 x Red 2 x Black
- Banana Cable 1 x Red 1 x Black



POWER PROBE

**Power Probe Diagnostic Break Out Box  
BPECB**

Can Bus Circuit Tester compatible with 12v and 24v systems

**Features**

- Test all 16 pins in the OBD port
- Test for power supply and grounds in OBD port
- Test Individual Pin Voltage
- Detects Live Communication Protocol Signals
- Low Voltage Alarm
- 2mm female connection
- Comes with 2 x 2mm male to 4mm female adaptors



POWER PROBE

## Pro Digital Multimeter AMT32

A.C. volts 2v 20v 200v 600v, A.C. amps 2mA - 10A  
D.C. volts 200mV 2V 20V 200V 600V  
D.C. amps 2000, 20m, 200m, 10A  
Resistance 200, 2K, 20K, 200K, 2M 20M ohms

### Features

- Clear digital display
- 32 position rotary selector
- Automatic polarity indicator
- Audible continuity test
- Reading holder
- CE approved EN61010-1:2010
- NPN and PNP Transistor gain hFE
- Diode test
- Rubber shroud
- 9v battery
- Test leads and MF socket
- Supplied in a sturdy plastic case
- Battery and instruction manual included



## Power Probe Magnetic Fuse Tester BFUSET

Compatible with most multi meter 4mm leads and works by attaching to each other via magnets giving you the facility to test the three main types of fuses: Mini, ATC, Maxi

### Features

- Side A-A match mini fuse size
- Side A-B / B-A ATC fuse size
- Side B-B match maxi Fuse Size
- Fuse probing can be done by one handed operation
- Can be used as a single probe



## Franklin Accelerator/Brake Pedal Tool TA327

Allows the pedals to be precisely held in position

### Features

- Speed can be accurately maintained for testing
- Allows one-man brake bleeding operations

**KEEP IN NEUTRAL GEAR WITH HANDBRAKE ON  
ALWAYS WORK IN A WELL VENTILATED AREA**



## Franklin Heavy Duty Circuit Tester TA194

For testing low voltage vehicle circuits

### Features

- 6-24v range
- 90mm piercing blade
- 1.5m insulated lead
- Heavy duty shrouded clip



## Franklin Brass Circuit Tester 115mm 4588

Automotive tester for locating short circuits, faulty lights and blown fuses

### Features

- 115mm with piercing blade
- Range : 6-24 volts
- Comes with cable and crocodile clip



## Franklin Automotive Relay Tester 12v A31012

A quick go/no-go tester for automotive relays

### Features

- Tests 3 most popular 4 / 5 pin electro-mechanical relays used on current cars with 12v systems
  - Coil resistance 20-50 Ohms - threshold 200 milli-ohms
  - 12 month warranty excludes blown fuses
  - Colour coded pass/fail test result
  - Leads and colour coded alligator clips provided
- ONLY FOR USE WITH 12 VOLT SYSTEMS  
NOT SUITABLE FOR USE ON INVERTED RELAYS**



## Franklin Terminal Circuit Tester Kit DC AT1780

Wiring circuit checking tool External/Internal

Designed to test the circuit without damaging the connector

### Features

- High impedance to protect sensitive electronic sensors, micro-processors, electronic ignition components and air bags
- 14 pce Terminal Kit 0.8 1.2 2.0 2.5 3.0 5.0 6.0 mm male & female for Weather-Pack Metri-Pack Mic-Pack style terminals
- Banana Socket - Testing Needle - Alligator Clips
- Not suitable for A/C
- 6-24v DC Circuit Tester with 6 ft cable
- Plastic storage case



## Franklin Polarity Circuit Tester TA199

Probe tool allows continuity and polarity tests to be carried out

### Features

- 6-24v range
- 80mm piercing blade
- 1.5m insulated lead
- Heavy duty shrouded clip
- Red / Green LED's show polarity



## Franklin Automotive Surge Protector 12/24v AS1224

Voltage surges that cannot be absorbed through the battery can cause damage during jump starts welding and other maintenance work

### Features

- Increased protection against voltage surges
- Simple to use
- LED's indicate correct function
- MAXIMUM VOLTAGE 44v DC





## Franklin 3pce Fuel Coupling Plier Set TA660

For quick release fittings on fuel lines  
Citroen Fiat Ford GM/Opel/Vauxhall PSA Renault etc

### Features

- Plastic Dipped Handles For Comfort and Grip
- Colour coded handles and laser etched markings for easy identification
- Matt Black Finish

Part No.	Description
TA661	PSA 8mm
TA662	PSA 10mm
TA663	Fiat, Ford, GM



## Franklin Petrol Engine Compression Set AT6808

To quickly and accurately check compression on Petrol Engines  
M10 x 1.0, M12 x 1.25, M14 x 1.25, M18 x 1.50

### Features

- 300 psi gauge with quick release fittings
- 400mm flexible extension
- 2 push-on connectors straight and angled
- Pressure relief valve
- Tough Impact Resistant Carry Case



## Franklin Diesel Compression - Master Set AT6910

Supplied with a comprehensive set of dummy glowplug and injector adaptors to cover a wide range of popular automotive agricultural and marine applications

### Features

- 1000 psi pressure gauge
- Straight and right angled quick release fittings
- Injector : M20 M22 M24 and Ford Stanadyne
- Includes clamp-on injector adaptor set
- A range of Glow plug adaptors
- Tough Impact Resistant Carry Case



## Mityvac Petrol Engine Compression Test Kit AM5530

For use on dry and wet engine cylinder compression tests  
Not for use on diesel engines

### Features

- Manual pressure release for maintaining peak readings
- Professional grade threaded adapters for leak-proof seals
- Extended hoses for hard to reach applications
- Large, easy to read 2 3/4" (70 mm) diameter gauge
- Quick disconnect coupler for easy accessory changes
- Max. Pressure: 300Psi (21kg/cm2) (20.5 bar) (2.070 kPa)

### Includes

- 2 3/4" (70 mm) gauge with high impact lens, rubber boot, and four (4) scales of measure (psi, kg/cm2, bar, kPa), attached to 10" (250 mm) long hose and quick release coupler
- 14 mm short-thread adapter with 6 1/2" (165 mm) and 12" (305 mm) long hoses
- 14 mm long-thread adapter with 12" (305 mm) long hose
- 18 mm short-thread adapter with 12" (305 mm) long hose
- 14 mm short-thread x 18 mm long-thread adapter
- 10 mm thread small engine adapter
- 12 mm thread small engine adapter
- Quick release air hold adapter



## Mityvac Silverline Elite Auto Test Kit 0-60 psi / 0-30" HG AM8550

For testing automotive systems - manifold vacuum / advance - turbo wastegate  
- EGR valve - LDA diaphragm - brake servos etc + Prime a diesel filter

### Features

- 360 Degrees gauge rotation
- 480cc fluid bottle
- 12 vacuum caps
- Brake bleed adaptor kit
- Various other diagnostic adaptors / tubing
- 0-60 psi (4 bar) pressure - 0-30 "HG (-1 bar) vacuum
- Tough Impact Resistant Carry Case



## Franklin Pro Anti Freeze Tester Propylene TA168

For testing hot or cold Propylene Glycol based Automotive Anti-Freeze and Coolant

### Features

- Number of Discs Measures Level of Protection
- Always refer to your Workshop Manual to ensure the Correct Anti-Freeze Type and Mixture is Used
- Always use Approved Eye Protection
- Anti-Freeze is Poisonous
- Always Observe the Local Disposal Regulations - Do Not Use Drains



## Franklin Pro Anti Freeze Tester Ethylene TA167

For testing hot or cold Ethylene Glycol based Automotive Anti-Freeze and Coolant

### Features

- Number of Discs Measures Level of Protection
- The 6th Orange Disc denotes an Excessive Anti-Freeze Mixture (Greater than 70%) This Reduces both the Cooling Efficiency and Level of Corrosion Protection
- Always refer to your Workshop Manual to ensure the Correct Anti-Freeze Type and Mixture is Used
- Always use Approved Eye Protection
- Anti-Freeze is Poisonous
- Always Observe the Local Disposal Regulations - Do Not Use Drains



## ZECA Cooling System Tester AZ415

For pressure testing the cooling system of cars

### Features

- Long, flexible extension for difficult to reach radiators with pressure release valve
- Quick coupler system
- Enables the user to determine immediately any leak in the cooling system and any incidental failures:

- faulty or worn hoses
- loose jubilee clips
- radiator leaks
- faulty cooling circuit
- burnt or badly seated cylinder head gaskets
- Tough Impact Resistant Carry Case

### Supplied adaptors

416.05 FCA GROUP - PSA - RENAULT - NISSAN - MINI - VOLVO - ROVER - MASERATI

416.10 VW GROUP - FORD - OPEL - SAAB - CHEVROLET

416.24 BMW

416.30 FCA GROUP - OPEL - SAAB

416.35 VW GROUP - PORSCHE

416.40 FORD

416.45 MERCEDES

416.55 SMART - PORSCHE

416.65 MERCEDES

416.70 FIAT - SUZUKI - TOYOTA - MITSUBISHI

416.80 MAZDA - FORD - VOLVO

416.85 BMW

Part No.	Description
AZ416	Pump Unit
AZ4166	Land Rover Adaptor
AZ4181	Mercedes Adaptor
AZ4.35	M62 Cap Late VAG





# Powertrain -

## Contents

Engine	02
Filter Tools	09
Fluid Transfer	014
Cooling System	019
Exhaust	021

**FF Franklin & Co Ltd**

Platt Street

Sheffield

S3 8BQ

England

**Telephone**

0114 272 1429

**Facsimile**

0114 272 7030

**Email**

[orders@franklin-tools.co.uk](mailto:orders@franklin-tools.co.uk)

# 2020

[www.franklin-tools.co.uk](http://www.franklin-tools.co.uk)



**Franklin Piston Ring Compressor TA112**

Suitable for Most Car and Light Commercial Engines

**Features**

- Capacity 53-175mm diameter x 75mm deep
- Quality Steel Spring Bands
- Ratchet action with thumb lever release
- 1/4" square drive adjustment key



1/4"



**Franklin Valve Spring Compressor Multi-Valve TA900**

This Tool Is Designed By Franklin Tools For Use On Multi-Valve Petrol And Diesel Engines With Deep Seated Valves.

It Is Also Suitable For General Use On Many OHV and OHC Petrol And Diesel Engines.

The Unique Dual Cam Action Provides A Choice Of Operation From Either Above Or Below The Valve To Give Improved Access Which Often Allows Several Valves To Be Serviced Without The Need To Re-Position The Cylinder Head.

The Reversible Jaw Adaptor Enables The Tool To Be Used On A Wide Range Of Engines

**Features**

- Capacity 55-175mm
- Throat Clearance 165mm
- For Multi-Valve petrol and diesel engines



**Franklin Stud & Bolt Extractor 6-12mm 1/2" dr TA221**

Fully Adjustable Stud & Bolt Extractor

**Features**

- Chro-Mo Steel
- Range 6 - 12mm diameter



1/2"



**Franklin Spark Plug Sockets**

For Spark Plug Fitting / Extraction

**Features**

- Chrome Vanadium Steel
- Mirror Finish
- Anti-Slip Knurl
- Rubber Insert

Part No.	Description
FT3807	M10 16mm 3/8" dr
FT1207	M10 16mm 1/2" dr
FT3808	M14 21mm 3/8" dr
FT1208	M14 21mm 1/2" dr



3/8"

1/2"



**Franklin Adjustable Cylinder Hone 2-7" TA140**

Supplied with 4" medium grade stones

**Features**

- Allows Use Without Removing Cylinder
- Capacity 50-180mm (2-7") bore diameter
- Flexible Self-Aligning Shaft
- Spring Tension Adjustment
- For use with an Electric Drill or Airtool

Part No.	Description
TA143	3 Replacement Stones (TA140)



**Franklin 4 pce Valve Collet Pick Up Set TA324**

Three installing tools with a range of jaw capacities to suit different collet sizes

**Features**

- Flexible magnetic pick-up tool
- Tough Impact Resistant Carry Case



**Franklin 4 pce Stud Extractor Set 1/2" dr TA224**

6 8 10 12mm

Studs are Turned Evenly on a Central Axis Ensuring Less Chance of Breaking Old Rusted Studs

**Features**

- For Removal and Insertion of Studs
- Concentric Roller Action
- Chrome Vanadium Steel
- Anti-Slip Knurl
- Roll Marked Size For Easy Identification
- Tough Impact Resistant Carry Case

Part No.	Description
TA226	6mm
TA228	8mm
TA2210	10mm
TA2212	12mm



1/2"



**Franklin M8 14 x 65mm Thinwall Plug Socket 3/8" dr TA261**

Special Thin Wall 14mm Bi-Hex Spark Plug Socket

**Features**

- Spring Clip Plug Retention
- Chrome Vanadium Steel
- Renault Twingo Clio Kangoo 1.2 16v
- Citroen C5 2.0 HPI
- BMW E90 N54 335i
- Mercedes M156
- BMW Mini 1.4L and 1.6L Petrol Engines



3/8"





## Franklin Feeler Gauge

130C - 0.0015"-0.025"

### Features

- Imperial
- 10 blades x 100mm (4") long

Part No.	Description
130C	Imperial
132C	Metric
137	Metric/ Imperial (32)

132C - 0.05 - 0.80mm

### Features

- Metric
- 10 blades x 100mm (4") long

137 - 0.038-0.889mm 0.0015"-0.035"

### Features

- 32 Metric / Imperial Blades x 100mm (4") Long



## Franklin Wire Spark Plug Gap Gauge 0.4 - 2.0mm

136

0.4mm - 2.0mm (0.0015" - 0.080")

### Features

- Durable Plastic Body
- Raised Size Markings For Ease of Identification
- Metric and Imperial Size Markings

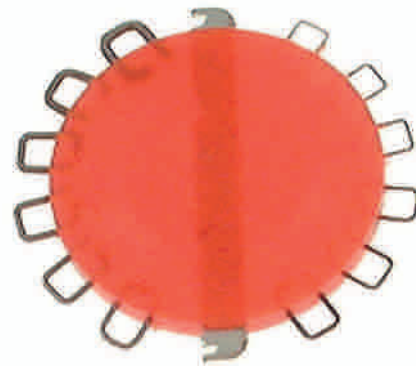

## Franklin Diesel Injector Puller Set - Bosch, Delphi, Denso & Siemens

AT2814

14 pce set - Suitable for a wide range of Bosch, Delphi, Denso and Siemens Diesel Injectors

### Features

- Supplied with various Adaptors for use with the 4kg Slide Hammer
- Additional Ball Joint Adaptor enables the Slide Hammer to be used where access is restricted
- Includes 4 x 1/2"dr Diesel Injector Sockets - 25, 27, 29, 30mm
- Tough Impact Resistant Carry Case



## Franklin 8 pce Diesel Injector Puller Set D-B & Mercedes

AT2808

D-B and Mercedes CDI Common Rail Engines

M17 Male x 1.0 Adaptor

M12 male x 1.75 Adaptor

M27 female x 1.0 Bosch Adaptor

### Features

- For removing seized Bosch/Delphi Diesel Injectors without removing the Cylinder Head
- 1.75 kg slide hammer x 350mm
- Tough Impact Resistant Carry Case



## Franklin 6 pce Diesel Injector Seat Cutter Set

AT6970

A Set of 4 Diesel Injector Seat Cleaners with Centering Pilot and T-Handle. Use to Clean / De-Carbonise Injector Seats when Changing Injectors. Helps to Avoid Blow-Back Problems Due to Poorly Seated Injectors.

### Features

- 17mm Flat Cutter with 19mm External Diameter
- Mercedes-Benz CRD 17mm Angled Cutter with 21mm External Diameter
- Fiat / Iveco 17mm Flat Cutter with 17mm External Diameter
- BMW / PSA / Renault 15mm Flat Cutter with 19mm External Diameter
- Tough Impact Resistant Carry Case

\*\*COMPATIBLE WITH OTHER MAKES\*\*



## Franklin Diesel Injector Puller Set - PSA

AT2806

Suitable for PSA 2.0 and 2.2 HDi injectors - DW10 DW12

### Features

- Puller Plate with 3 Legs
- Forcing Screw Nut
- Forcing Screws 17mm x 1.0 and 25mm x 1.0
- Injector Cap Sockets 25mm and 29mm
- Injector Key with Dual 21mm Hexagon 1/2" sq dr
- Bridge Piece helps to Prevent Damage to the Area Surrounding the Injector
- Allows the removal of seized Injector Nozzles without the need to remove the Cylinder Head



## Franklin 7 pce Diesel Injector Puller Set - VAG

AT2810

Suitable for VAG TDI PD diesel injectors

1.4 SDI/TDI - 1.9D/SDI/TDI (PD) - 2.0TDI (PD)

2.5 TDI - 2.5TDI (PD) - 2.8TDI (PD) - 2.7/3.0 TDI

### Features

- 1 kg Slide Hammer M10 x 1.0 - 300mm Overall Length
- 2 Leg Overhead Puller Assembly
- Offset J Adaptor
- C Hook Adaptor
- 22mm Hexagon Adaptor
- 17mm Hexagon Adaptor
- Tough Impact Resistant Carry Case



**Franklin Injector Pump Socket  
MB M33 1/2" dr  
TA909**

Suitable For Mercedes Benz Diesel 601 602 603 605 606 615 616 617

**Features**

- 33 Teeth x 55mm
- For Removing And Mounting The Pressure Valve Holder
- Matt Finish



1/2"



**Franklin 8 pce Cylinder Head Bolt Set 1/2" dr  
TA908**

Specialised Tool Set For Use On Popular Cylinder Head Bolts

- E12 Star x 140mm, T60 Star x 140mm, 10mm Hex x 140mm
- 12 pt Spline : M10 x 140mm - M14 x 100mm
- Ribe : M10 x 140mm - M12 x 120mm - M12 x 60mm

**Features**

- Chrome Vanadium Steel
- S2 Steel Bits
- Roll Marked Size For Easy Identification
- Size Organised Storage Aids Tool Selection
- Tough Steel Case With Clasp Lock



1/2"



**Franklin 4 pce Diesel Injector Socket Set  
TA904**

- 22 (7/8") 27 28mm - 12 Point 1/2" dr
- Extra Deep 22mm - 6 Point 1/2" dr

**Features**

- A set of special purpose sockets with access windows to allow for the injector wiring on many modern vehicles
- Chrome Vanadium Steel
- Size Marked For Easy Identification
- Tough Impact Resistant Carry Case



1/2"



Part No.	Description
TA726	22mm 12pt Additional Size No Window
TA727	27mm 12pt Additional Size No Window
TA731	27mm 12pt Window
TA734	22mm 12pt Window
TA921	21mm 12pt Additional Size With Window

**Franklin M16 100mm Tamperproof Spline 1/2" dr  
4416**

For Use On Cylinder Head Bolts

**Features**

- Chrome Vanadium Steel
- Satin Finish



1/2"



**Franklin 12 pt 19mm Deep Impact Socket 3/4" dr  
XB819**

19mm Bi-Hex Socket For MAN / Mercedes Cylinder Head Bolts

**Features**

- Chrome Molybdenum Steel
- Laser Etched Size Marking
- Black Finish



3/4"



**Franklin 2 pce V-Ribbed Belt Replacement Tool  
AT172**

A Special tool for removing and installing new elastic flexible self tensioning V-ribbed belts.

Belt Drives with this Type of Belt do not have a Belt Tensioner.

- Ford / PSA engines
- Citroen C4
- Peugeot 307
- Fiat Doblo/Stilo 1.6
- Ford Fiesta V/Fusion 1.25 1.4 1.6
- Focus C-Max 1.8
- Transit 2.0 DI
- Mazda II 1.25 1.4 1.6, III 1.4/2.0 - V 1.8/2.0 etc

**Features**

- Stretches The New Belt For Installation
- Fits New Belt onto Pulley with the Required Initial Tension

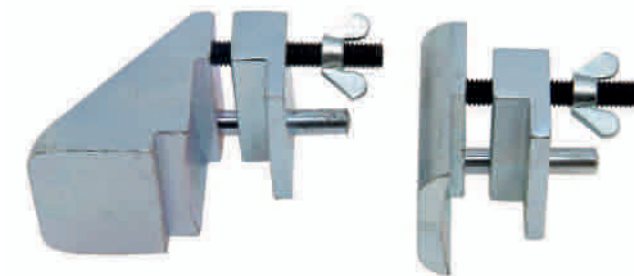

**Franklin 18pce Alternator Pulley Tool Set**  
**AT1770**

Interchangeable set of tools for replacing free wheel pulleys on Bosch and Magneti Marelli type alternators  
As used on - AUDI/BMW/FIAT/FORD/MERCEDES/SEAT/VW etc.

**Features**

- 3 x Combined Spline Adaptor/Bit Sockets
- 12mm Hexagon x 33 teeth Adaptor
- M10 Spline x 83mm - 3/8" dr
- 17mm Hexagon x 33 teeth Adaptor
- T50 Star x 113mm 1/2" dr
- M10 Spline x 113mm 1/2" dr
- 6 x Pulley Connector Adaptors
- 15mm Hexagon x 33 Teeth
- 22mm Hexagon x 33 Teeth
- 22mm Hexagon
- 28mm Hexagon x 19mm Hexagon
- 28mm Hexagon x 22mm Hexagon
- 17mm Hexagon x 4 (4mm) Pins
- 1 x M10 Spline bit Socket x 110mm - 1/2" dr
- 12mm Hexagon x 33 Teeth Adaptor
- 1 x M10 Spline Bit x 64mm - 12mm Hexagon
- 6 x 10mm Hexagon Shank Bits
- T40/T50 Star x 75mm
- M8/M10 Hexagon x 75mm
- 8mm/10mm Hexagon x 75mm
- 1 x 10mm Hexagon Bit Adaptor Socket 1/2" dr

**WARNING** - To avoid damage to the tool bits

**N.B. LEFT HAND THREAD TURN CLOCKWISE TO RELEASE AND TURN ANTI-CLOCKWISE TO TIGHTEN**



**Franklin Oil Filter Tool - Chain**  
**TA39**

**Features**

- Maximum Capacity 105mm Diameter
- For use with 1/2" Square Drive Ratchet, Extension Bar or 14mm Spark Plug Socket
- Use 21mm or 13/16" AF Spanner on Hex body



1/2"



**Franklin Heavy Duty Strap Oil Filter Wrench 300mm**  
**TA372**

For Use With Suitable Ratchet or Extension Bar, 14mm Spark Plug Socket or a 21mm (13/16AF) Spanner/Socket

**Features**

- Extra wide strap - up to 300mm diameter
- 3/8" and 1/2" Sq Dr



3/8" 1/2"



**Franklin Engine Pulley Puller Set**  
**TA406**

A professional quality set for removing crankshaft drive belt pulleys and other auxiliary pulleys

**Features**

- Adjustable jaw capacity 110 -195 mm and 40 -105 mm diameter
- Drop forged legs 68 & 90 mm with 70 mm screw adjustment
- Tough Impact Resistant Case



**Franklin Oil Filter Tool - Strap 1/2" dr**  
**TA41**

**Features**

- Maximum Capacity 105mm Diameter
- For use with 1/2" Square Drive Ratchet, Extension Bar or 14mm Spark Plug Socket
- Use 21mm or 13/16" AF Spanner on Hex body



1/2"



**Franklin Heavy Duty Strap Oil Filter Wrench**  
**AT3729**

Heavy Duty Strap for High Torque Requirements

**Features**

- 3/8" and 1/2" Drive Squares
- Range up to 9" (288mm)



3/8" 1/2"





**Franklin Swivel Head Oil Filter Wrench 3/8" dr  
TA38**

This Oil Wrench is Ideal for use when Access is Restricted

**Features**

- 75 - 120mm dia - 3/8" dr with 1/2" dr Female x 3/8" Male Adaptor
- Two Way Swivel Head Action



3/8"



**Franklin Reversible Filter Wrench  
66-94mm 3/8" dr  
TA384**

Suitable for use on Most Filters - From 66 to 94mm dia.

**Features**

- Shaped Steel Jaws Grip the Filter Flutes Without Slipping.
- Reversible Spring Tension Design
- Can be used with most 3/8" dr Accessories or a 17mm Hexagon Socket/Wrench



3/8"



**Franklin Oil Filter Plier - Swivel Jaw  
TA377**

Designed For Releasing Stubborn Filters Where Access Is Restricted

**Features**

- 57 - 120 mm diameter - 325 mm
- Jaws Swivel 90 Degrees in Either Direction in 30 Degree Increments to Access a Wide Range of Popular Oil and Fuel Filters
- Heavy Duty Drop Forged Serrated Jaws
- Extra Long Handles
- Dipped Handles For Comfort Whilst in use



**Franklin Filter Cups 3/8" dr**

3/8" dr Cap Style Wrench For the Removal of Oil Filters

**Features**

- Pressed Steel
- Black Finish

Part No.	Description
TA364	65mm x 14 Flute Toyota-GM
TA391	76mm x 14 Flute Mercedes
TA392	88mm x 16 Flute BMW-Volvo
TA393	93mm x 15 Flute Transit
TA394	76mm x 12 Flute Ford-Renault
TA395	92mm x 10 Flute Fiat-Lancia



3/8"



**Franklin Swivel Head Oil Filter Wrench 3/8" dr  
TA381**

This Oil Wrench is Ideal for use when Access is Restricted

**Features**

- 63 - 102mm - 3/8" dr with 1/2" dr Female x 3/8" Male Adaptor
- Two Way Swivel Head Action



3/8"



**Franklin Oil Filter Pliers**

Designed For Releasing Stubborn Filters Where Access Is Restricted

**Features**

- Heavy Duty Drop Forged Serrated Jaws
- Extra Long Handles
- Dipped Handles For Comfort Whilst in use
- TA376 - For use on Heavy Commercials, Tractors etc.

Part No.	Description
TA374	45 - 89 mm diameter - 250 mm
TA375	54 - 108 mm diameter - 300 mm
TA376	95 - 178 mm diameter - 500 mm



**Franklin Oil Filter Tool - 180 Degree Swivel**

Used To Access Filters in Confined Areas

**Features**

- Dipped Handles for Comfort Whilst in Use

Part No.	Description
TA360	50 - 65mm dia
TA361	65 - 83mm dia
TA362	75 - 95mm dia
TA363	100 - 115mm dia



**Franklin 36mm Surface Drive Bi-Hexagon Socket 1/2" dr  
TA918**

BMW, Mercedes, and GM Oil Filters

**Features**

- Chrome Vanadium Steel
- Roll Marked Size For Easy Identification



1/2"



## Franklin 13 pce Euro Cup Filter Set 3/8" dr TA380

Set of 11 Cup Filter Wrenches for Popular European Vehicles

- 66mm x 6 Flute
- 76mm x 8 Flute
- 76mm x 12 Flute
- 86mm x 16 Flute
- 86mm x 18 Flute
- 92mm x 10 Flute
- 93mm x 45 Flute
- 96mm x 18 Flute
- 106mm x 15 Flute
- 108mm x 15 Flute
- 108mm x 18 Flute

### Features

- Fiat, Ford, Lancia, Renault, Volvo, VW
- 1/2" F x 3/8" M Adaptor - Included
- Includes 3 leg adjustable filter wrench 65 - 120mm
- Tough Impact Resistant Carry Case



3/8"

FRANKLIN  
Professional Quality Tools

## Franklin 15 pce Cup Filter Set 3/8" dr TA390

- 65mm x 14 Flute
- 65 / 67mm x 14 Flute
- 68mm x 14 Flute
- 73mm x 14 Flute
- 74 / 76mm x 15 Flute
- 76mm x 14 Flute
- 76mm x 30 Flute
- 75 / 77mm x 15 Flute
- 80mm x 15 Flute
- 80 / 82mm x 15 Flute
- 90mm x 15 Flute
- 93mm x 15 Flute
- 93mm x 36 Flute
- 100mm x 15 Flute
- 1/2" F-3/8" M Adaptor

### Features

- Tough Impact Resistant Carry Case



3/8"

FRANKLIN  
Professional Quality Tools

## Franklin Oil Sump Repair Kits

For sumps where the thread has stripped.

Set of six replacement sump plugs with washers.

### Features

- Supplied with alloy steel tap
- No Drilling is required
- Remove the damaged sump plug
- The tap should be one size larger e.g. for original thread M14 x 1.5 a M15 x 1.5 tap is required
- Use a tap holder to re-thread the hole. Insert the new sump plug and washer



FRANKLIN  
Professional Quality Tools

Part No.	Description
AT3132	M13x1.25 (for M12x1.25)
AT3135	M13x1.50 (for M12x1.50)
AT3155	M15x1.50 (for M14x1.50)
AT3175	M17x1.50 (for M16x1.50)
AT3205	M20x1.50 (for M19x1.50)
AT3225	M22x1.50 (for M21x1.50)

## Franklin 5 pce Male Drain Plug Key Set 318

To Cover A Wide Range Of Car And Light Commercial Applications

### Features

- 10 sizes Double ended
- Hexagons : 5/16" (8 mm) x 9 mm, 10 x 12 mm, 14 x 17 mm
- Squares : 8 mm x 13 mm, 3/8" (10 mm) x 11 mm
- Roll Marked Size For Easy Identification
- Tough Impact Resistant Carry Case



FRANKLIN  
Professional Quality Tools

Part No.	Description
3181	14 x 17 mm Hex
3182	10 x 12 mm Hex
3183	5/16 x 9 mm Hex
3184	8 x 13 mm Square
3185	3/8 x 11 mm Square

## Mityvac Manual Vacuum/Pressure Fluid Evacuator AM7201

Designed for extracting and dispensing all types of lubricating, transmission, engine oils and coolants.

### Features

- Evacuates or dispenses at the push of a button
- Convenient manual pump operation
- Integrated 2.3 gallon (8.8 litre) capacity reservoir
- Large base with foot stabilizer
- Durable chemical resistant polyethylene construction
- Automatic overflow prevention
- Quick-drain pour spout
- No power or air needed
- Small and Portable

### Includes

- Fluid evacuator/dispenser
- 0.23" OD x 5' long (5.7mm OD x 1.5 m long) dipstick tube
- 0.26" OD x 5' long (6.6mm OD x 1.5 m long) dipstick tube
- 0.41" OD x 5' long (10mm OD x 1.5 m long) main evacuation tube
- Tube adapters
- User manual

### AM7205 - Brake Bleed Adaptor

The AM7205 quickly connects to the AM7201 fluid evacuator, converting it into a one-person vacuum brake or hydraulic clutch bleeder. The kit contains a vacuum bleed tube with brass ball valve, universal bleed screw adaptor, and adapter for connecting to the evacuator.

Part No.	Description
AM7205	Brake Bleeding Adaptor



**mityvac**

## Franklin Oil Filter Drain Tube - VAG 2.0 FSi/TFSi TA389

Designed to Allow the Oil Filter to be Drained Prior to Removal to Avoid Oil Spillage in Accordance with the VAG Workshop Manual Procedure.

AUDI - SEAT - SKODA - VOLKSWAGEN

### Features

- 50cm Hose for Draining Oil Filter Housing on VAG FSi Petrol Engines
- Minimises Oil Spillage
- Use with Suitable Oil Drain Pan



**FRANKLIN**  
Professional Quality Tools

## Franklin Oil Dipstick - Audi / VAG AT3111

- For use on Audi A4/A5 models with electronic oil level system
- Use as OEM T40178
- DO NOT EXCEED THE MAXIMUM OIL LEVEL  
(Please see the Maximum Oil Level Chart on the web Download Tab)



**FRANKLIN**  
Professional Quality Tools

## Franklin 2-in-1 Waste Oil Drainer NPE090

Designed to drain waste oil by either gravity or suction from engines, gear boxes and differentials of all vehicles. The emptying of the drained oil inside the reservoir is air operated. Adaptors for BMW and Volkswagen are also included

### Features

- Tank capacity 90 litres (Draining capacity 80 litres)
- Air pressure for vacuum 100-114 psi
- Suction speed 1.5-2.0 litre/min (with oil at 70-80 Degrees)
- 2 metre Draining hose
- 2 metre Suction hose
- Overall size 630 x 415 x 1700 mm
- G.W. 41 kg (empty)
- Includes six suction probes (metal and flexible)
- Equipped with quick couplers for fluid extraction
- Adjustable collection bowl height Self-evacuating feature makes emptying clean and simple



**FRANKLIN**  
Professional Quality Tools

## Franklin Drain Pans

C117 - High density black polyethylene drain pan with a 16ltr capacity

C118 - High density silver polyethylene drain pan with a 17ltr capacity

C119 - High density green polyethylene anti-freeze drain pan with a 16ltr capacity

### Features

- Chemical / solvent resistant
- Built-in anti splash lip and baffles
- Large spout for fast pouring
- Supplied with threaded spout cap for safe transportation

Part No.	Description
C117	Drain Pan BLACK
C118	Drain Pan SILVER
C119	Drain Pan GREEN



**FRANKLIN**  
Professional Quality Tools

## Franklin Vehicle Fluid Change Syringe Transmission Fluid

### A46008

To Add/Remove - Transmission Fluid/Engine Oil/Gear Oil

### Features

- Rotating Off Switch
- Transparent Design Allows Fluid Level Check
- Suitable for Fluid Suction and Supply in Vehicle Service
- Composite Plastic
- 1.5L Capacity

Part No.	Description
A4608S	Franklin Set of 2 Seals for A46008



**FRANKLIN**  
Professional Quality Tools



## Franklin Vehicle Fluid Change Syringe Brake Fluid + Antifreeze

**A46009**

To Add/Remove - Brake Fluids and Antifreeze

**Features**

- Quick Disconnect
- Transparent Design Allows Fluid Level Check
- Suitable for Fluid Suction and Supply in Vehicle Service
- Composite Plastic
- 200cc Capacity

Part No.	Description
A4609S	Franklin Set of 2 Seals for A46009



## Franklin Fuel Syringe

**A46011**

Helps To Remove Air Locks When Replacing Fuel Filters

**Features**

- Transparent Design Allows Fluid Level Check
- Suitable to Add or Remove Petrol or Diesel Fuel from Filters
- Rotating Off Switch
- 1.5L Capacity

Part No.	Description
A4611S	Franklin Set of 2 Seals for A46011



## Franklin Plastic Measure Jugs

- Made from Heavy Duty Polyethylene
- Suitable for all types of fluids including Petrol and Diesel
- Flexible Spout to Reach Difficult Areas
- Screw Caps for Jug and Spout to Prevent Contamination
- Metric and Imperial Measurements
- Translucent Container for easy Visual Measurement

Part No.	Description
C111	1 litre
C112	2 litre
C115	5 litre



## Franklin Oil Suction Gun 500cc

**C127**

For the Extraction of Oil

**Features**

- 300mm Flexible Hose
- Metal Body



## Franklin AD Blue Syringe

**A46012**

To Add/Remove AD Blue Liquid from Reservoir Tanks

**Features**

- Transparent Design Allows Fluid Level Check
- Rotating Off Switch
- 1.5L Capacity



## Franklin 500cc Fluid Transfer Pump

**C126**

For the Transfer of Non-Flammable Fluids

**Features**

- Double Action
- Pull stroke draws the fluid into the pump
- Push stroke expels the fluid from the pump
- No priming is required
- All metal body 58mm diameter x 330mm
- Supplied with 2.4 metres x 1/2" id hose
- Not suitable for flammable liquids



## Franklin Oil Cans

For General Lubrication Uses

C125 - Mini Oil Can 125cc

**Features**

- 100mm Fixed Spout
- Durable Metal Construction
- Painted Body

C355 - Oil Can 500cc

**Features**

- 155mm Flexible Spout
- Durable Metal Construction
- Painted Body

Part No.	Description
C125	125cc
C355	500cc



## Franklin Grease Gun 500cc Side Lever

**C500**

Heavy Duty Variable Stroke Lever Action Grease Gun

**Features**

- 7000 psi / 480 bar Maximum Working Pressure
- Positive grip handle
- Non-slip knurled barrel
- 3 Way Loading - Bulk/Filler Nipple/Cartridge
- Complete with Rigid Stem and 4 Jaw Connector
- Metal Body
- Ergonomic Handle for comfort in use



Part No.	Description
C1	4 Jaw Connector
C7	300mm Nylon Hose
C9	450mm Nylon Hose



## Franklin Plastic Funnels

Can be used for a variety of Garage and Workshop Fluids

### C150

- 150mm
- Made from High Grade Polyethylene - 6" diameter
- Comes with Plastic Filter
- Hanging Hook

### C200

- 200mm
- Made from High Grade Polyethylene - 8" diameter
- Hanging Hook

### C250

- A versatile funnel for garage or agricultural workshop use
- 255 x 165mm opening accepts upended oil containers
- Tapered spout with venting ribs and filter
- Polyethylene - resistant to oil and fuel
- Comes with a Metal Gauze Filter

Part No.	Description
C150	Plastic Funnel 150mm
C200	Plastic Funnel 200mm
C250	Tractor / Workshop Funnel



## Franklin Cooling System Filler Kit 165mm dia AF903

Built-in Shut Off Valve and Special Flow Pipe Design to help to Prevent Air Locks

### Features

- 165mm diameter - 1.3 litre funnel
- Supplied with 6 Reservoir Filler Adaptors to suit a Range of the Most Popular Sizes
- 31, 35, 40, 42, 45mm
- Universal 20-30mm (Tapered)



## Franklin 5 pce 500mm Nut Driver Set 1/4" dr 9894

500mm Long Driver

### Features

- For 6 point Hexagon Nuts
- Soft Grip Handle
- Flexible Rubber Blade
- Supplied with 6 7 8 and 10mm Sockets 1/4" dr



## Franklin Fuel Filter Socket - HDi TDCi 27mm 1/2" dr TA3827

Specialist Socket for the Removal and Refitting of Fuel Filters

- Ford, Citroen, Peugeot, Models with 2.0 (DW10C) and 2.2 (DW12C) HDi / TDCi Diesel Engines

- C-Max / Focus / Galaxy / Kuga / Mondeo
- S-Max Citroen - C4 / Picasso / Grand Picasso
- C5 Peugeot - 308 / 3008 / 508 / 5008 / 407

### Features

- Chrome Vanadium Steel
- Laser etched size markings (for easy identification)
- Satin Finish



1/2"



## Franklin Fuel Filter Tool GM Diesel CDTi 1/2" dr TA355

For GM Opel and Vauxhall Models with CDTi Diesel Engines Also suitable for use on Alfa / Fiat 1.9 JTD and Saab 1.9D Models Equivalent to OEM Tool KM EN-46784-020/010

### Features

- 2 Pce Set for Removing The Fuel Filter From The Housing
- The Plastic Holder is used to Hold The Assembly
- The Key is used to Grip and Release the Filter
- Can also be used to Tighten to the Specified Torque Setting Using the 1/2" dr



1/2"



## Franklin 3 pce Nut Driver Set 6 7 & 8mm 9893

6 7 8mm x 250mm Long

### Features

- For 6 point Hexagon Nuts
- Soft grip handles
- Flexible rubber blades
- Roll Marked Size For Easy Identification

Part No.	Description
98936	6mm
98937	7mm
98938	8mm



## NutDriver Pro Flexi Lock Nut Driver ANDP7

NutDriverPro Ensures Faster and Easier Work in Confined Spaces

### Features

- 7mm Hexagon
- 330mm Long
- Flexible Shaft
- For Hose Clamps and Nuts etc.
- Locks Onto Hex Nuts



**Franklin Long Reach Hose Clamp Pliers TA579**

Suitable for most Popular Makes of Car and Light Commercial Vehicles

**Features**

- For use on re-useable spring band type hose clamps
- Capacity 18-54mm diameter
- Used on Fuel, Oil and Water Hoses
- Ratchet Action With Quick Release
- Long Reach 600mm Flexible Arm

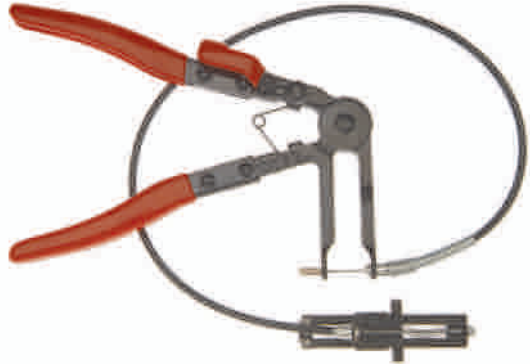

Part No.	Description
15791	Replacement Cable+Jaw



**Franklin Hose Clip Plier - Wire Type TA774**

Removes and Installs Hose Clips

**Features**

- Swivel Tips To Grip at any Angle
- Locking Handle Allows User to Maintain Open Position and Hold Clamp in Place



**Franklin Hose Clamp Plier Clic TA776**

Swivel Jaw For CLIC and CLIC-R type

**Features**

- 45 Degree Angled Jaw Provides Improved Access to Clamps
- Swivel Tips Designed for Re-fitting and Release of Clamps
- Dipped PVC Handles for Improved Comfort and Grip
- For Most Popular Cars And Light Commercial Vehicles



**Franklin Soft Hose / Pipe Cutter TA779**

Strong Red Plastic Hose/Pipe Cutter

**Features**

- Stainless steel blade
- Capacity 32mm
- Strong Moulded Plastic



**Franklin Spring Hose Clip Tool 1/4" dr AT578**

Designed to help remove hoses fitted with constant pressure type hose clips widely found on modern vehicles

**Features**

- 60mm Screw Adjustment
- Use by hand or with 14mm socket / 1/4" sq dr
- 105mm Overall Length
- Fast and Effective



**1/4"**



**Franklin Hose Clip Plier - Band Type TA775**

Removes and Installs Hose Clips

**Features**

- Swivel Tips To Grip at any Angle
- Locking Handle Allows User to Maintain Open Position and Hold Clamp in place



**Franklin Hose Clip Pliers Clic TA778**

For Releasing and Re-Fitting CLIC and CLIC-R Type Re-Usable Hose Clips

**Features**

- Suitable for Most Popular Cars and Light Commercial Vehicles
- 170mm Long
- Dipped PVC Handles for Improved Comfort and Grip



**Franklin Exhaust Clamp Tool - VAG AF582**

For Replacing Exhaust / Manifold Spring Clamps on Early VAG Models with 4 Cylinder Water Cooled Engines  
AUDI - SEAT - SKODA - VOLKSWAGEN

**Features**

- 17mm Hexagon Drive





## Franklin 5 pce Oxygen Sensor Set TA903

Suitable For Oxygen Sensors found on most modern vehicles  
Slots enable socket and wrenches to be fitted over wiring harness

### Features

- M12 x 1.25mm - M18 x 1.50mm Thread Chasers For cleaning lambda sensor threads
- 22mm Offset Wrench x 30mm 3/8"dr
- 22mm Offset Wrench x 50mm 1/2"dr
- 22mm Socket (with slot) x 78mm 3/8"dr
- Tough Impact Resistant Carry Case



3/8" 1/2"

FRANKLIN  
Professional Quality Tools

## Franklin 22mm Oxygen Sensor Socket 3/8" dr TA902

For Quick Removal or Replacement of Oxygen Sensors

### Features

- Extra Deep
- Access Slot
- Chrome Vanadium



3/8"

FRANKLIN  
Professional Quality Tools

## Franklin 7 pce Lambda Sensor Socket Set TA907

5 Special Purpose Sockets and 2 Wrenches  
With Access Windows Allowing For the Wiring on Zirconia/Titania Oxygen Lambda Sensors on Many Modern Vehicles

### Contents

- 22mm (7/8") x 30mm Wrench 3/8" dr
- 22mm (7/8") x 50mm Wrench 3/8" dr
- 22mm (7/8") x 80mm Socket 3/8" dr
- 22mm (7/8") x 90mm Socket 1/2" dr
- 1" and 11/16" x 74mm Socket 3/8" dr
- 27mm x 85mm 12 pt Socket 1/2" dr
- 29mm x 90mm Socket 1/2" dr

### Features

- Chrome Vanadium and Chrome Molybdenum Steel
- Tough Impact Resistant Carry Case

3/8" 1/2"



FRANKLIN  
Professional Quality Tools

Part No.	Description
TA901	Oxygen Sensor Wrench 22mm Hex 3/8"dr - Also Available
TA902	Oxygen Sensor Socket 22mm 3/8"dr
TA731	27mm Window

# Drivetrain - P

## Contents

Bearing & Hub	P2
Suspension	P5
Brake Tools	P6
Wheel & Tyre	P14

**FF Franklin & Co Ltd**

Platt Street

Sheffield

S3 8BQ

England

**Telephone**

0114 272 1429

**Facsimile**

0114 272 7030

**Email**

orders@franklin-tools.co.uk

# 2020

[www.franklin-tools.co.uk](http://www.franklin-tools.co.uk)



## Franklin 25 pce Hydraulic Puller Set TA985

A comprehensive master set of two/three leg pullers with a forged steel bearing separator

### Features

- 10T Hydraulic ram (1.5" fine pitch thread) Nosepiece with 2" and 4" extension pieces
- Two and three position heads and a 1.5" boss
- 4" 6" and 8" sets of three forged alloy steel legs
- Bearing Separator with beam and main rods with extension rods. 75-105mm
- Tough Impact Resistant Carry Case



Part No.	Description
19801	10T Hydraulic Ram
19802	2" Ram Extension
19804	4" Ram Extension
19805	Ram Nose Piece
19809	Seal Kit for 19801
19851	Centre Nut
19852	Twin Yoke Head
19853	Triple Yoke Head
19854	4" Puller Leg
19856	6" Puller Leg
19857	Nut and Bolt For Legs
19858	8" Puller Leg
19891	75-105mm Bearing Separator
19892	Separator Beam
19893	Main Rod Assembly
19894	Extension Rod



## Franklin Internal Blind Bearing Puller Set AT9710

For the Removal of Pilot Bushes, Bearings etc.

### Features

- 5 - Adjustable Collets : 8-11 12-17 18-23 24-29 30-34mm
- 3 - Threaded Adaptors : M6 x 1.0 - M8 x 1.25 - M10 x 1.50
- 1 x 0.9kg Slide Hammer - 295mm Long
- 1 x 2 Leg Puller - 140mm Long
- Tough Impact Resistant Carry Case



## Franklin Bearing Packer TA155

- For Use With a Grease Gun
- Forces Out Old Grease and Evenly Injects New Grease Into The Bearing



## Franklin 12pce Bearing Separator Set TA974

Suitable for Automotive and General Use

### Features

- 2pce Puller - Capacity 30-55mm x 170mm
- 2pce Puller - Capacity 70-90mm x 220mm
- 2 x Main Rod - Hex Bar 17mm x 127mm Length
- 2 x Extension Rod - Hex Bar 17mm x 127mm Length
- 2 x Main Rod - Hex Bar 14mm x 102mm Length
- 2 x Extension Rod - Hex Bar 14mm x 102mm Length
- 1 x Beam
- 1 x Centre Bolt 175mm Length
- Sturdy storage case

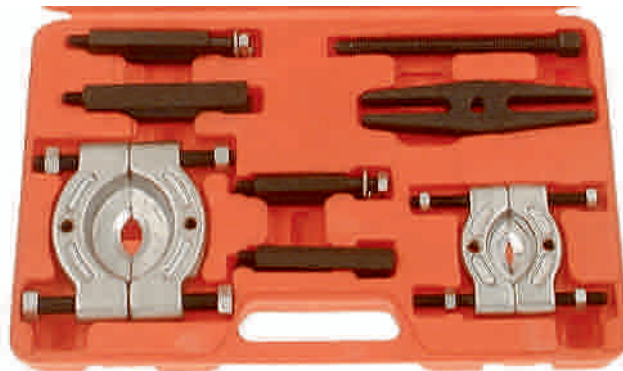

## Franklin 2/3 Leg Puller

For Pulling Gears, Axles, Bearings etc

### Features

- 3 x Reach Sizes - 3" (TA971) 4" (TA972) 6" (TA973)
- Suitable for Either Internal or External Use
- Jaw Length is Adjustable
- Chrome Vanadium Steel YOKE and JAWs for Strength and Durability
- Fine Thread Centre Bolt For Maximum Torque Pull with Minimal Effort
- For Configuration as 2/3 Leg Puller
- Heavy Duty

Part No.	Description
TA971	2T 2/3 Leg Puller 80mm/120mm
TA972	5T 2/3 Leg Puller 84mm/175mm
TA973	5T 2/3 Leg Puller 140mm/175mm



## Franklin 16 pce Bushing Driver Set 10-32mm TA156

Suitable for Replacing Smaller Bushes, Bearings and Seals etc. As Used On Various Vehicles, Electric Motors and Other Components and Equipment

### Features

- 3 Driver Handles
- Small - 11mm / Medium 16mm / Large 21mm
- 13 Stepped Adaptors
- 10/12, 12/14, 14/16, 15/17, 16/18, 18/20, 19/21, 20/22, 22/24, 25/27, 26/28, 28/30, 30/32mm
- Tough Impact Resistant Carry Case

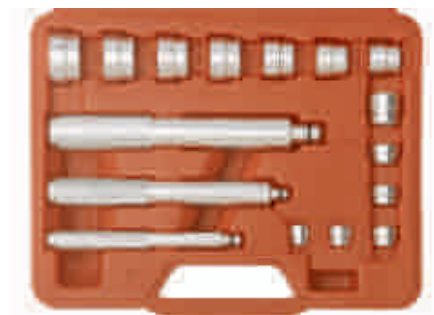



**Franklin Clutch Alignment Tool**  
**F028**

For use on Cars and Light Commercial Vehicles (including FWD with Spigot bearing in the flywheel)  
Designed to Allow Single Plate Clutches to be Assembled and Aligned off the Vehicle ready for Easy Installation

- Features**
- 4 pce Multi-Fit Clutch Mandrel
  - Complete with three expanding collets (15-18mm, 18-23mm, 23-30mm)
  - **NOTE :Not Suitable for use on BL A Series Minis or Double Plate Clutches**



**Franklin CV Boot Clip Cutters**  
**TA575**

For Use on Stainless Steel Retaining Bands Used on Car CV Boots

- Features**
- Designed to Reduce the Risk of Damage to the CV Boot Rubber
  - Also Suitable For Cutting Hose Clamps Up To 10mm Wide x 0.50-0.70mm Thick

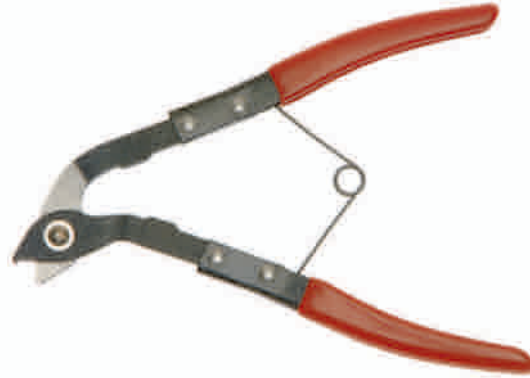

**Franklin Fork Ball Joint Separator**  
**TA338**

For Splitting Ball Joints on Cars and Light Commercial Vehicles

- Features**
- 16" x 18mm Jaw - 400mm Long
  - Drop Forged Steel



**Franklin Ball Joint Separator 22mm Jaw**  
**TA330**

For Splitting Car/Light Commercial Track Rod Ends, Anti-Roll Bar Mountings and Ball Joints

- Features**
- Duel Pivot Points Provide Maximum Openings of 30 and 58mm
  - 22mm Open Ended Jaw with 36mm Depth
  - Drop Forged and Heat Treated Body



**Franklin CV Boot Clip Crimping Pliers**  
**TA574**

For Use on Metal Ear Type Clips as Used on Front Wheel Drive CV Joint Boots

- Features**
- Ergonomically Designed Dipped Handles for Extra Grip



**Franklin HD CV Boot Clamp Pliers**  
**AF576**

For Use on Stainless Steel Clamp Bands on Drive Shafts

- Features**
- Heavy Duty Pliers for use on Stainless Steel CV Boot Clamps
  - Used by Hand or with a Torque Wrench - When a Specific Torque Setting is Required
  - Ergonomic Handle for comfort and grip



**Franklin Ball Joint Separators**

For Splitting Car and Light Commercial Track Rod Ends, Anti-Roll Bar Mountings and Small Ball Joints

- Features**
- Drop Forged Chrome Vanadium Steel Hardened and Tempered
  - TA334 - 18 mm Jaw and Overall Capacity Up To 40mm Wide With Up To 35mm Screw Adjustment
  - TA335 - 23 mm Jaw and Overall Capacity Up To 50mm Wide With Up To 45mm Screw Adjustment

Part No.	Description
TA334	18mm Jaw
TA335	23mm Jaw



**Franklin Ball Joint Separator - Commercial**  
**AC040**

For HGV's and Commercial Vehicles

- Features**
- Scissor Action Allows Use Where Access Is Limited
  - 36mm Hexagon Drive Bolt
  - 70mm Jaw Opening
  - 36mm Jaw Width
  - 44mm Jaw Depth
  - Heat Treated Drop Forged Steel Body



## Franklin 11 pce Slide Hammer / Puller Set TA977

Slide Hammer Set for Automotive and General Use

### Features

- 2.2kg x 570mm Slide Hammer
- Range of Hub Dent and Lip Pullers Provided
- Internal 2 leg 35-110mm x 82mm, 3 leg 50-135mm x 82mm Reach
- External 2 leg 50-140mm x 75mm Reach, 3 leg 20-135mm x 75mm Reach
- Tough Impact Resistant Carry Case

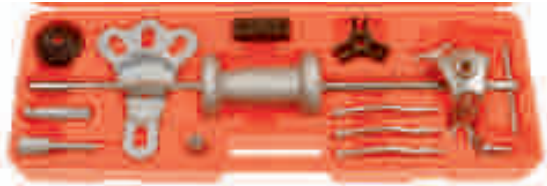

## Franklin Slide Hammer 600mm 4lbs 008C

Suitable for use with TA979 Hub Puller

### Features

- 600mm Long
- 2.2kg - 4lbs Weight
- 5/8" UNF Thread



## Franklin 5T Universal Hub Puller 5/8" UNF TA979

For 4 / 5 Stud Hubs 95 - 128mm p c d

### Features

- High Tensile Forcing Screw
- Also Suitable for use with 5/8" UNF Slide Hammer - e.g. 008C when a Reverse Impact is Required for Removing Certain Hubs or Flanged Shafts



## Franklin Coil Spring Compressor TA30

For Use on MacPherson Strut and Standard Coil Springs

### Features

- Set Of Two, With Drop Forged Arms
- 1/2" sq dr / 13/16" A/F Drive Nut 90 x 200mm



1/2"



## Franklin 5 pce Strut Nut Tool Set VAG TA3515

For the Removal and Installation of Strut Nuts

### Features

- VW/Audi - 10.5 12.5 14.0 14.5
- Mercedes - W203/W209 14.0 x 14.5
- Chrome Vanadium Steel
- Roll Marked Size For Easy Identification



## Franklin Pressure Brake Bleeder 4 litre AF402

One Man Brake and Clutch System Bleeder

In Most Cases a Full System Flush can be Performed with a Single Fill Without Emptying the Vehicles Main Reservoir

### Features

- 42mm Cap to Suit Most European Cars and Light Commercial Derivatives
- Capacity - 4 Litres
- Maximum 28psi

Part No.	Description
AF403	Multicap Adaptor for AF402



## Franklin Vacuum Brake Bleeder AF404

One Person Brake Bleeder for use on a wide range of popular Cars and Light Commercial Derivatives

Vacuum Draws Fluid From The Brake Nipple Using The Rubber Adaptor

### Features

- For Bleeding or Full Fluid Replacement
- Capacity - 0.75 litres
- 1/4" BSP Inlet
- Workshop Air Supply - 90 to 120psi required
- Air Consumption 185l/min (6.5cfm)

Part No.	Description
14041	Adaptor for bleed nipple (AF404)



## Franklin Brake Fluid Tester AF410

Tests Brake Fluid Moisture Level

### Features

- Easy to use
- GREEN - PASS
- AMBER - WARNING if the Moisture Level is Over 1.5%
- RED - FAIL
- Supplied with 1 x AAA Battery



**Franklin Vacuum Test Set / Brake Bleeder**  
**AF401**

- Automotive Vacuum Test Kit and Brake Bleeder - Range 0-30" Hg / 0-76 cm Hg
- For Testing Vacuum Systems and General Fault / Diagnostic / Troubleshooting
- Tests Engine Condition - Fuel / Ignition / Transmission / Brake and Clutch Systems / Carburettors / • Fuel Lines and Pumps / Valves and Switches etc

• Also Suitable for the Vacuum Bleeding of Brake and Clutch Systems

**Features**

- 3 x Brake Bleeder Fittings
- 12 assorted Vacuum Hose Fittings
- Reservoir Bottle
- PVC Hose - Vacuum 2 x 500mm
- PVC Hose - Vacuum 1 x 100mm
- PVC Hose - Container 1 x 70mm
- Guidance Instruction Manual
- Tough Impact Resistant Carry Case



**Franklin Brake Flaring Tool - Rotating Turret**  
**BF2001**

3/16" SAE and 4.75mm DIN Automotive Flares on Steel, Copper and Cupro Nickel Brake Pipes

**Features**

- Plastic Dipped Handle for Good Grip
- Tough Impact Resistant Carry Case
- To Be Used In a Vice

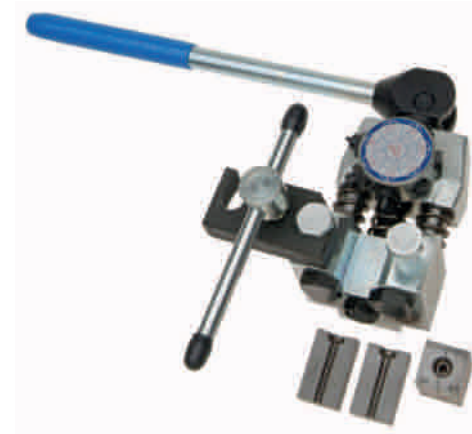

**Franklin Mini Tube Cutter 3-16mm dia.**  
**TA764**

Capacity 1/8" - 5/8" (3-16mm) O.D.

**Features**

- Tungsten Steel Cutter
- Twin Rollers
- For Copper Brake Pipes etc.



**Franklin Brake Flaring Tool - Hand Held**  
**AF2003**

3/16" SAE - Designed for use on the Vehicle to Produce Single and Double SAE Flares

**Features**

- Can be used on Steel, Copper and Cupro Nickel Brake Pipes
- Can be used with a Ratchet and Socket or Standard Spanner
- Supplied in plastic storage case



Part No.	Description
AF2004	4.75mm DIN Brake Flaring Tool (AF2004)
AF2006	6mm SAE Flaring Tool (AF2006)
AF2901	Depth Stop
AF2920	Pair Socket Cap Screws
AF2950	Spare 3/16" Punch (AF2003)
AF2954	Spare 4.75mm Punch (AF2004)
AF2960	Spare 6mm Punch (AF2006)



**Franklin Tube Cutter 3-28mm dia.**  
**TA760**

Capacity 1/8" - 1 1/8" (3-28mm) O.D.

**Features**

- Tungsten Steel Cutter
- Twin Rollers
- Fold Away De-Burring Blade



**Franklin Pipe Bending Plier**  
**TA763**

Two Roller Adaptors for Bending 3/16" 1/4" 5/16" 3/8" Copper and Steel Tube Without Kinking





**Irwin Pipe Bender 3-6mm 3/16"**  
**AT210**

1/8" - 3mm / 3/16" - 4mm / 1/4" - 6mm

**Features**

- Compact Tool for use in Confined Spaces
- Not Suitable for use on Steel Pipe



**Franklin Flare Nut Wrench 10x11mm**  
**TA751**

For use on Brake Pipe Unions and other general applications  
10 x 11mm

**Features**

- Chrome Vanadium Steel
- Jaws Allow for Maximum Contact with the Nut When Applying Torque
- Angled Heads Allow for Better Access



**Franklin 4 in 1 Brake Cylinder Hone**  
**TA130**

- Small Brake Cylinders - 18-64mm (Twin Leg / 1 1/8" Stones / Medium collar)
- Brake / Clutch Cylinders - 19-68mm (Small Triple Leg / 1 1/8" Stones / Medium collar)
- Disc Caliper Cylinders - 18-64mm (Large Triple Leg / 3/4" Stones / Large spring)
- Small Engine Cylinders - 32-89mm (Large Triple Leg / 2" Stones / Large Spring)

**Features**

- Adjustable Range and Pressure
- 18 - 89mm Bore Diameter
- Use With a Variable Speed Electric Drill or Air Tool
- Tough Impact Resistant Carry Case



Part No.	Description
TA136	11 Piece Replacement Stone Set

**Franklin Brake Pipe Aid Pliers**  
**TA762**

For 3/16" and 1/4" Diameter Brake and Fuel Lines

**Features**

- Use to Align, Bend and Adjust Brake and Fuel Lines
- Shaped Jaws Bend Tube without Distortion
- Forged Steel with Heavy Duty Grips for a Secure Hold During Use



**Franklin 6 pce Flare Nut Wrench Set 8-19mm**  
**FT576**

For use on Brake Pipe Unions and other general applications  
8 x 9 10 x 11 12 x 13 14 x 15 16 x 17 18 x 19mm

**Features**

- Chrome Vanadium Steel
- Satin Finish
- Supplied in a Roll For Storage Convenience
- Roll Marked Size For Easy Identification



**Franklin Brake Cylinder Hone**  
**TA135**

Supplied with 1 1/8" Medium Grade Stones

**Features**

- Capacity 25-63mm (1-2.5") Bore Diameter
- Flexible Shaft
- Spring Tension Adjustment
- For use with an Electric Drill or Airtool



**Franklin Brake Cylinder Clip Insert Tool**  
**TA138**

For drum brakes as used on Transit Metrocab, TX1 Taxi, Mini Metro etc

**Features**

- Enables The Retaining Circlips To Be Easily Installed Without Third Hand Assistance
- Supplied With Metric/Imperial Thread for Vehicles With Drum Brake Wheel Cylinders That are Retained by a Circlip



**Franklin Steel Brake / Fuel Hose Clamp  
TA765**

Plated Steel Clamp with Slide Action Locking Collar For Use on Flexible Brake / Fuel Lines

**Features**

- Smooth Round Edge Jaws To Prevent Damage to Hose Body



**Franklin Hose Clamp - Screw type  
TA770**

- For Use on Flexible Brake and Fuel Lines
- Plated Steel Clamp
- Rounded Section Helps Prevent Damage to the Hose Lining



**Franklin Brake Piston Spreader  
TA898**

For use on vehicles with Push Back Disc Piston Systems

**Features**

- Jaw Capacity 88mm
- Retracts Brake Piston to allow insertion of New Brake Pads
- Ensures parallel piston retraction, avoiding damage to piston seals
- For use on opposed fixed and single-piston sliding calipers
- Suitable for most ATE, Bendix, Delco and Girdling calipers



**Franklin 21 pce RH+LH Brake Service Set  
TA880**

A Comprehensive Tool Set with 18 Adaptors to Suit a Wide Range of Popular Car and Light Commercial Vehicles

**Features**

- For Servicing / Replacement of Worn Brake Disc Pads
- Right Hand and Left Hand Drive Units to Cover Vehicles with RH and LH Wind Back : Citroen C5, Ford Mondeo, Renault Master etc.
- Matt Finish
- Tough Impact Resistant Carry Case

Part No.	Description
18850	RH Windback Assembly
18860	LH Windback Assembly
1870P	Reaction Plate

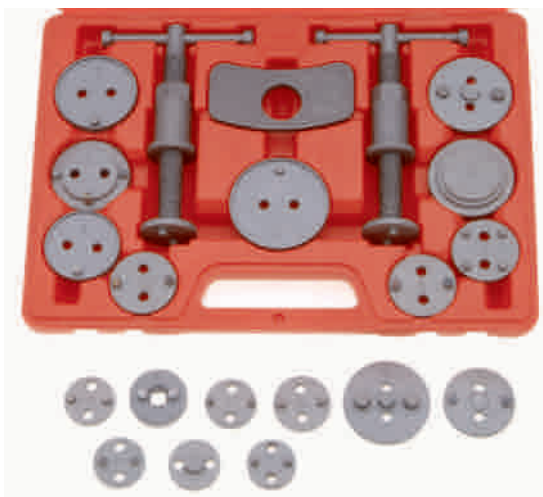

**Franklin Brake Piston Wind Back Tool  
TA871**

For Use When Replacing Brake Disc Pads

**Applications**

- Audi
- Fiat Uno Tipo
- Ford Sierra ABS (rear)
- Honda Prelude
- Jaguar XJ40
- Lancia Dedra Thema
- Nissan Silvia 1.8 Turbo
- Peugeot 306 307 405 407 605
- Renault Master
- Rover 800
- Saab 9000
- Seat Toledo
- Subaru L
- Volvo S40 V40

**Features**

- 42mm 2 Pin Adaptor With Right Hand Thread Driver
- Reaction Plate



**Franklin Brake Piston Wind Back Tool  
AT872**

For Disc Brake Calipers with Right Hand Thread on Most Popular European and Japanese Cars

**Features**

- 2 Pin Drive As Franklin TA871 TA880 TA886
- Reaction PLate
- Right Hand Thread
- 4mm o/d Pins
- Range 15-35mm PCD
- Adjustable 2 Pin Adaptor



**Franklin Left Hand Brake Wind Back Tool  
TA886**

For Quick and Efficient Winding of Brake Pistons With Left Handed Threads

**Features**

- For Use When Replacing Brake Disc Pads
- Left Hand Threaded Driver With Reaction Plate
- 2 Pin Adaptor



**Franklin Brake Wind Back Cube 3/8" dr  
TA899**

Rotates and Depresses Caliper Pistons Back Into The Caliper When Changing Brake Pads

**Features**

- Six Sided Adaptor 3/8" dr  
(NOT TO BE USED WITH CALIPERS WHERE PRESSURE IS REQUIRED TO REWIND)



**3/8"**



## Franklin Adjustable Adaptors

For Use With 2 Pin Driver as TA871 TA886 TA880 AT872

### Features

- 4.0mm o/d Pins
- AT8702 - Range 15-35mm pcd (2 pin)
- AT8703 - Range 21-35mm pcd (3 pin)

Part No.	Description
AT8702	2 Pin
AT8703	3 Pin



## PCL Tyre Tread Depth Gauge - 1-26mm 014T

VOSA / MoT Approved Tread Depth Gauge

### Features

- 1-26mm x 1mm Scale
- Pocket clip



## PCL Digital Tread Depth Gauge ATDG1

A straightforward and simple to use Digital Tyre Tread Depth Gauge measurement device with three different read settings. Suitable for tyre tread depth or brake shoe and pad wear

### Features

- Strong and robust housing material - made from extra strong carbon fibre composite
- Easy to read large LCD display
- Zero setting in any position - allows easy "calibration" for zero reset
- Metric, decimal inch and fraction inch (1/64 inch) toggle
- 1 battery - SR44 1.5v (supplied)
- Calibration 0-25 mm / 0-1 in
- Reading Resolution 0.01 mm / 0.0005 in / 1/64 in
- Accuracy 0.2 mm



## PCL Tyre Valve Repair Tool 520

4 in 1 Tool

### Features

- Cleans Inner and Outer Threads
- Removes / Extracts Valve Core



## Franklin 10 pce Suspension Spacer Set AFS10

Used to Pack Up Suspension - Following Coil Spring Failure - To **PUSH** Vehicle Onto Recovery Truck / Into Workshop. For **EMERGENCY USE ONLY - DO NOT DRIVE OR TOW Vehicles Whilst the Spacers are In-Situ**

### Features

- 5 x Large (30mm)
- 5 x Small (15mm)



## PCL 3 in 1 Digital Tyre Gauge ADTPG7

3-in-1 Digital Tyre Pressure and Tread Depth Gauge with light is ideal for working in the dark

### Tyre Pressure

- Accuracy +/- 1.5 %
- Reading Resolution 0.1 psi / 0.01 bar / 1 kPa / 0.01 kg/cm<sup>2</sup>
- Calibration 2-100 psi / 0.15-7 bar / 15-700 kPa

### Tyre Tread Depth

- Accuracy +/- 0.2 mm
- Reading Resolution 0.01 mm / 0.001 in
- Calibration 0-15 mm

### Features

- Measures pressure in psi / bar / kPa / kgf/cm<sup>2</sup>
- Measures tyre tread depth in mm / inch
- 90 Second Auto power off
- Self calibrating
- LED work light
- Hook and side hanger





**PCL Tyre Inflator 210 psi - 15 bar**  
**ADTG4**

PCL's Alloy Tyre Inflator is a general purpose tyre inflator. The ADTG4 Alloy Tyre Inflator has a durable alloy body, rubber protected gauge and comes complete with operating instructions

- Features**
- Reading Accuracy 2 psi / 0.1 bar / 10 kPa
  - Maximum Inlet Pressure 15 bar
  - Hose Length - 0.85m
  - Tyre Valve Connection - Euro Clip-on
  - Simple and easy to use
  - For General Low Volume Tyre Inflation



**PCL AIRFORCE MK4 Truck Tyre Inflator**  
**AFG5H**

A heavy duty solution for providing safe, cost-effective and trouble-free high pressure inflation with guaranteed accuracy, both indoor and outdoor even in extreme weather

- Specifications**
- Reading Accuracy 0.1 bar / 2 psi
  - Maximum Inlet Pressure 15 bar / 218 psi
  - Inflation Flow 500 l/min / 13 cfm
  - Operating Temperature -25 to 55 °C
  - Hose Length - 3.6m / 12ft
  - Tyre Valve Connection - Twin Clip-on
  - 0-174 psi / 0-12 bar

- Features**
- New Viewing Window - Larger window gives 20% greater field of viewing
  - Lighter Weight - Gauge body weighs 923g
  - Biomorphic Shape - Ergonomic - easier to use
  - New Valve Mechanism - Simplified 2 stage mechanism
  - New Piston and Seal Design - New design - less drag
  - Accuracy Standards - Tested to over 400,000 cycles at 100% accuracy
  - Meets EC 86/217 and compliant with EN12645:2014



**PCL Airforce Tyre Inflators**

21 in General Model 0.53 m / 21 in Twin hold-on 0-138 psi / 0-9.6 bar

- Specifications**
- Reading Accuracy 0.1 bar / 2 psi
  - Maximum Inlet Pressure 13.8 bar / 200 psi
  - Inflation Flow 500 l/min / 18 cfm
  - Operating Temperature -25 to 55 °C

- Features**
- Larger window gives user greater field of viewing
  - Light Weight construction - Gauge body weighs 923g, less work strain so easier for long or repetitive use
  - Ergonomic design - more comfortable to use
  - New Valve Mechanism - Simplified design prevents user having to "push" against full line pressure on deflate preventing fatigue
  - New Piston and Seal Design - New design, less drag, reduced friction and less movement
  - Accuracy Standards - Tested to over 400,000 cycles at 100% accuracy, meets EC 86/217 and compliant with EN12645:2014

Part No.	Description
AFG43	Twin Hold On
AFG44	Single Clip on
AFG45	1.8m Hose and Twin Clip on
AFG46	2.7m Hose and Twin Clip on



**PCL Digital Tyre Inflators**

Offering leading inflation and deflation rates with high performance for both indoor and outdoor applications

- Features**
- Max Inflation Pressure 250 psi / 17.2 bar / 1723 kPa
  - Max Inlet Pressure 260 psi / 18.0 bar / 1795 kPa
  - Inflation Flow (@ 190 psi / 13 bar) 500 l/min / 18 CFM
  - Higher pressure range for multiple applications
  - Long accurate life expectancy
  - Fast to use and handle
  - Large screen - Easy and quick to read - Increasing accuracy and speed of use
  - Guaranteed accuracy
  - Long battery life - 400 hours of use
  - 3 units of calibration toggle as standard - psi, bar and kPa
  - IP54 - can be used indoors and outdoors
  - Auto off after 25 seconds
  - Battery Type 2 x AAA (supplied) compliant with EN12645:2014

Part No.	Description
ADAC43	Digital Tyre Inflator - Twin Hold On
ADAC44	Digital Tyre Inflator - Single Clip On
ADAC45	Digital Tyre Inflator - Twin Clip On
ADAC46	Digital Tyre Inflator - Twin Clip On



## JAMEC TDR 3000 Digital Tyre Inflator ATDR30

Redesigned to make it more compact with a larger LCD display

### Features

- Multi-scale gauge - p.s.i., kPa, bar
- Backlit display
- Inlet size 1/4" BSP
- Hose length 500 mm
- Wire sheathed hose eliminates kinking
- Accuracy exceeds EC Standards  $\pm 2$  p.s.i. @ 25 - 75 p.s.i.
- Supply pressure max. 200 p.s.i.
- Max. inflation 174 p.s.i.
- Powered by 2 x AAA (included)
- Supply pressure max. 200 p.s.i.
- Max. inflation 174 p.s.i.
- Powered by 2 x AAA (included)
- Advised application Industrial, workshops



**JAMEC PEM**  
RELIABLE SUPPORT YOUR BUSINESS PERFORMANCE

## JAMEC TDR 4000 Digital Tyre Inflator ATDR40

Lightweight and durable design with a one touch operation, makes this a quick and easy tyre inflator to use

Perfect for industrial workshops, mechanics and garages

### Features

- Auto on, upon sensing air pressure
- IP44 rating – tough, durable and resistant
- Large, tilted easy to read LCD display with backlight
- Auto off after 90 seconds
- Multi-scale gauge (bar, psi, kPa, kgF)
- Wire sheathed hose to eliminate kinking
- Supplied with certificate of calibration
- 80 hours continuous use
- 2 x AAA batteries included



**JAMEC PEM**  
RELIABLE SUPPORT YOUR BUSINESS PERFORMANCE

## Franklin 4 way Wheel Brace FB40

6 Point : 17 19 21mm - 1/2" sq dr

### Features

- Roll Marked Size For Easy Identification



1/2" 6PT

**FRANKLIN**  
 Professional Quality Tools



## XF Alloy Wheel Sockets

Supplied in industry approved EVA foam



See Section **B**

# Body Tools - Q

## Contents

Panel & Trim	Q2
Windscreen	O4
Radio & Airbag	O6

**FF Franklin & Co Ltd**

Platt Street

Sheffield

S3 8BQ

England

**Telephone**

0114 272 1429

**Facsimile**

0114 272 7030

**Email**

[orders@franklin-tools.co.uk](mailto:orders@franklin-tools.co.uk)

# 2020

[www.franklin-tools.co.uk](http://www.franklin-tools.co.uk)





## Dormer Spot Weld Drills

For the removal of spotwelds on body panels

### Features

- High speed Cobalt (HSCo) provides superior hot hardness when drilling
- Special lip and spur point provides good centering and high strength
- Short flute and zero body clearance ensures good stability when drilling by hand
- Bronze finish identifies Cobalt based substrate and reduces built up edge
- Primary for use in hand held applications



Part No.	Description
A7236	6 x 66mm
A723	8 x 79mm
A723+B	8 x79mm Boron Coated



## Franklin 4 pce Headlamp Adjustment Tool Set TA6373

4 piece set for the adjustment of headlamps

### Features

- Chrome Vanadium Steel
- 3 x 300 mm long blades
- Star 25
- 6 & 7mm Hexagon
- 2 position magnetic handle / bit holder
- In a plastic storage wallet
- Ergonomic 2 position Handle for comfort and grip



## Franklin 12 pce Panel Trim Removal Set BPRS

Trim removal tool kit for a wide range of applications

### Applications

Door trim panel, Trim fasteners and mouldings - including Facia, Hand Brake gaiters and many other internal and external vehicle trims

### Features

- Durable heavy duty plastic
- Will do the job efficiently without gouging and marring
- Supplied in a wallet roll



## Franklin 5 pce Trim Removal Tool Set TA635

For removing internal and external trim, fasteners, mouldings and other press fit parts eg. door trims, badges, wheel hubs etc

### Features

- Composite plastic fibre material
- Durable and flexible tools designed to minimise the risk of damage to mouldings, alloys or paintwork
- Also suitable for some scraping and cleaning operations



## Franklin Corrosion Assessment Tool (VOSA Approved)

### ACAT1

Suitable for checking condition of the chassis, brake pipes etc.

### Features

- Required for MOT work
- Improved design to help overcome cracking / breakage problems when accidentally dropped
- VOSA MoT approved
- Robust multi-functional tool



## Franklin Trim Clip Removal Pliers AT6429

Designed for the quick, safe removal of interior and exterior trims and logos and to prevent damage to interior and exterior surfaces.

### Features

- 240mm Length
- Spring loaded Pliers that provide better support under the clip head than conventional trim clip tools
- Wide nose for undoing facings without risk of breaking or tearing panels
- Finger guard to avoid injury
- For accessing difficult-to-reach places
- Ergonomic soft grip handles for comfort and ease of use



## Franklin Pro Wiper Arm Puller TA171

Adjustable design enables the tool to be securely located onto the wiper arm before starting to pull

### Features

- Heavy duty construction
- Swivel mounted thrust bearing and tommy bar
- Jaw opening 6 - 28 mm for wiper arms with an outside diameter up to 42mm
- Also suitable for use on some battery terminals and alternator bearings

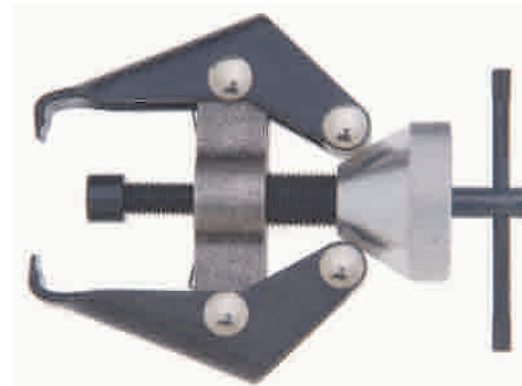

## Franklin Door Trim Panel Removal Tool TA64

For removing car trim panel retaining clips etc

### Features

- Ergonomic Handle for comfort in use



**Franklin Universal Lock Out Kit  
TA668**

Suitable for a wide range of European and Japanese vehicles

**Features**

- Comprehensive set - To gain entry to customers vehicle in an emergency
- Comes in a plastic storage wallet

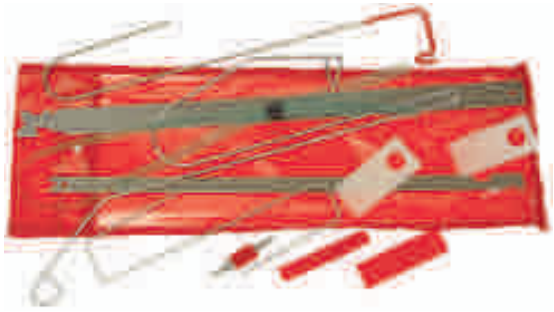

**Franklin Windscreen Removal Tool  
AW20**

Two self-locking T handles with 50 m of braided wire  
For bonded windscreens

**Features**

- Dipped Handles For Comfort and Grip

Part No.	Description
AW21	Spare Braided Wire (50 Metres)



**Franklin Flexible Dash Knife  
AW30**

Allows for deep cutting behind the dash

**Features**

- Blade is safely retained within a flexible copper sheath
- Complete with 5 blades
- Ergonomic Handle for comfort in use

Part No.	Description
AW31	Spare Blades (5)



**Franklin Diamond Lacing Tool Set (3)  
AW43**

For installing the filler strip on rubber gaskets

**Features**

- Small, medium and large tools
- Ergonomic Handles for comfort in use

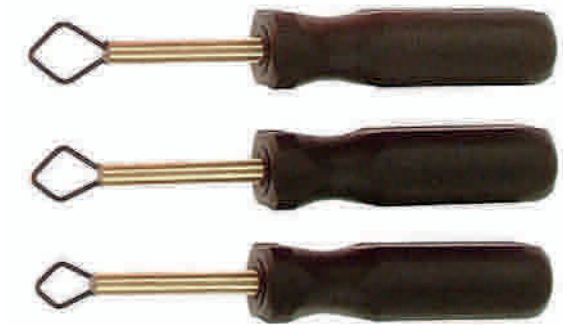

**Franklin Windscreen Cut Out Tool  
AW10**

For removing bonded screens and side panels

**Features**

- Dipped PVC Handles for Improved Comfort and Grip

Part No.	Description
AW11	Spare Cutting Blade



**Franklin Direct Wire Feeder  
AW22**

Enables the braided wire to be eased through the polyurethane  
on bonded windscreens

**Features**

- For use with AW20 / AW21
- Ergonomic Handle for comfort in use



**Franklin Plastic Dibber  
AW40**

To help with the installation of Windscreens etc

**Features**

- For back filling
- Use as a pry bar when removing
- Installing glass in rubber channels



**Franklin 2 pce Window Suckers  
AW44**

Holds winder window glass in position

**Features**

- Sturdy suction cups



## Franklin Air Bag Removal Tool

### TA630

Specialised tool kit for removing air bags

#### Applications

VW Passat, Jetta, Golf, Beetle Drivers air bag (1999-2004), VW Passat B, Polo, Lupo, VW Golf IV, Beetle, VW Golf IV (1998-2004), Bora (1999 on), Passat (1997 on), VW Passat (2000 on)

Audi A4 A6

Skoda Superb, Skoda Fabia, Octavia

Seat

Ford

Mercedes

GM Opel

Later BMW

#### Features

- Tough Impact Resistant Storage Case

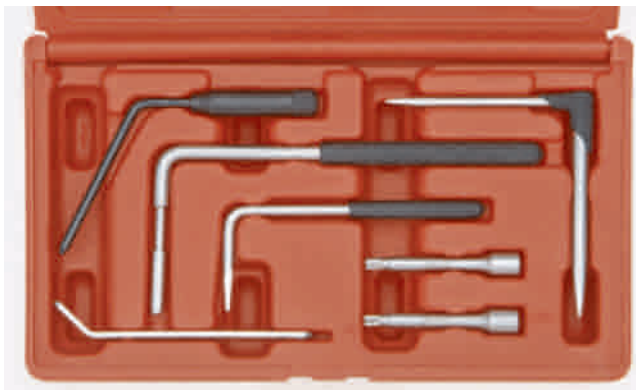

FRANKLIN  
Professional Quality Tools

## Franklin 32 pce Radio Removal Tool Set

### ARRT2

Folding Radio Removal Set Ideal for a wide number of popular models

#### Applications

Blaupunkt, Clarion Kenwood, Sony, Audi/VW, BMW, Fiat, Ford, Land Rover, Mercedes, GM Opal, Porsche, Skoda etc.

#### Features

- Comprehensive set to cover a wide range
- Handy penknife style design



FRANKLIN  
Professional Quality Tools

## Franklin 20 pce Franklin Radio Removal Tool Set

### TA649

For removal of radios for servicing etc

#### Applications

Ford, Volkswagen, Audi, Grundig, Blaupunkt, BMW, Mercedes Benz, Porsche, Becker, Opel, New Beetle, New Becker, New Skoda, New Blaupunkt, JVC, PIONEER

#### Features

- Supplied in a plastic storage wallet



FRANKLIN  
Professional Quality Tools



# Protection - R

## Contents

Gloves	R2
Knee Pads	R4
Personal	R4
Seat Covers	R5

**FF Franklin & Co Ltd**

Platt Street

Sheffield

S3 8BQ

England

**Telephone**

0114 272 1429

**Facsimile**

0114 272 7030

**Email**

[orders@franklin-tools.co.uk](mailto:orders@franklin-tools.co.uk)

# 2020

[www.franklin-tools.co.uk](http://www.franklin-tools.co.uk)



**H5 Pro Poseidon Gloves**

For any task to be done in a wet environment

**Features**

- Neoprene structure allows hand temperature to be kept for longer thanks to the thermal screen effect
- Patches in palm increase grip capacity

Part No.	Description
A0046L	Large
A0046X	X Large



**HEAVY DUTY**  
**H5**  
Pro

**H5 Pro I-Winter Work Gloves**

Winter work gloves

**Features**

- Use your smart phone or tablet with your gloves on
- Optimum comfort with breathable windproof fabric

Part No.	Description
A317M	Medium
A317X	X Large



**H5**  
Pro

**H5 Pro Vesuvius Gloves**

14" Leather MMA welding glove with anti-cut properties

**Features**

- Extra thickness gives added protection against sparks/anti-cut
- Anti-puncture protection

Part No.	Description
A6501L	Large
A6501X	X Large



**HEAVY DUTY**  
**H5**  
Pro

**H5 Pro Monte Carlo Gloves**

Ideal for Mechanics / precision assembly, driving

**Features**

- Breathable and comfortable
- Good grip with dexterity
- High Visibility Back
- EN388 2121

Part No.	Description
A8247L	Large
A8247X	X Large



**H5**  
Pro

**Irwin Workgloves**

For harsh applications and rough materials

**Features**

- TechnoGrip® reinforced thumb, palm and fingertips for extra durability and protection
- Knuckles padded with perforated Neoprene
- One-hand strap adjustment

Part No.	Description
A03826	Large
A03827	X Large



**HEAVY DUTY**  
**IRWIN**  
Industrial Tools

**H5 Pro Akab PVC Gloves**

Ideal for handling moist materials/hydrocarbons/grease

**Features**

- 30cm long PVC glove with cotton base
- Anti-slip granulated PVC palms
- Resistance to abrasion

Part No.	Description
A4010L	Large
A4010X	X Large



**H5**  
Pro

**H5 Pro Kraftwerk Gloves**

Specific protection for holding tools

**Features**

- Clarino synthetic leather palm with PU double palm and fingertips
- Two layers Bignet back with Nova knuckle improves flexibility
- High visibility back

Part No.	Description
A7621L	Large
A7621X	X Large



**H5**  
Pro

**Large Thermal Impact Reducing Glove**

DORSAL IMPACT-REDUCING GLOVES

**Features**

- Moulded TPR armour for full dorsal impact protection
- Patented "Flex-Zones" reduce hand fatigue
- Foam Rubber gripping palm stays flexible in cold
- Thermal acrylic fleece seamless knit
- Hi-Vis for hand safety awareness and signalling



Part No.	Description
B921L	Large Thermal Impact Reducing Glove
B921XL	X-Large Thermal Impact Reducing Glove

## Irwin Kneepads - I-GEL A03830

Comfortable kneepads with impact resistant I-Gel inserts

- Features**
- Embedded I-Gel insert provides maximum impact resistance
  - Non-marking cap will not damage delicate surfaces
  - Avoids slipping - Cap made of non slip materials
  - Breathable perforated neoprene straps
  - Excellent fit and stability
  - Adjustable sizing pads on both sides



## Irwin Kneepads - Swivel Flex A03832

Convex cap design provides greater manoeuvrability across textured surfaces

- Features**
- Ideal for use on textured surfaces, such as carpets
  - Flexible materials provide better fit
  - Front Strapping system for easy fastening
  - Double straps for comfort and safety
  - Does not restrict blood flow during use
  - Convex cap provides less resistance



## Irwin Kneepads - All Terrain A03831

Wide-body keeps stance more stable on uneven surfaces

- Features**
- All Terrain Kneepads
  - Absorbs shock with foam cushion under the cap
  - Breathable perforated neoprene straps
  - Double Straps for comfort and safety
  - Does not restrict blood flow during use



## Franklin 4 pce General Safety Set TA860

Keeping you safe in the work environment

- Features**
- Safety Goggles (conform to EN166:1995)
  - Ventilated frame with a one piece polycarbonate lens
  - Protects against low velocity impacts
  - Ear Defenders (conform to EN352-1:1993)
  - Protects against high noise levels
  - Dust Masks (conform to EN149:2001)
  - Protects from coarse non toxic dust and powder particles
  - Work Gloves (medium/large size)
  - Slip resistant grip



## Disposable Coveralls

For use to protect clothing

- Features**
- Resistant to Oil, Paint, Mud, Dust, Food and Drink
  - Anti-statically treated to EN1149-1, EN1073-2 for protection against radioactive particles
  - EN14126 for resistance to infective agents
  - Meets the requirements of CE Category III, Type 5 & 6



Part No.	Description
APS2M	70 kg Medium
APS2L	95 kg Large
APS2XL	100 kg Xlarge
APS2XX	124 kg XXLarge

## Winged Front Seat Covers

Extremely strong, heavy duty, water resistant seat covers

- Features**
- Made from super tough hardwearing 210 denier nylon with waterproof PVC backing
  - 100% waterproof
  - Resistant to: Mud, water, slurry, grease, oil, paint and dust etc
  - Easily wiped clean
  - Elasticated base and Velcro sides for easy fitment
- Please note - This seat cover is not suitable for use in vehicles with seat mounted airbags



Part No.	Description
HDB221	Black
HDG224	Grey



## Universal Front Seat Covers

Extremely strong, heavy duty, water resistant seat covers

- Features**
- Made from super tough hardwearing 210 denier nylon with waterproof PVC backing
  - 100% waterproof
  - Resistant to: Mud, water, slurry, grease, oil, paint and dust etc
  - Easily wiped clean
  - Elasticated base and Velcro sides for easy fitment
- Please note - This seat cover is not suitable for use in vehicles with seat mounted airbags



Part No.	Description
HDB201	Black
HDG204	Grey



## Universal CV Double Seat Cover Black

Extremely strong, heavy duty, water resistant seat covers

- Features**
- Made from super tough hardwearing 210 denier nylon with waterproof PVC backing
  - 100% waterproof
  - Resistant to: Mud, water, slurry, grease, oil, paint and dust etc
  - Easily wiped clean
  - Elasticated base and Velcro sides for easy fitment
- Please note - This seat cover is not suitable for use in vehicles with seat mounted airbags



Part No.	Description
HDB291	Black
HDG294	Grey





# Heavy Duty Seat Covers

Extremely strong, heavy duty, water resistant seat covers

**Features**

- Made from super tough hardwearing 210 denier nylon with waterproof PVC backing
- 100% waterproof
- Resistant to: Mud, water, slurry, grease, oil, paint and dust etc
- Easily wiped clean



**HEAVY DUTY**

Part No.	Description
HDB201	Universal Front Seat Cover Heavy Duty Black
HDG204	Universal Front Seat Cover Heavy Duty Grey
HDB211	Airbag Compatible Seat Cover Black
HDG214	Airbag Compatible Seat Cover Grey
HDB221	Winged Front Seat Cover Heavy Duty Black
HDG224	Winged Front Seat Cover Heavy Duty Grey
HDB225	Universal XL Winged Front Seat Black
HDG228	Universal XL Winged Front Seat Grey
HDB271	Adjustable Rear Seat Cover Heavy Duty Black
HDG274	Adjustable Rear Seat Cover Heavy Duty Grey
HDB291	Universal Van Double Seat Cover Black
HDG294	Universal Van Double Seat Cover Grey
HDB311	Technician's Seat Cover Heavy Duty Black
HDG314	Technician's Seat Cover Heavy Duty Grey
HDB231	Universal Truck Seat Cover - Black
HDG234	Universal Truck Seat Cover - Grey
HDB235	Universal Truck Double Seat - Black
HDG238	Universal Truck Double Seat - Grey
HDB351	Ford Transit 2002-05 Drivers Seat Black
HDG354	Ford Transit 2002-05 Drivers Seat Grey
HDB361	Ford Transit 2002-05 Passenger Double Seat Black
HDG364	Ford Transit 2002-05 Passenger Double Seat Grey
HDB501	Ford Transit Drivers Seat Cover Heavy Duty Black



Part No.	Description
HDG504	Ford Transit Drivers Seat Cover Heavy Duty Grey
HDB511	Ford Transit Double Seat Cover Heavy Duty Black
HDG514	Ford Transit Double Seat Cover Heavy Duty Grey
HDB721	Ford Transit Passenger Double Seat Black
HDG724	Ford Transit Passenger Double Seat Grey
HDB651	Ford Transit Drivers Seat Black
HDG654	Ford Transit Drivers Seat Grey
HDB661	Ford Transit Custom Double Seat Cover Black
HDG664	Ford Transit Custom Double Seat Cover Grey
HDB701	Ford Transit Connect 2014 Onwards 3/4 Passenger Seat Black
HDG704	Ford Transit Connect 2014 Onwards 3/4 Passenger Seat Grey
HDB781	Ford Transit Connect 2014 Onwards Front Drivers Seat Cover Black
HDG784	Ford Transit Connect 2014 Onwards Drivers Seat Grey
HDB705	Ford Transit Connect 2019 Onwards 3/4 Passenger Seat Black
HDG708	Ford Transit Connect 2019 Onwards 3/4 Passenger Seat Grey
HDB785	Ford Transit Connect 2019 Onwards Driver Seat Black
HDG788	Ford Transit Connect 2019 Onwards Driver Seat Grey
HDB801	Transit Courier 2014 Onwards Drivers Seat Black
HDG804	Ford Transit Courier 2014 Onwards Drivers Seat Black
HDB811	Ford Transit Courier 2014 Onwards Front Passenger Seat Cover Black
HDG814	Ford Transit Courier 2014 Onwards Front Passenger Seat Cover Grey
HDB805	Ford Transit Courier/Fiesta 2019 Onwards Driver Seat Black
HDG808	Ford Transit Courier/Fiesta 2019 Onwards Driver Seat Grey
HDB815	Ford Transit Courier/Fiesta 2019 Onwards Passenger Seat Black
HDG818	Ford Transit Courier/Fiesta 2019 Onwards Passenger Seat Grey
HDB571	Ford Ranger 2013 Onwards Driver Seat Black
HDG574	Ford Ranger 2013 Onwards Driver Seat Grey
HDB581	Ford Ranger 2013 Onwards Passenger Seat Black
HDG584	Ford Ranger 2013 Onwards Passenger Seat Grey
HDB611	Ford Ranger 2013 Onwards Rear Seat Black
HDG614	Ford Ranger 2013 Onwards Rear Seat Grey
HDB571	Ford Ranger 2016 Onwards Driver Seat Black
HDG574	Ford Ranger 2016 Onwards Driver Seat Grey
HDB581	Ford Ranger 2016 Onwards Passenger Seat Black
HDG584	Ford Ranger 2016 Onwards Passenger Seat Grey
HDB601	Ford Ranger 2016 Onwards Rear Seat Black
HDG604	Ford Ranger 2016 Onwards Rear Seat Grey
HDB621	Renault Traffic 2006-13 Driver Seat Black
HDG624	Renault Traffic 2006-13 Driver Seat Grey
HDB631	Renault Traffic 2006-13 Passenger Seat Black
HDG634	Renault Traffic 2006-13 Passenger Seat Grey

Please visit our website for full details - [www.franklin-tools.co.uk](http://www.franklin-tools.co.uk)

Please visit our website for full details - [www.franklin-tools.co.uk](http://www.franklin-tools.co.uk)



Part No.	Description
HDB851	Renault Trafic 2014 Onwards Driver Seat Black
HDG854	Renault Trafic 2014 Onwards Driver Seat Grey
HDB861	Renault Trafic 2014 Onwards Passenger Seat Black
HDG864	Renault Trafic 2014 Onwards Passenger Seat Grey
HDB421	Renault Master 2010/16 Onwards Drivers Seat Cover Black
HDG424	Renault Master 2010/16 Onwards Drivers Seat Cover Grey
HDB451	Renault Master 2010/16 Onwards Passenger Seat Black
HDG454	Renault Master 2010/16 Onwards Passenger Seat Grey
HDB461	Renault Kangoo 2016 Onwards Driver Seat Black
HDG464	Renault Kangoo 2016 Onwards Driver Seat Grey
HDB471	Renault Kangoo 2016 Onwards Passenger Seat Black
HDG474	Renault Kangoo 2016 Onwards Passenger Seat Grey
HDB881	Vauxhall Vivaro 2014 Onwards Driver Seat Black
HDG884	Vauxhall Vivaro 2014 Onwards Driver Seat Grey
HDB891	Vauxhall Vivaro 2014 Onwards Passenger Seat Black
HDG894	Vauxhall Vivaro 2014 Onwards Passenger Seat Grey
HDB481	Vauxhall Movano 2010 and 2016 Onwards Driver Seat Black
HDG484	Vauxhall Movano 2010 and 2016 Onwards Driver Seat Grey
HDB491	Vauxhall Movano 2010 Onwards Passenger Seat Black
HDG494	Vauxhall Movano 2010 Onwards Passenger Seat Grey
HDB481	Vauxhall Movano 2010 and 2016 Onwards Driver Seat Black
HDG484	Vauxhall Movano 2010 and 2016 Onwards Driver Seat Grey
HDB591	Vauxhall Movano 2016 Onwards Double Passenger Seat Black
HDG594	Vauxhall Movano 2016 Onwards Double Passenger Seat Grey
HDB981	Peugeot/Citroen Partner/Berlingo Driver Seat Black
HDG984	Peugeot/Citroen Partner/Berlingo Driver Seat Black
HDB991	Peugeot/Citroen Partner/Berlingo Passenger Seat Black
HDG994	Peugeot/Citroen Partner/Berlingo Passenger Seat Grey
HDB921	VW Crafter 2014-16 Driver Seat Black
HDG924	VW Crafter 2014-16 Driver Seat Grey
HDB931	VW Crafter 2014-16 Passenger Seat Black
HDG934	VW Crafter 2014-16 Passenger Seat Grey
HDB901	Mercedes Sprinter 2015 Onwards Front Drivers Seat Cover
HDG904	Mercedes Sprinter 2015 Onwards Front Drivers Seat Cover
HDB911	Mercedes Sprinter 2015 Onwards Passenger Van Double Seat Cover
HDG914	Mercedes Sprinter 2015 Onwards Passenger Van Double Seat Cover
HDB321	Tractor / Plant 1 Seat Cover Black - Black
HDG324	Tractor / Plant 1 Seat Cover Black - Grey
HDB331	Tractor / Plant 1 Seat Cover Black
HDG334	Tractor / Plant 1 Seat Cover Grey
TA657	Franklin Seat Cover Set

Please visit our website for full details - [www.franklin-tools.co.uk](http://www.franklin-tools.co.uk)

# Timing Sets - S

## Contents

Alfa Romeo	S2
BMW	S3
Citroen	S8
Chrysler / Jeep	S10
Dacia	S11
Fiat	S11
Ford	S14
Jaguar	S17
Land Rover	S18
Mazda	S20
Mini	S21
Nissan	S22
Peugeot	S22
Renault	S24
SAAB	S26
Suzuki	S27
VAG	S27
Vauxhall	S34
Volvo	S36
General	S37

2020

[www.franklin-tools.co.uk](http://www.franklin-tools.co.uk)





**Franklin Alfa Romeo 0.9 Twin Air  
AT4609**

Applications:  
Mito  
Engine Codes:  
• 0.9: 312A2.000  
OEM Ref:  
2.000.035.300 • 2.000.035.200 • 2.000.035.100



Chain



**Franklin Alfa Romeo 1.3 JTD Diesel  
TA553**

Applications:  
Mito  
Engine Codes:  
• 1.3DJDTM: 199A3.000, 199B1.000  
OEM Ref:  
1.871.000.900 • EN-46785 • KM6131



Chain



**Franklin Alfa Romeo 1.2, 1.4, 1.4 T-Jet 16 V Petrol  
AT4612**

Applications:  
Giulietta, Mito  
Engine Codes:  
• 1.2 16v: 176B9.000, 182B2.000, 188A5.000  
• 1.4 16v: 843A1.000, 169A3.000  
• 1.4 16v/T-Jet: 169A3.000, 192B2.000, 198A1.000, 198A4.000, 199A6.000, 199A8.000, 843A1.000  
OEM Ref:  
2.000.004.500 • 1.860.985.000 • 1.860.992.000  
1.860.987.000 • 2.000.015.800



Belt



**Franklin Alfa Romeo 1.6 - 2.4 Diesel  
AT4098**

Applications:  
145, 146, 147, 156, 159, 166, Brera, Crosswagon, Giulietta, GT, Mito, Spider  
Engine Codes:  
• 1.9JTD 8v: 323.02, 371.01, 182B9.000, 937A2.000, 939A1.000, 939A2.000, 939A7.000  
• 1.9JTD 16v: 192A5.000, 192B1.000, 937A4.000, 937A5.000, 939A2.000, 939A8.000  
• 2.4JTD 10v: 325.01, 342.02, 362.02, 839A6.000, 841C.000  
• 2.4JTD 20v: 841G.000, 841H.000, 841M.000, 939A3.000  
OEM Ref:  
1.860.898.000 • 1.870.896.900 • 1.860.905.000  
1.860.905.010 • 2.000.003.000 • 1.860.965.000



Belt



**Franklin Alfa Romeo 1.8MPI Petrol  
AT4502**

Applications:  
159  
Engine Codes:  
• 1.8MPI: 939A4.000  
OEM Ref:  
2.000.012.000 • 2.000.012.100 • KM-6333  
2.000.012.800 • KM-6349 • KM-6130 • KM-911

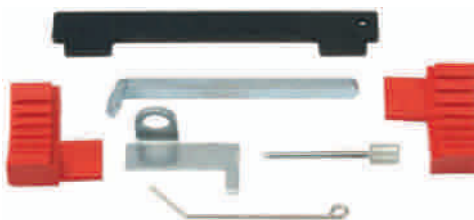

Belt



**Franklin BMW M42 M44 M50 M52 M52(TU) M54 M56  
AT4114**

Applications:  
• 1.8, 2.0, 2.3, 2.5, 2.8  
• DOHC petrol (chain): 318iS, 318ti, 320i, 323i, 325i, 328i, 330i, 520i, 523i, 525i, 528i, 728i, 730i, X3, X5, Z3, Z4  
Engine Codes:  
M42, M44, M50, M52 (no VANOS (VVT) M50 M52 Single VANOS (VVT) M52TU M54 M56 Twin VANOS (VVT)  
OEM Ref:  
112.300 • 113.240 • 113.290 • 113.292 • 113.390 • 114.220 • 119.110



Chain



## Franklin BMW N40, N45, N45T - B16, B16AC Petrol AT4118

Applications:  
116 E81/82/87/88, 316i/ti Compact E46, 316i E90/91/92/93

Engine Codes:  
• 1.6: N40, B16A, N45, B16A, N45T, B16AC

OEM Ref:  
117 260 • 117 250 251 • 117 250 252 • 119 340  
117 253 • 119 190 • 115 120



Chain



## Franklin BMW 1.6, 2.0, N43 Petrol AT4113

Applications:  
116, 118, 120 (E81, E82, E87, E88), 316, 318,  
320 (E90, E91, E92, E93), 520 (E60, E61)

Engine Codes:  
• 1.6: B16A/AA, B16AA, B16AA/OO  
• 2.0: B20A, B20A/AA, B20AA, B20AY, B20K0, B20U0

OEM Ref:  
11 8 690 • 11 8 691 • 11 8 692 • 11 8 693 • 11 8 710  
11 8 711 • 11 8 712 • 11 3 340 • 11 8 700 • 11 5 120  
11 9 340 • 11 9 341 • 11 9 342

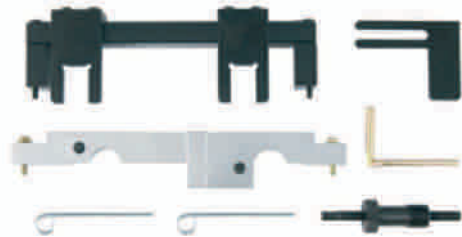

Chain



## Franklin BMW 2.0, 2.3, 2.5, 3.0 Twin Vanos Petrol AT4115

Applications:  
For use with VANOS variable valve/timing units on six cylinder BMW engines. Designed for dismantling/assembling and timing of the unit after engine overhaul/repair work. Kit includes Twin VANOS Setting Tool, Sprocket/chain Assembly Fixture and Compressed Air Connector

Engine Codes:  
• 11 6 180 : M52TU, M54, M56 (3 series E46, 5 series E39/E60/E61, 7 series E38/E65/E66, X3 E83 X5 E53, Z3, Z4 E85)  
• 11 6 150 : M52TU, M54, M56  
• 11 5 490 : M50, M52 (3 series E36/E46, 5 series E34/39, 7 series E38, Z3)  
• 11 3 450 : M50, M52, M52TU, M54, M56  
• 11 3 292 : M52, M52TU, M54, M56  
• 11 3 291 : M50 (3 series E36, 5 series E34)  
• 11 3 390/11 4 220 : M50, M52, M52TU, M54, M56



Chain



## Franklin BMW 2.0, N20, N26 Petrol AT4126

Applications:  
• 1 Series: 125i  
• 3 Series: 320i X-Drive, 328i, 328i X-Drive  
• 5 Series: 520i, 528i X-drive  
• X1: X-Drive 20i, S-Drive 20i, X-Drive 28i • X3: 20i, X-Drive 20i  
• Z4: S-drive 20i (11-14), S-drive 28i (11-14)

Engine Codes:  
• N20B20A  
• N20B20  
• N26B20  
• N20B20/UO

OEM Ref:  
8302212 831 • 83302212830 • 2219548 • 11 9 340

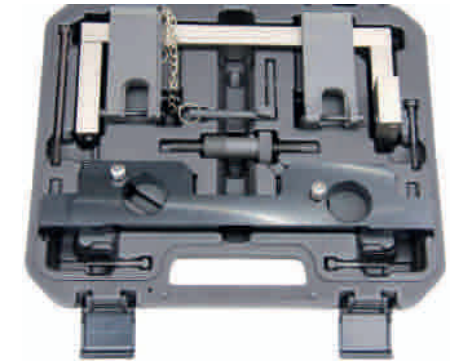

Chain



## Franklin BMW N51 N52 N52K N53 N54 Petrol AT4116

Applications:  
• 1 Series: 125i E88, 128i E82/88, 130i E81/E87, 135i/S E82, M Coupe  
• 3 Series: 323i E90/91/92/93, 325i/xi E90/91/92/93, 328i/xi E90/91/92/93, 330i/xi E90/91/92/93, 335i/xi  
• 5 Series: 523/Li E60/61, F10/11, 525i/Li/xi E60/61, 528i/xi E60/61, F10/11, 530i/Li/xi E60/61, F10/11, 535i/xi E60/61  
• 6 Series: 630i E63/64  
• 7 Series: 730i E65/66, F01/02/04, 740i F01/02/04  
• X Series: X1 3.0 xDrive25i E84, X1 3.0 xDrive28i E84, X3 2.5Si E83, X3 3.0i/Si E83, X3 3.0 xDrive28i F25, X5 3.0Si/xDrive30i E70, X6 3.0xDrive35i E71/72  
• Z Series: Z4 2.5i/Si E85/86, Z4 3.0i/Si E85/86, Z4 2.5 sDrive23i E89, Z4 3.0 sDrive30i E89, Z4 3.0 sDrive 35i/is E89

Engine Codes:  
• N51/N52/N52K Valvetronic: B25A, B25A/O1, B25AE, B25AF, B25BE, B2501, B2502, B25U1, B30/O2, B30A, B30A/O1, B30AE  
• N53/N54 direct injection B30A/AA, B30A/O0, B30A/T0, B30O0, B30TD, B30U0

OEM Ref:  
11 4 280 • 11 4 281 • 11 4 282 • 11 4 283 • 11 4 290 • 11 0 300 • 11 8 520  
(includes Vanos alignment plates)

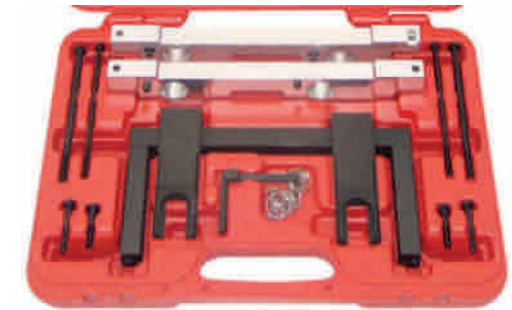

Chain



## Franklin BMW 1.6 N13, N18 Petrol AT4124

Applications:  
114i, 116i, 118i, 316i

Engine Codes:  
• N13 B16A • N18 B16/M0 • N18 B16A/M0

OEM Ref:  
11 7 440 • 11 7 440 • 11 9 340 • 496 709 • 11 9 590



Chain

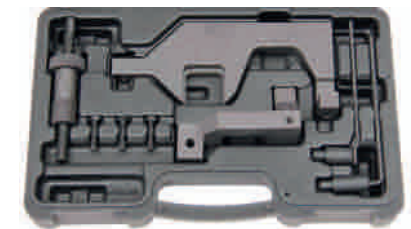



## Franklin BMW Chain Service Tool Kit

### AT4120

#### Applications:

- 1 Series: 116 (E811, E87), 118 (E87), 120 (E87) Valvetronic 128i (E82)
  - 3 Series: 316 (E46), 316ti Compact (E46), 318i (E46), 316 (E46, E90), 316Ci (E46), 316ti (E46), 318 Compact (E46), 318i (E90), 320 (E90), Direct Injection Non-Valvetronic 323i (E90, E911, E92, E93), 325 (E90, E911, E92, E93), 328 (E90, E911, E92, E93), 330 (E90, E911, E92, E93), 335 (E90, E911, E92, E93)
  - 5 Series: 520 (E60), 523 (E60, E61), 525 (E60, E61), 528 (E60, E61), 530 (E60, E61), 535 (E601, E61), 630 (E63, E64), 730 (E65, E66)
  - X Series: X3 2.0 (E83), X3 2.5/3.0 (E83), X5 3.0 (E70), 130 (E811, E87), 135 (E82)
  - Z Series: Z4 2.0 (E85), Z4 2.5/3.0 (E85, E86)
- Engine Codes: • N40 / N45 N45T B16 • N42 / N46 B18, B18A, B20, B20A, B20B • N51 / N52 / N52K / N53 / N54 Valvetronic  
• N53 / N54 Direct Injection Non-Valvetronic
- OEM Ref: 11.9.330 • 11.5.140 • 11.9.280 • 11.4.360 • 11.3.340  
• 11.9.340 • 11.9.341



Chain



## Franklin BMW N62 N62TU V8 - N73 V12 Petrol

### AT4122

#### Applications:

- 5 Series: 540i E60/61, 545i E60/61, 550i E60/61
  - 6 Series: 645i E63/64, 650i E63/64
  - 7 Series: 735i E65/66, 740i E65/66, 745i E65/66, 750i E65-66, 760i E65/66
  - X Series: X5 4.4 E53, X5 4.8 E53/E70
- Engine Codes:  
• 3.6L: N62 B36A • 4.0L: N62 B40  
• 4.4L: N62 B44/A • 4.8L: N62 B48/A/B • 6.0L: N73 B60A
- OEM Ref: 11 9 461 • 11 9 462 • 11 9 463 • 11 9 190



Chain



## BMW 1.8, 2.0, N42, N46, N46T Petrol

### AT4117

#### Applications:

- 1 Series: 118i E81/82/87/88, 120i E81/82/87/88
  - 3 Series: 316ti Compact E46, 318i/ti Compact E46, 318i E90/91/92/93, 320i E90/91/92/93
  - 5 Series: 520i E60/61 • Z Series: Z4 2.0 E85/E86
  - X Series: X1 sDrive 18i E84, X1 xDrive 18i E84, X3 2.0 E83
- Engine Codes:  
N42: B18A, B20A • N46: B18, B20, B20B O2 • N46T: B20, B20BZ
- OEM Ref: 11 2 300 • 11 9 190 • 11 9 340 • 11 9 292 • 11 9 350 • 11 9 290 • 11 9 293



Chain



## Franklin BMW 2.0D M47 & 3.0D M57 Diesel Pump Sprocket Tool

### TA419

#### Applications:

- 318d Compact (E46) 320d/tid Compact (E46) - 330d (E46) 525d (E39)  
525d E60/E61) 530d (E39) - 530d (E60/E61) 535d (E60/E61) 730d (E38)  
X5 3.0d (E53) Landrover Freelander (Td4) Rover 75 (M47)
- Engine Codes: BMW M47, M47TU, M57, M57TU engines
- OEM Ref: 13.5.190/1/2 • LRT 12-178



Chain



## Franklin BMW 2.0D, 2.5D, 3.0D M47, M57 Diesel

### TA416

#### Applications:

- 1 Series: 118D, 120D (E87)
  - 3 Series: 318 320 330 (E46), 318 320 325 330 335 (E90, E91)
  - 5 Series: 520 525 530 (E39), 520 525 530 535 (E60, E61)
  - 6 Series: 635 (E63, E64)
  - 7 Series: 730 (E38), 730 (E65, E66)
  - X Series: X3 (E83), X5 (E53, E70), X6 (E71, E72)
- Engine Codes:  
• 2.0D: 20 4D 1, 20 4D 4 • 2.5D: 25 6D 1  
• 3.0D: 30 6D 1, 30 6D 2, 30 6D 3, 30 6D 4, 30 6D 5
- OEM Ref:  
11 2 300 • 11 6 320 • 11 6 322 • 11 3 340 • 11 5 180 • 11 6 080



Chain



## Franklin BMW 2.0D N47, N57, N47S Diesel Pump Sprocket Tool

### TA418

#### Applications:

- 116D (E81, E82, E87), 118D (E81, E82, E87), 120D (E81, E82, E87), 123D (E81, E82, E87), 316D (E90), 318D (E90), 320D (E90, E91, E92, E93), 520D (E60), 520D (F10, F11), X1 (E84), X3 (E83), X3 (F25)
- Engine Codes:  
• 2.0: N47 D20, N47 D20A, N47S
- OEM Ref:  
115 320 • 118 760 • 116 480 • 118 740 • 113 340



Chain



## Franklin BMW 2.0D N47 N47S N57 1.6, 2.0, 3.0 Diesel

### AT4119

#### Applications:

- 1 Series: 114d F20/21, 116d E81/82/87/88 F20/21, 118d E81/82/87/88 F20/21, 120d E81/82/87/88, 120d/xDrive F20/21, 123d E81/82/87/88, 125d F20/21
  - 3 Series: 316d E90/91/92/93, 316d F30/31, 318d E90/91/92/93, 318d F30/31, 318d F30/31, 320d E90/91/92/93, 320d/EfficientDynamics E90/91/92/93, 320d/xDrive F30/31, 325d E90/91/92/93, 330d E90/91/92/93, 330d/xDrive E90/91/92/93
  - 5 Series: 520d E60/61, 520d F10/11, 520d/EfficientDynamics F10/11, 520d/xDrive F10/11, 525d F10/11, 530d F10/11, 530d/xDrive F10/11, 530dGT F07, 530d/xDrive GT F07, 535d F10/11, 535d/xDrive GT F07, 535d/xDrive F10/11, 535dGT F07
  - 6 Series: 640d/xDrive F12/13
  - 7 Series: 730d F01/02/04, 730d/Ld F01/02/04, 730d/xDrive F01/02/04, 740d F01/02/04, 740d xDrive F01/02/04 • M Series: M550d/xDrive F10/11
  - X Series: X1 E84, X1 F84, X1 sDrive 18d E84, X1 sDrive 20d E84, X1 xDrive 18d E84, X1 xDrive 20d E84, X1 xDrive 23d E84, X3 E83 2.0D, X3 F25, X3 F25, X3 xDrive 18d E83, X3 xDrive 30d E83, X5 E70 3.0D, X5 xDrive 40d E70, X6 E71/72, X6 xDrive 30d E71/72, X6 xDrive 40d E71/72
- Engine Codes:  
• N47/N47S: C16K1, C16U1, C20K1, C20U1, D16, D20A, D20A/OO, D20A/OU0, D20B, D20C, D20C/K1, D20C/O1, D20C/U1, D20D/T0, D20D/T1, D20O0, D20O1, D20C/O1, D20T0, D20U0, SD20B/D/T0, TD20K1, TD20U1  
• N57: D30A, D30A/OO, D30B/T0, D30C/S1, D30B/T0, D30O0, D30O1, D30T0, D30T0, D30U0, D30U0
- OEM Ref: 11.5.320 • 11.6.480 • 11.8.760 • 11.8.740 • 11.3.340 • 11.4.320

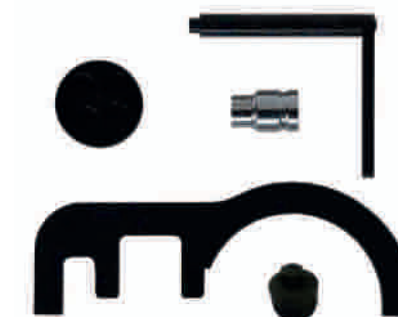

Chain





## Franklin BMW N47 N57 Crankshaft Holding Tool AT4121

### Applications:

- 1 Series: 114d F20/21, 116d E81/82/87/88 F20/21, 118d E81/82/87/88 F20/21, 120d E81/82/87/88, 120d/xDrive F20/21, 123d E81/82/87/88, 125D F20/21
- 3 Series: 316d E90/91/92/93, 316d F30/31, 318d E90/91/92/93, 318d F30/31, 318D F30/31, 320d E90/91/92/93, 320d/xDrive F30/31, 320d/EfficientDynamics E90/91/92/93, 320d/xDrive F30/31, 325d E90/91/92/93, 330d E90/91/92/93, 330d/xd E90/91/92/93
- 5 Series: 520d E60/61, 520d F10/11, 520d/EfficientDynamics F10/11, 520d/xDrive F10/11, 525d F10/11, 530d F10/11, 530d/xDrive F10/11, 530dGT F07, 530d/xDrive GT F07, 535d F10/11, 535d/xDrive GT F07, 535d/xDrive F10/11, 535dGT F07
- 6 Series: 640d/xDrive F12/13
- 7 Series: 730d F01/02/04, 730d/Ld F01/02/04, 730d/xDrive F01/02/04, 740d F01/02/04, 740d xDrive F01/02/04 • M Series: M550d/xDrive F10/11
- X Series: X1 E84, X1 F84, X1 sDrive 18d E84, X1 sDrive 20d E84, X1 xDrive 18d E84, X1 xDrive 20d E84, X1 xDrive 23d E84, X3 E83 2.0D, X3 F25, X3 F25, X3 xDrive 18d E83, X3 xDrive 30d E83, X5 E70 3.0D, X5 xDrive 40d E70, X6 E71/72, X6 xDrive 30d E71/72, X6 xDrive 40d E71/72

### Engine Codes:

- N47/N47S: C16K1, C16U1, C20K1, C20U1, D16, D20A, D20A/O0, D20A/OU0, D20B, D20C, D20C/K1, D20C/O1, D20C/U1, D20D/T0, D20D/T1, D20O0, D20O1, D20C/O1, D20T0, D20U0, SD20B/D/T0, TD20K1, TD20U1
- N57: D30A, D30A/O0, D30B/T0, D30C/S1, D30B/T0, D30O0, D30O1, D30T0, D30T0, D30U0, D30U0

OEM Ref:  
11.4.320



Chain



## Franklin Citroen 1.0 VTi/1.2 VTi Petrol AT4408

### Applications:

C3, C4, DS3

### Engine Codes:

- 1.0VTi: EBO (ZMZ), ZMZ (EBO)
- 1.2 VTi: HMZ (EB2), HMY (EB2M), EB2 (HMZ)
- 1.2 E-VTi: EB2F (HMZ), EB2 (HMZ)

### OEM Ref:

0109-2B • 0109-2A



Belt



## Franklin Citroen TU3/ET3 1.4 8v/16v Petrol AT4409

### Applications:

Berlingo I/II/First, C2, C3, C3 III, C3, C4, Saxo, Xsara I/II, Nemo

### Engine Codes:

- ET3J4 (KFU) • TU3A/JP/L3/L4 (KFT, KFV, KFW, KFX)

### OEM Ref:

- 4533-T.AC1 • 0132-AJ1 • 0189-B • 0187-B • 0188-M • 0194-B
- 0132-RZ • 4507-TB • 4507-TA • 0132-QY • 4200-TH • 0153-AL
- 4533-TAD • 0132-AK • 0188-K • 0153-AK • 0189-K • 0153-AE
- 0178-D • 0194-A • 0132-AB • 4527-TS2 • 5711-TD • 4507-TA • 0132-QY



Belt



## Franklin Citroen 1.4VTI, 1.6VTI, 1.6 (EP3 / EP6 / EP6DT / DTS) Petrol AT4411

### Applications:

Berlingo III, C3 III, C3 (Picasso), C4, C4 II, C4 Grand Picasso, C5 III, DS3 Racing, DS4, DS5

### Engine Codes:

- 1.4VTi: 8FP, 8FR, 8FS
- 1.6VTi: 5FK, 5FP, 5FS, 5FW
- 1.6: THP 5FD, 5FE, 5FM, 5FN, 5FR, 5FT, 5FV, 5FX

### OEM Ref:

Screws • 119-340 • 0197-B • 119-552 • 0197-A3 • 0197-A2 • 0197-A1



Chain



## Franklin Citroen 1.4, 1.6HDI Diesel TA433

### Applications:

Berlingo, C1, C2, C3, C4, Grand Picasso, C5, C5 III, Dispatch, Jumpy, Nemo, Xsara Picasso

### Engine Codes:

- 1.4 HDI: 8HR, 8HS, 8HT, 8HV, 8HW, 8HX, 8HY, 8HZ
- 1.6 HDI: 9HT, 9HU, 9HV, 9HW, 9HX, 9HY, 9HZ

### OEM Ref:

0194C • 0194A • 49JE02021



Belt



## Franklin Citroen DW8 DW10 DW12 Hdi Diesel Timing Set TA541

Applications:

- 1.9 : Xsara, Berlingo, Dispatch, Jumpy
- 2.0 : C4, C5, C8, DS4, Berlingo, Dispatch, Jumpy, Relay Synergie, Evasio Xantia Picasso, Grand Picasso
- 2.2 : C-Crosser, C5, C6, C8, Relay, Jumper

Engine Codes:

- 1.9 : DW8 (WJZ)
- 2.0 : DW10ATED4, DW10JATED4, DW10BTED/L3, DW10ATD, DW10TD, DW10ATED, D10BTED, DW10UTD, DW10TD, DW10CTED 4 RHA, RHE, RHF, RHG, RHH, RHJ, RHK, RHM, RHR, RHS, RHT, RHV, RHW, RHX, RHY, RHZ
- 2.2 : DW12MTED4, DW12BTED4, D12TED4/L4, DW12UTED, DW12ATEDL, L4, DW12CTED4, 4HK, 4HL, 4HN, 4HP, 4HR, 4HS, 4HT, 4HW, 4HX, 4HY, 4HZ

OEM Ref: 0188Y • 0188M • 0188X • 0188K • 0188F • 0188J2 • 0188P



## Franklin Citroen 2.7D, 3.0D TDV6/SDV6/TDVi/Hdi AT4910

Applications:

C5 III, C6

Engine Codes:

- 2.7D HDI: DT17BTED4 (UHZ)

OEM Ref:

0195-H • 0195-C • 0195-K • 0188-K



## Franklin Chrysler/Jeep, LDV 2.5D, 2.8D CRD Timing Set AT4490

Applications:

- Chrysler: Voyager, Grand Voyager
- Jeep: Cherokee
- LDV: Maxus

Engine Codes:

- 2.5D CRD: R2516C, R2516K, R2516L
- 2.8D CRD: R2816C5.05A, R2816K4

OEM Ref:

• VM 1052/LDV 192 • VM 1053/LDV 193 • VM 1068/LDV 196  
• VM 1080 • VM 8873 • VM 1056 • H2587



## Franklin Dacia 1.6L Petrol Engine TA422

Applications:

Duster, Logan, Sandero

Engine Codes:

- 1.6: K4M606, 616, 690, 696, 697

OEM Ref:

MOT 1489 • MOT 1054 • MOT 1496



## Franklin Fiat 0.9 Twin Air AT4609

Applications:

500, 500C, Panda, Punto

Engine Codes:

- 0.9: 312A2.000

OEM Ref:

2.000.035.300 • 2.000.035.200 • 2.000.035.100



## Franklin Fiat 1.2, 1.4 8V Petrol AT4624

Applications:

500 ( C ), Doblo, Idea, Florino, Grand Punto, Idea, Linea, Punto Evo, Panda, Qubo

Engine Codes:

- 1.2 8v: 169A4.000, 199A4.000
- 1.4 8v: 199A7.000, 350A1.000

OEM Ref:

• 2.000.004.500 • 2.190.754.500 • 2.000.004.400  
• 2.190.754.400 • 2.000.004.200 • 2.000.004.300 • 1.860.987.000

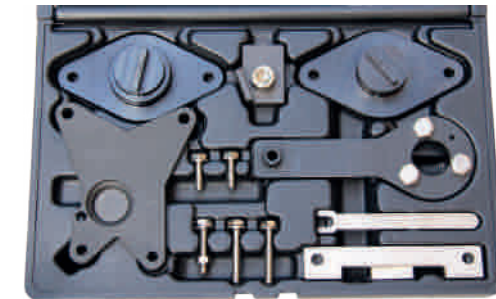

**Franklin Fiat 1.2, 1.4, 1.4 T-JET 16 V Petrol**  
**AT4612**

Applications:  
500, Bravo, Grande Punto, Grande Punto Abarth,  
Idea, Linea, Marea/Weekend, Palio Weekend, Panda, Punto, Stilo  
Engine Codes:

- 1.2 16v: 176B9.000, 182B2.000, 188A5.000
- 1.4 16v: 843A1.000, 169A3.000
- 1.4 16v/T-Jet: 169A3.000, 192B2.000  
198A1.000, 198A4.000, 199A6.000,  
199A8.000, 843A1.000

OEM Ref:  
• 2.000.004.500 • 1.860.985.000 • 1.860.992.000  
• 1.860.987.000 • 2.000.015.800



**Franklin Fiat 1.6 16V Petrol Timing Set**  
**TA466**

Applications:  
Brava, Bravo, Doblo, Marea, Multipla, Palio, Stilo, Weekend  
Engine Codes:

- 1.6 16V: 182A4.000 182A6.000 182B6.000

OEM Ref:  
1.860.874.000 • 1.860.771.000 • 1.860.876.000



**Franklin Fiat 1.8 16V Petrol**  
**AT4502**

Applications:  
Croma  
Engine Codes:  
• 1.8MPI: 939A4.000  
OEM Ref:  
• 2.000.012.000 • 2.000.012.100 • KM-6333  
• 2.000.012.800 • KM-6349 • KM-6130 • KM-911

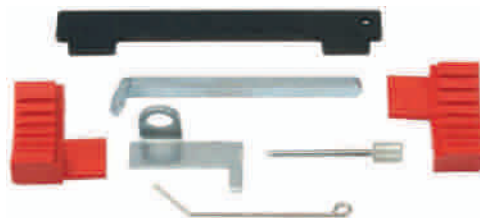

**Franklin Fiat 1.3 JTD Diesel**  
**TA553**

Applications:  
500 ( C ), Doblo, EVO, Fiorino, Grand Punto,  
Idea, Linea, Panda, Punto, Punto, Qubo, Strada  
Engine Codes:

- 1.3JTD: 169A1.000, 169A5.000, 199B1.000,  
188A8.000, 188A9.000, 199A2.000, 199A3.000,  
199A9.000, 199B2.000, 223A9.000, 263A2.000

OEM Ref:  
• 1.871.000.200 • 1.870.900.400 • 1.871.000.900  
• EN-46785 • KM-613 • 1.870.900.300



**Franklin Fiat 1.7D, 1.9D Diesel Timing Set**  
**TA467**

Applications:  
Ducato, Fiorina, Punto, Strada Pickup, Talento, Tipo, Bravo  
Engine Codes:

- 1.7D: 176B3.000
- 1.7D Turbo: 146D7.000, 176A3.000, 176A5.000
- 1.9D: 149B1.000, 160A7.000, 230A2.000
- 1.9D Turbo: 336.01, 675.01, 160A6.000, 160B6.046,  
160D1.000, 230A3.000, 230A4.00, 280A1.000

OEM Ref:  
• 1 860 933 000 • 1 860 932 000  
• 1 860 934 000 • 1 860 931 000 • 1 860 934 000





## Franklin Fiat 1.6, 1.9, 2.0, 2.4 Diesel

**AT4098**

Applications:

Brava, Bravo, Cromia, Doblo, Ducato, Evo, Grand Punto, Idea, Linea, Marea, Palio, Punto, Multipla, Sedici, Strada, Stilo, Weekend

Engine Codes:

- 1.6JTD: 198A2.000, 198A3.000, 198A6.000, 263A3.000, 263A4.000, 263A5.000, 350A2.000, 955A3.000
  - 1.9T/D: 182A7.000, 182A8.000, 188A3.000, 223A6.000
  - 1.9JTD: 182B4.000, 182B9.000, 186A6.000, 186A8.000, 186A9.000, 188A2.000, 188A7.000, 188B2.000, 192A1.000, 192A3.000, 192A8.000, 192A9.000, 192B4.000, 192B5.000, 199A5.000, 937A5.000, 939A1.000
  - 1.9D JT/DM: 186A9.000, 192A5.000, 192A8.000, 223A7.000, 223B1.000, 937A5.000, 939A1.000, 939A2.000, 939A7.000, 939A8.000, D19AA
  - 2.0JT/DM: 198A5.000, 250A1.000, 263A1.000, D20AA
  - 2.4JTDM: 185A2.000, 185A6000, 939A3.000
- OEM Ref:
- 1.860.898.000 • 1.870.896.900 • 1.860.905.000
  - 1.860.905.010 • 2.000.003.000 • 1.860.965.000



## Franklin Ford 1.2, 1.4 Petrol Engine Timing Set

**AT4624**

Applications:

Ka

Engine Codes:

- 1.2: AAAA
- OEM Ref:
- 303-1480 • 303-1479 • 303-1477 • 303-1478 • 1.860.987.000

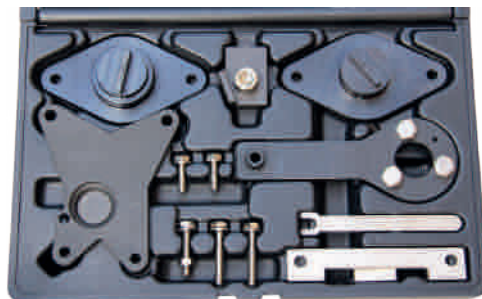

## Franklin Ford Master Timing Set

**AT4300**

Applications:

C-MAX, Cougar, Courier, Escort, Fiesta, Focus, Focus C-MAX, Fusion, Galaxy, Grand C-MAX, Kuga, Maverick, Mondeo, Orion, Puma, S-MAX, Tourneo Connect, Transit, Transit Connect

Engine Codes:

- 1.25 16v Belt: DHA, DHB, DHC, DHD, DHE, DHF, DHG, F8JA, F8JB, FUJA, FUJB, M7JA, M7JB, SNJA, SNJB, STJA, STJB
  - 1.4 16v Belt: ASDA, ASDB, FHA, FHB, FHD, FHF, FXDA, FXDB, FXDC, FXDD, FXJA, FXJB, FXJC, SPJA, SPJC, RTJA, RTJB, UTJA
  - 1.4D TDCi Belt: F6JA, F6JB, F6JC, F6JD, KVJA
  - 1.6 16v Belt: FYDA, FYDB, FYDC, FYDD, FYDH, FYJA, FYJB, FYJC, HWDA, HWDB, L1F, L1J, L1L, L1N, L1Q, L1T, L1V, L1W, SHDA, SHDB, SHDC
  - 1.6Ti-VCT Belt: HXJA, HXJB, HXDA, IQDA, IQDB, PNBA, PNDA, RHBA, SIDA
  - 1.5D TDCi Belt: UGJC, ENUG, UGCA
  - 1.6 16v EcoBoost Belt: JQDA, JQDB, JQMA, JTBA, JTDA, JTDB, JTWA, JTWB, MUDA
  - 1.6D TDCi Belt: G8DA, G8DB, G8DD, GPDA, HHDA, HHDB, HHJA, HHJB, HHJC, HHJD, HHJE, HHJF, TZJA, TZJB
  - 1.6D TDCi EOnetic Belt: HHJD, G8DD, GPDA
  - 1.8 16v Belt: EYDB, EYDC, EYDD, EYDE, EYDF, EYDG, EYDI, EYDJ, EYPA, EYPC, RKA, RKB, RKC, RKF, RKH, RKJ, RKK, EYDL
  - 1.8 16v Chain: CDBB, CGBA, CGBB, CHBA, CHBB, CSDA, CSDB, Q7DA, QQDA, QQDB, QQDC
  - 1.8D TDCi Belt: BHPA, F9DA, F9DB, FFBA, FFDA, FFWA, HCPA, HCPB, KHBA, KKDA, KKDB, P7PA, P9PA, P9PB, QYBA, QYWA, R2PA, R3PA, RWPA, RWPC, TYWA
  - 1.8D TDdi Belt: BHDA, BHDB, C9DA, C9DB, C9DC, BHPA
  - 1.8D TCI Belt: RFN
  - 1.8D Turbo Belt: C9DC, RTN, RTQ, RTP
  - 2.0 16v Belt: ALDA, EDDB, EDBB, EDBC, EDBD, EDDA, EDDC, EDDD, EDDF, HMDA, NGA, NGB, NGC, NGD, YF
  - 2.0 16v Chain: AOBA, AOBC, AODA, AODB, AODE, AOWA, AOWB, CJBA, CJBB, N4JB, SYDA, TBBA, TBBB, TBWA, TBWB
  - 2.0D TDCi Belt: AZBA, AZBC, AZWA, AZWC, G6DA, G6DB, G6DC, G6DD, G6DE, G6DF, G6DG, IXDA, KLBA, LPBA, QXBA, QXBB, QXWA, QXWB, TXBA, TXDA, TXDB, TXWA, TYBA, TYDA, TYWA, UFBA, UFDA, UFDB, UFWA, UKBA, UKDA, UKDB, UKWA
  - 2.2D TDCi Belt: KNBA, Q4BA
  - 2.3 16v Chain: GZFA, GZFB, GZFC, SEBA, SEWA, GZ
- OEM Ref:
- 303-732 (21-260) • 303-620 (21-163) • 303-507 (21-210)
  - 303-193 (21-104) • 303-393A (21-168) • 303-393A (21-168)
  - 303-393-02 • 303-393-01 • 303-651 (21-229) • 303-376 (21-162B)
  - 303-734 (21-262) • 303-1054 • 303-748 • 303-1097 • 303-1059 • 303-735 (21-263)

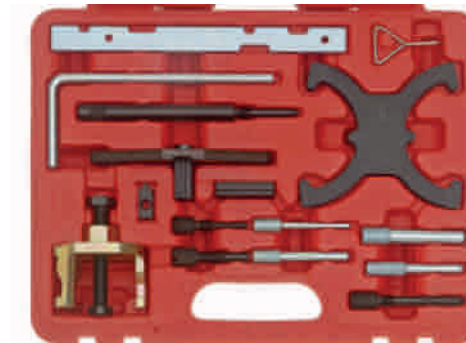

## FranklinFord 1.4TDCI, 1.6TDCI / ECO Diesel TA433

Applications:  
Fiesta V, Fiesta VI, Focus, Focus C Max (Grand), Galaxy, Mondeo, S Max

Engine Codes:  
• 1.4TDCI: F6JA, F6JB, F6JC, F6JD  
• 1.6TDCI: G8DA, G8DB, G8DD, G8DE, G8DF, GPDA, GPDC, HHDA, HHDB, HHJA, HHJB, HHJC, HHJD, HHJE, HHJF, MTD, TZJA, TZJB, T1BA, T1BB, T1BC, T1DA, T1DB, T3DA, T3DB, UBJA

OEM Ref:  
21-260 • 303-732 • 21-262 • 303-734 • 21-263 • 303-735



## Franklin Ford 2.0D, 2.2D, TDCi AT4320

Applications:  
C-MAX, Grand C-MAX, Focus, Focus C-MAX, Galaxy, Kuga, Mondeo, S-MAX

Engine Codes:  
• 2.0 TDCI: AZBA, AZWA, G6DA, G6DB, G6DC, G6DD, G6DE, G6DF, G6DG, IXDA, KLBA, KNBA, LPBA, Q4BA, QXBA, QXBB, QXWA, QXWB, TXBA, TXDA, TXDB, TXWA, TYBA, TYDA, TYWA, UFBA, UFDA, UFDB, UFWA, UKBA, UKDA, UKDB, UKWA  
• 2.2 TDCI: KNBA, Q4BA

OEM Ref:  
303-393/303-393A • 303-393-01 • 303-735 • 303 1059



## Franklin Ford 1.25, 1.4, 1.6, 1.7, 1.8 & 2.0 2.3 Petrol TA4301

Applications:  
Ford: Fiesta/Courier, Fusion, Puma, Focus/C-Max, Mondeo, Cougar, S-Max, Galaxy, Tourneo Connect, Transit Connect

Engine Codes:  
• 1.25: DHA DHB DHC DHD DHE DHF DHG F8JA F8JB FUJA FUJB M7JA M7JB SNJA SNJB STJA STJB  
• 1.4: FHA FHD FHE FHF ASDA ASDB FXDA FXDB FXDC FXDD FXJA FXJB FXJC RTJA RTJB SPJA SPJC UTJA  
• 1.6: L1F L1J L1L L1N L1Q L1T L1 FYDA FYDB FYDC FYDD FYDH FYJA FYJB FYJC HWDA HWDB  
• 1.7: MHA MHB  
• 1.8: RKA RKB RKF RKH RKJ RKK CCBB CGBA CGBB CHBA CHBB CSDA CSDB EYDB EYDC EYDD EYDE EYDF EYDG EYDI EYDJ EYPA EYPC QQDA QQDB QQDC  
• 2.0: NGB NGC NGD N4JB AODA ADOB AOWA CJBA CJBB EDDB EYDB EYDC EYDD EYDE EYDF EYDG EYDI EYDJ EYPA EYPC QQDA QQDB QQDC  
• 2.0 16v Chain: AOBA, AOBC, AODA, AODB, AODE, AOWA, AOWB, CJBA, CJBB, N4JB, SYDA, TBBA, TBBB, TBWA, TBWB  
• 2.3 16v Chain: GZ, GZFA, GZFB, GZFC, SEBA, SEWA

OEM Ref:  
• 21-163/303-620 • 21-210/303-507  
• 21-162B/303-376/303-376B • 21-159/303-748



## Franklin Ford 2.2 TDCi Transit Diesel Timing Set AT4322

Applications:  
Transit

Engine Codes:  
• 2.2 TDCi: CYFA, CYFB, DRFA, DRFB, P8FA, P8FB, PGFA, PGFB, QVFA, QWFA 2006, SRFA, SRFB, SRFC, SRFD, SRFE, UHFA  
• 2.2 TDCi ECONetic: CYFC, DRFC  
• 2.2 TDCi HDT: USRA

OEM Ref:  
303-698/21-251 • 303-1587



## Franklin Ford Duratorq 2.0D, 2.2D, 2.4D Diesel Timing Set AT4324

Applications:  
Mondeo, Transit

Engine Codes:  
• 2.0D TDCI: FIFA, FMBA, FMBB, HJBA, HJBB, HJBC, HJBE, N7BA, N7BB  
• 2.0D TDDi: D5BA, D6BA  
• 2.0D Di: ABFA, D3FA, F3FA  
• 2.2D TDCi: BG, CYFA, CYFB, DRFA, DRFB, P8FA, P8FB, PGFA, PGFB, QJBA, QJBB, QJBC, QJBD, QVFA, QWFA, SRFA, SRFB, SRFC, SRFD, SRFE, UHFA  
• 2.2D TDCi ECONetic: CYFC, DRFC  
• 2.4D Di: DOFA, D2FA, D2FB, D4FA, F4FA, FXFA  
• 2.4D 2.4D TDCi: H9FA, H9FB, H9FD, JXFA, JXFC, PHFA, PHFC

OEM Ref:  
303-679A (21-238) • 303-1151 • 303-1151 • 303-698 (21-251) • 303-675 (21-234)



## Franklin Jaguar 2.7TDV6 Diesel AT4910

Applications:  
S-Type, XF, X, XJ6

Engine Codes:  
• 3.0D SDV6/TDV6: 306DT, AJ-V6D

OEM Ref:  
303-1117 • 303-1116 • 303-1132 • 303-1126



**Franklin Jaguar Duratorq Bosch Pump Set TD / TDCi**

**AT4324**

Applications:  
X Type  
Engine Codes:  
• 2.0D: FMBA, FMBB • 2.2D: BG, QJBA  
OEM Ref:  
303-1151 • 21-238 • 303-69



Chain



**Franklin Land Rover Td4 Diesel Timing Set**

**AT4320**

Applications:  
Freelander 2 Td4, Range Rover Evoque  
Engine Codes:  
• DW12CTED4 • DW12BTED/224DT  
OEM Ref:  
• 303-1277 • 303-1270



Belt



**Franklin Land Rover Duratorq 2.4D Diesel**

**AT4324**

Applications:  
Defender  
Engine Codes:  
• 2.4D TD4: 244DT  
OEM Ref:  
303-1151 • 21-238 • 303-698



Chain



**Franklin Land Rover Freelander II Petrol Timing Set**

**AT4530**

Applications:  
Freelander II  
Engine Codes:  
• 3.2i6: DW12CTED4/22DT  
OEM Ref:  
303-1226 • 303-1225 • 303-1219 • 303-1223



Chain



**Franklin Land Rover 2.7TDV6, 3.0D Diesel**

**AT4910**

Applications:  
Discovery 3, Discovery 4, Range Rover Sport  
Engine Codes:  
• 2.7D/TDV6/TDVI: 276DT • 3.0D TDV6: 306DT  
OEM Ref:  
303-1117 • 303-1116 • 303-1132 • 303-1126



Belt



**Franklin Land Rover 2.0D, 3.0D Diesel**

**TA416**

Applications:  
Freelander, Range Rover  
Engine Codes:  
• 2.0D: 204D3/TD4 • 3.0D: TD6  
OEM Ref:  
• LRT 12-108 • 303-912 • LRT 12-173 • 303-971 • LRT 12-174  
• 303-972 • LRT 12-172 • 303-970 • LRT 12-227 • 303-1016 • 11 6 080



Chain





**Franklin Land Rover 2.4D TD4 Diesel**  
**TA433**

Applications:  
Defender  
Engine Codes:  
• 2.4D TD4 : 244DT  
OEM Ref:  
• 21-234 / 251 • 21-251 • 303-698 • 0194B  
• 21-263 • 303-735 • 0194C • 21-262 • 303-734



**Franklin Mini 1.6, 2.0 Diesel**  
**AT4119**

Applications:  
Clubman, Clubvan, Countryman, Mini, Paceman, Roadster  
Engine Codes:  
• 1.6D: N47 C16K1, N47 C16U1 • 2.0D: N47 C20K1, N47 C20U1  
OEM Ref:  
115 320 • 118 760 • 116 480 • 118 740 • 113 340

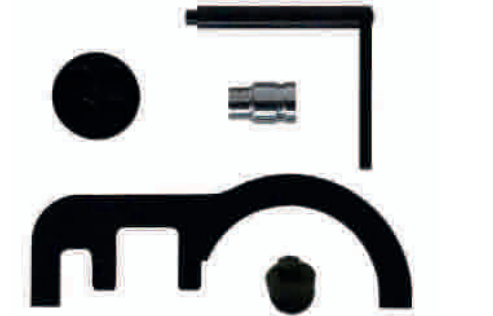

**Franklin Land Rover 2.5 TD5 Diesel Timing Set**  
**TA493**

Applications:  
Defender, Discovery II  
Engine Codes:  
• 2.5D TD5: 10P, 15P  
OEM Ref:  
LRT-12-158 • LRT-12-058



**Franklin Mini 1.6 N13 & N18 Petrol**  
**AT4124**

Applications:  
Cooper S [R56/57], Coupe Cooper S [R58, Countryman [R60],  
Paceman [R61]  
Engine Codes:  
• N13 B16A • N18 B16/M0 • N18 B16A/M0  
OEM Ref:  
11 7 440 • 11 9 340 • 496 709 • 11 9 590



**Franklin Mazda 1.25, 1.4, 1.6, 1.8, 2.0, 2.3, 2.5 Petrol**  
**TA4301**

Applications:  
2, 3, 5, 6, 121, MPV, MX5, Tribute  
Engine Codes:  
• 1.25 (Belt): DHA, FUJA, FUJB, F8JA, F8JB  
• 1.4 (Belt): FXJA, FXJB  
• 1.6 (Belt): FYJA  
• 1.8 (Chain): L8, MRZ (Auto)  
• 2.0 (Belt / Chain): LF, YF, MRZ (Auto)  
• 2.3 (Chain): L3  
• 2.5 (Chain): L5  
OEM Ref:  
49JE01061 • 303-748 • 49N101101 • 49JE0154



**Franklin Mini 1.4, 1.6, N12, N14 Petrol**  
**AT4411**

Applications:  
One R56, Cooper (R55, R56), Cooper S (R55, R56)  
Engine Codes:  
• 1.4: N12B14/A  
• 1.6: N14 B16A, N14 B16CD  
• 1.6: N12B16A, N16 B16A, N16 B16KO, N16 B16MO, N16B16UO  
OEM Ref:  
Screws • 119-340 • 119 590 • 119 552 • 119 540 • 119 550 • 119 540



**Franklin Nissan 1.5, 1.9, 2.2, 2.5 Diesel**  
**AT4256**

Applications:  
Micra, Almera, Note, Qashqai, Kubistar

Engine Codes:  
• 1.5 DCI K9K: 260/270/272/274/276/702/704/710  
• 1.9D DCI: F9Q/F9Q 760/762/772/774  
• 2.2D DCI: G9T 722/750  
• 2.5D DCI: G9U 630/632/650/720/724/726/730/750/754

OEM Ref:  
• MOT 1536 • KM-6203 • MOT 1537 • KM-6204  
• MOT 1534 • KM-6205 • MOT 1538 • MOT 1489  
• MOT 1054 • MOT 1430 • MOT 1543



**Franklin Nissan 1.6, 2.0 Petrol Engine**  
**TA422**

Applications:  
Kubistar, Primastar

Engine Codes:  
• 1.6: K4M 752/753  
• 2.0: F4R720/722/800

OEM Ref:  
MOT 1489 • MOT 1054 • MOT 1496



**Franklin Peugeot 1.0 VTi/1.2 VTi Petrol**  
**AT4408**

Applications:  
208, 2008, 308

Engine Codes:  
• 1.0VTi: EBO (ZMZ), ZMZ (EBO)  
• 1.2 VTi: HMZ (EB2), HMY (EB2M), EB2 (HMZ)  
• 1.2 E-VTi: EB2F (HMZ), EB2 (HMZ)

OEM Ref:  
0109-2B • 0109-2A



**Franklin Peugeot TU3/ET3 1.4 8v/16v Petrol**  
**AT4409**

Applications:  
1007, 206, 206+, 207, 307, Bipper, Partner

Engine Codes:  
• ET3J4 (KFU)  
• TU3A/JP/L3/L4 (KFT, KFV, KFW, KFX)

OEM Ref:  
• 4533-T.AC1 • 0132-AJ1 • 0189-B • 0187-B • 0188-M  
• 0194-B • 0132-RZ • 4507-TB • 4507-TA • 0132-QY  
• 4200-TH • 0153-AL • 4533-TAD • 0132-AK • 0188-K  
• 0153-AK • 0189-K • 0153-AE • 0178-D • 0194-A  
• 0132-AB • 4527-TS2 • 5711-TD



**Franklin Peugeot 1.4, 1.6, EP3, EP6 Petrol**  
**AT4411**

Applications:  
207/CC, 208, 308/CC, 508, 3008, 5008, Partner, RCZ

Engine Codes:  
• 1.4VTi: EP3/C 8FP, 8FR, 8FS  
• 1.6VTi: EP6/C 5FK, 5FS, 5FW  
• 1.6: GT/THP EP6CDTE/X/DT 5FN, 5FR, 5FT, 5FU, 5FV, 5FX, 5FY

OEM Ref:  
Screws • 119-340 • 0197-B • 119-552 • 0197-A3 • 0197-A2 • 0197-A1



**Franklin Peugeot 2.7HDI Diesel**  
**AT4910**

Applications:  
407, 607

Engine Codes:  
• 2.7D HDi: DT17BTED4 (UHZ)  
• 3.0D HDi: D20CTED4 (X8Z)

OEM Ref:  
0195-H • 0195-C • 0195-K • 0188-K



## Franklin Peugeot Flywheel Locking Tool TA445

Applications:  
Used to prevent the crankshaft from turning whilst removing the crank pulley retaining bolt.

- Engine Codes:
- 205 305 306 309 (1.6 1.9 1.8D/TD 1.9D/TD)
  - 405 (1.6 1.9 1.8 2.0 1.8TD 1.9D)
  - 406 605 806 Boxer Expert J5 Express Partner (1.9D/TD)
  - 605 Boxer
- OEM Ref:  
0153A • 6012T • D86



## Franklin Peugeot DW8 DW10 DW12 Hdi Diesel TA541

- Applications:
- 1.9 : 206, 306, Expert, Partner
  - 2.0 : Expert, Boxer, 206, 306, 307, 406, 407, 308, 607, 806, 807, 508, 3008, 5008, RCZ
  - 2.2 : 406, 407, 508, 607, 807, 4007, Boxer

- Engine Codes:
- 1.9 : DW8 (WJZ)
  - 2.0 : DW10ATED4, DW10JATED4, DW10BTED/L3, DW10ATD, DW10TD, DW10ATED, D10BTED, DW10UTD, DW10TD, DW10CTED 4 RHA, RHE, RHF, RHG, RHH, RHJ, RHK, RHM, RHR, RHS, RHT, RHV, RHW, RHX, RHY, RHZ
  - 2.2 : DW12MTED4, DW12BTED4, D12TED4/L4, DW12UTED, DW12ATEDL, L4, DW12CTED4, 4HK, 4HL, 4HN, 4HP, 4HR, 4HS, 4HT, 4HW, 4HX, 4HY, 4HZ
- OEM Ref: 0188Y • 0188M • 0188X • 0188K • 0188F • 0188J2 • 0188P



## Franklin Renault 16v Petrol Timing Set AT4224

- Applications:  
Clio, Megane, Scenic, Laguna, Modus, Kangoo,  
Also used in Nissan Kubister X76
- Engine Codes:  
Camshaft Setting Bar and Crankshaft Timing Pins for Renault twin cam 16v engines : K4J K4M F4P F4R 1.4 / 1.6 / 1.8 / 2.0 16v (1998-)
- OEM Ref:  
MOT 1489 • MOT 1054 • MOT 861 • MOT 1496 • MOT 1750 • MOT 1490-01



## Franklin Renault 1.5, 1.9, 2.2, 2.5 Diesel AT4256

- Applications:  
Be-Bop, Captur, Clio, Espace, Fluence, Kangoo, Laguna (1, 2), Master, Megane (II), Modus, Scenic (II), Traffic II, Vel sasis
- Engine Codes:
- 1.5 DCI K9K: 700/702/704/706/708/710/712/714/716/718/722/724 728/7 29/732/750/752/760/764/766/768/790/792
  - 1.9 DCI: F9Q 650/660/664/670/674/680/690/718/732/733/740/748/750 751/752/754/755/759/760/762/772/774/790/800/803/804/808 812/814/818/ 820/826
  - 2.2 DCI: G9T 600/605/606/607/642/643/645/700/702/703/706/707/710 720/722/742/743/750
  - 2.5 DCI: G9U 630/632/650/720/724/726/730/750/754
- OEM Ref:  
• MOT 1536 • KM-6203 • MOT 1537 • KM-6204 • MOT 1534 • KM-6205  
• MOT 1538 • MOT 1489 • MOT 1054 • MOT 1430 • MOT 1543



## Franklin Renault 1.8, 2.0 Cam Sprocket Tool AT428

- Applications:  
Renault: Clio II, Clio III/Sport, Espace/Grand Espace, Espace/Grand Espace IV, Laguna, Laguna II, Laguna III, Megane), Megane II, Megane III/Sport, Megane/Scenic, Scenic/RX4, Scenic/Grand Scenic II, Traffic II
- Nissan: Primastar X83
  - Vauxhall/Opel: Vivaro
- Engine Codes:
- F4P 1.8 16v: 720, 722, 760, 770, 771, 722, 773, 774, 775
  - F4R 2.0 16v: 700, 701, 712, 713, 714, 715, 720, 722, 730, 732, 740, 741, 744, 746, 762, 763, 764, 765, 766, 767, 770, 771, 774, 776, 780, 784, 786, 787, 790, 791, 792, 794, 795, 796, 797, 800, 802, 810, 811, 820, 830, 832, 867, 870, 874, 886, 887, 896, 897
- OEM Ref: MOT 1509 • MOT 1801



## Franklin Renault 2.0 16v IDE Timing Set TA427

- Applications:  
Megane, Laguna II, Laguna 2.0 IDE
- Engine Codes:  
F5R 700, 701, 740
- OEM Ref:  
MOT 1054 • MOT 1526





## Franklin Renault Twin Cam 16v Petrol TA422

Applications:  
Avantime, Clio (2, 3), Espace, Espace 1V, Kangoo (II), Laguna (1, 2, 3), Logan, Megane (II, III), Modus (Grand), Scenic (II, III), Traffic II, Twingo II, Vel Satis

Engine Codes:  
• 1.4 16v K4J: 700/710/711/712/713/714/715/730/732/740/750/770/780  
• 1.6 16v/GT: K4M 690/700/701/704/706/708/709/710/711/712/714/716  
718/720/724/730/732/734/740/742/743/744/745/746/748  
750/752/753/760/761/764/766/782/790/791 1792/794/800  
801/802/804/812/813/ 824/830/831/834/846/848/854/858  
862/866  
• 1.8 16v: F4P 720/722/760/770/771/772/773/774/775/780  
• 2.0 16v/T: F4R 700/701/712/713/714/715/720/721/722/730/732/770  
771/790/791/792 1820/830/832+ F4RT 740/741/746/762/763  
764/765/767/774/776/784/786/787/794/795/796/797/800  
802/810/811/867/874/886/887/896/897

OEM Ref:  
MOT 1489 • MOT 1054 • MOT 1496



## Franklin Saab 1.9D TID, TTID Diesel Timing Set TA559

Applications:  
9-3, 9-5

Engine Codes:  
• 1.9D TID: Z19DT, Z19DTH • 1.9 TTID: Z19DTR

OEM Ref:  
32 025 008 • 32 025 009 • 87 92 335 • EN46789-100



## Franklin Suzuki 1.0, 1.2 Petrol TA551

Applications:  
Wagon

Engine Codes:  
• 1.0: Z10XEP  
• 1.2: Z12XEP

OEM Ref:  
09912-38310 • 09919-58310 • 09919-58320 • 09919-08310

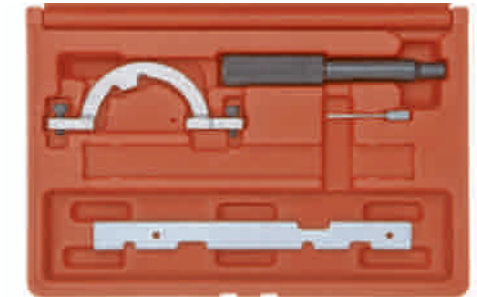

## Franklin Suzuki 1.3D DDIS Diesel TA553

Applications:  
Ignis, Splash, Swift, Wagon R

Engine Codes:  
• 1.3: Z13DT, D13A, Z13DTJ

OEM Ref:  
09917-68610 • 09912-38300 • KM6130



## Franklin VAG 1.0 Petrol Timing Set AT4413

Applications:  
• Seat: Mii  
• Skoda: Citigo, Fabia  
• Volkswagen: Up, Polo

Engine Codes:  
• 1.0: CHYA, CHYB, CPGA

OEM Ref:  
T10340 • T10477 • T10499 • T10476 • T10500

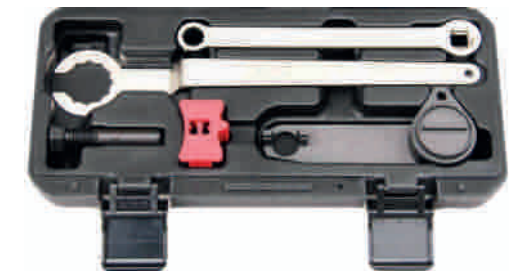

## Franklin VAG 1.2 6V, 12V - 3 Cyl Petrol Timing Set

**TA548**

Applications:

- Seat: Cordoba, Ibiza
- Skoda: Fabia 2, Roomster
- Volkswagen: Fox, Polo 1V, Polo V

Engine Codes:

- 1.2: AWY, AZQ, BBM, BMD, BME, BXV, BZG, CEVA, CGPA, CGPB, CHFA,

OEM Ref:

T10123 • T10120 • T10121

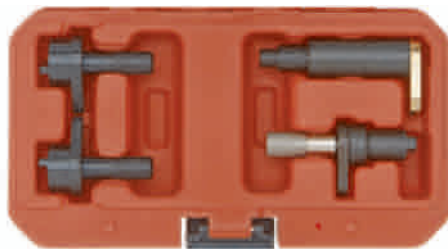

## Franklin VAG 1.2, 1.4 TFSi, 1.4, 1.6FSi Petrol Timing Set

**AT4415**

Applications:

- Audi: A1, A3 • Seat: Altea / Altea XL, Ibiza / Cordoba, Leon, Toledo
- Skoda: Fabia II, Octavia II, Roomster, Superb II, Yeti
- VW: Caddy/Caddy Maxi, Eos, Golf, Golf Plus, Jetta, Passat, Polo, Scirocco, Tiguan, Touran

Engine Codes:

- 1.2TSi: CBZA, CBZB, CBZC
- 1.4FSi: AXU, BKG, BLN
- 1.4TFSi: BLG, BMY, BWK, CAVA, CAVB, CAVC, CAVD, CAVE, CAVF, CAXA, CAXC, CDGA, CSMA
- 1.6FSi: BAG, BLF, BLP, BTS

OEM Ref:

T10170. T10171 • T40011 • T10340 • T10414



## Franklin VAG 1.8/2.0 TFSi Petrol Timing Set

**AT4419**

Applications:

- Audi: A3, A4, A5, A6, Q3, Q5, TT
- Seat: Leon, Toledo, Altea, Altea XL, Exeo, Alhambra
- Skoda: Yeti, Octavia II, Octavia III, Superb
- Volkswagen: Golf, Beetle, Jetta, Scirocco, Eos, Passat, Passat CC, Tiguan, Sharan, Amorok

Engine Codes:

- 1.8 TFSi: BYT, CDAA, CJSB, BZB, CDAB, CJSB, CABA, CDHA, CABB, CDHB, CABD, CJEB
- 2.0 TFSi: CAWA, CCZB, CDND, CHHA, CPLA, CAWB, CCZC, CESA, CHHB, CPSA, CBFA, CCZD, CETA, CJKA, CCTA, CDNB, CFKA, CJKB, CCZA, CDNC, CFPA, CNCD

OEM Ref:

T10368 • T10352 / T10352/1 / T10352/2 • T40011

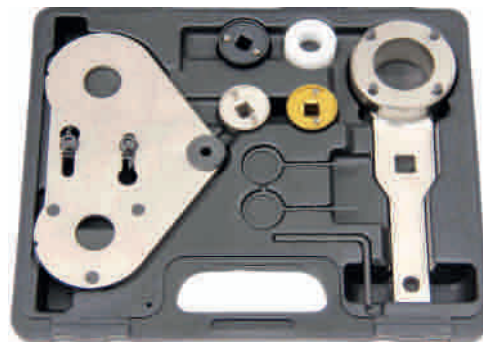

## Franklin VAG 1.8/2.0 4v TFSi Petrol Timing Set

**AT4417**

Applications:

- Audi: A4 quattro, A5 Coupe/Cabriolet, A5 Sportback, A6, Q3, Q5, TT
- Seat: Alhambra, Altea/Altea XL, Exeo, Leon, Toledo
- Skoda: Octavia II, Superb II, Yeti
- Volkswagen: Beetle, Eos, Golf VI, Passat/CC/Alltrack, Sharan

Engine Codes:

- 1.8: CDAA, CDAB, CDHB, CGYA
- 2.0: CCZA, CCZB, CCZC, CCZD

OEM Ref:

• T10352 T10352/1 • T40271-1 • T40271-2 • T40265 • T40011  
• T40267 • T10170 • VAS6079

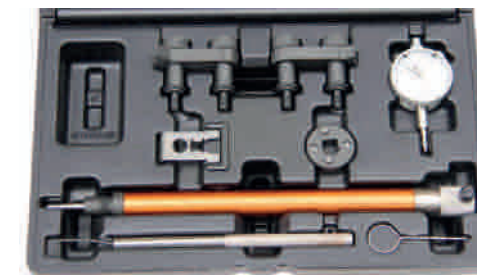

## Franklin VAG 1.6, 1.8T, 2.0 Petrol, 1.7D & 1.9D SDi/Tdi Diesel Timing Set

**AT4414**

Applications:

- Audi: 80, A3, A4, A6, S3, TT
- Seat: Alhambra, Altea/Altea XL, Arosa, Cordoba, Exeo, Ibiza, Inca, Leon, Toledo
- Skoda: Fabia, Felicia, Octavia/Octavia Tour, Octavia II, Superb
- Volkswagen: Beetle, Bora, Caddy/Pick-Up, Fox, Golf, Golf Plus, Jetta, Lupo, Passat, Polo, Sharan, Touran, Transporter, Vento

• Ford: Galaxy

Engine Codes:

Diesel:

- 1.7D: AHG
- 1.7D SDi: AHB, AKU, AKW 1.9 D: 1X, 1Y, ABL, AEF 1.9D Turbo: AAZ
- 1.9 SDi: AEY, AGD, AGP, AQM, ASX, ASY, AYQ
- 1.9 TDi: 1Z, AFF, AFN, AGR, AHF, AHH, AHU, ALE, ALH, ASV, AVG

Petrol:

- 1.6: 1F, ADP, AEH, AEK, AFT, AHL, AKL, AKS, ALZ, ANA, APF, ARM, AUR, AVU, AYD, BFQ, BFS, BGU, BSE, BSF, CCSA, CHGA, CMXA
- 1.8: ABS, ADL, ADZ
- 2.0: 2E, AAC, AAE, ABF, ABK, ACE, ADY, AEG, AGG, AKT, APK, AQY, ATM, ATU, AWF, AWG, AXA, AZG, AZH, AZJ, AZL, AZM, BBX, BEH, BSX

Petrol - Chain in Head

- 1.8: AGN, APG, ADR, AFY, APT, ARG, AVV, AJP
- 1.8T: AEB, AGU, AJH, AJL, AJQ, AMK, AMU, ANB, APP, APU, APX, APY, AQA, AQX, ARX, ARY, ARZ, AUM, AUQ, AVC, AWC, AWU, AYP, BAM, BFV, BVP, BVR

OEM Ref:

• U40021/2065A/U20006/MP 1-300 • T20038/MP-1-312/3418  
• T10098 • 2064/U20003 • 3359 • MP-1-302/V159/U30009  
• T10020/3387 • T10092 • T40011 • T20044/3366

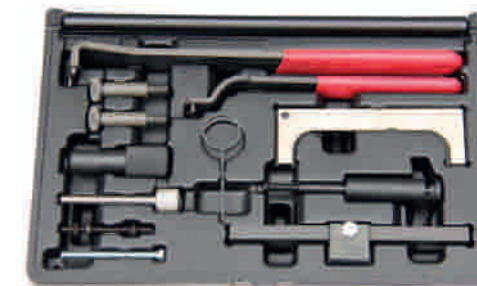

## Franklin VAG 1.2, 1.4, 1.9, 2.0 TDI PD Pompe Duse Timing Set

**AT4420**

Applications:

- Audi: A1, A2, A3, A4/Allroad, A5, A6/Allroad, TT, Q5
- Dodge: Caliber
- Ford: Galaxy
- Mitsubishi: Grandis, Lancer, Outlander
- Seat: Alhambra, Altea, Altea XL, Arosa, Cordoba, Ibiza, Leon, Toledo
- Skoda: Fabia, Fabia II, Octavia, Octavia II, Roomster, Superb, Superb II, Yeti
- Volkswagen: Amarok, Beetle, Bora, Caddy/Maxi, Eos, Fox, Golf, Golf Plus, Jetta, Lupo, Passat/CC, Polo, Scirocco, Sharan, Tiguan, Touran, Transporter

Engine Codes:

- Pompe Duse:
- 1.2D TDiPD: ANY, AYZ
- 1.4D TDiPD: AMF, ATL, BAY, BHC, BMS, BNM, BNV, BWB
- 1.9D TDiPD: AJM, ANU, ARL, ARX, ASZ, ATD, ATJ, AUY, AVB, AVF, AVQ, AWX, AXB, AXC, AXR, BJB, BKC, BKE, BLS, BLT, BMT, BPX, BPZ, BRB, BRM, BRR, BRS, BRU, BSU, BSV, BSW, BTB, BUK, BVK, BXE, BXF, BXJ
- 2.0D TDiPD: AZV, BEW, BKD, BDJ, BDK, BGW, BHW, BKP, BLB, BMA, BMM, BMN, BMP, BMR, BNA, BPW, BRC, BRD, BRE, BRF, BRT, BSS, BST, BSY, BUY, BUZ, BVA, BVE, BVF, BVG, BVH, BWC, BWV

• Common Rail

- 1.2D TDiCR: CFWA
- 1.6D TDiCR: CAYA, CAYB, CAYC, CAYD, CAYE, CLNA
- 2.0D TDiCR: CAAA, CAAB, CAAC, CAAE, CAGA, CAGB, CAGC, CAHA, CAHB, CBAA, CBAB, CBAC, CBBA, CBBB, CBDA, CBDB, CBDC, CBEA, CCHA, CCHB, CDBA, CDCA, CEGA, CFCA, CFFA, CFFB, CFGB, CFHA, CFHB, CFHC, CFHE, CFHF, CFJA, CGLA, CGLB, CJAA, CJCA, CJCB, CLCA, CLCB, CLJA, CMEA, ECD (Dodge)

OEM Ref:

- T10100 • T10050 • 3359 • T20102 • 3387 • U30009A • T10020
- T10264 • T10265 • T10115 • T10008 • T10060A • T40098 • T20167



## Franklin VAG 2.7/3.0 TDi V6 & 4.0/4.2 TDi V8 Diesel

**AT4427**

Applications:

- Audi: A4 (Allroad, Quattro), A5, A6 (Allroad, Quattro), A8, Q5, Q7
- Volkswagen: Phaeton, Touareg

Engine Codes:

- 2.7 TDI: BPP, BSG, CAMA, CAMB, CANA, CANB, CANS, CAND, CGKA, CGKB
- 3.0 TDI: ASB, BKN, BKM, BNG, BUG, BUN, CAPA, CARA, CASA, CASB, CASC, CASD, CATA, CCLA, CCWA, CCWB, CDYA, CDYB, CDYC, CEXA
- 4.0 TDI: ASE
- 4.2 TDI: BTR, BVN, CKDA
- V6: ASB, BKN, BKS, BMK, BMZ, BNG, BPP, BSG, BUG, BUN, CAMA, CAMB, CANA, CANB, CANS, CAND, CAPA, CARA, CARB, CASA, CASB, CASC, CATA, CCMA, CCWA, CCWB, CDYA, CDYB, CDYC, CEXA, CGKA, CGKB
- V8: ASE, BTR, BVN, CCFA

OEM Ref:

- 3242 • 3359 • T40049 • T40058 • T40060 • T4006 • T40062 • 3.3mm Pins



## Franklin VAG 1.6, 2.0 Common Rail Diesel Timing Set

**AT4418**

Applications:

- Audi: A1, A3, A4, A5, A6, Q3, Q5, TT
- Seat: Alhambra, Altea, Exeo, Ibiza, Leon, Toledo
- Skoda: Fabia 2, Octavia, Rapid, Roomster, Superb, Yeti
- Volkswagen: Amarok, Caddy Maxi, Crafter, Eos, Golf VI, Golf Plus, Jetta, Passat, Passat CC, Polo, Scirocco, Sharan, Tiguan, Touran, Transporter T5

Engine Codes:

- 1.6D TDI CR: CAYA, CAYB, CAYC, CAYD, CAYE, CLNA
- 2.0D TDI CR: CAGA, CAGB, CAGC, CAHA, CAHB, CAAA, CAAB, CAAC, CBAA, CBAB, CBAC, CBBA, CBBB, CBDA, CBDB, CBDC, CCHA, CDBA, CDCA, CEGA, CFCA, CFFA, CFFB, CFFD, CFFE, CFGB, CFHB, CFHD, CFGB, CFGC, CFGD, CGLA, CGLB, CGLC, CGLD, CFHC, CFHE, CFHF, CFJA, CJAA, CJCA, CJCB, CJCC, CKTB, CKTC, CKUB, CKUC, CLCA, CLJA, CLLA, CMEA, CMFA

OEM Ref:

- T20102 • 3359 • T10100 • T10050 • T10264
- T10265 • T10060A • T10051 • T10052 • T10255





## Franklin VAG 1.2, 1.4, 1.9 2.0 TDI PD Diesel Timing Set

**AT4416**

Applications:

- Audi: A2, A3, A4 (Quattro), A6 (Quattro)
- Seat: Alhambra, Altea, Arosa, Cordoba, Ibiza, Leon, Toledo
- Skoda: Fabia 2, Roomster, Octavia, Superb 2
- Volkswagen: Beetle, Bora, Caddy Maxi, Eos, Fox, Golf IV, Golf V, Jetta, Lupo, Passat, Polo III, Polo IV, Sharan, Touran, Transporter T5

Engine Codes:

- 1.2TDI PD: ANY, AYZ
- 1.4TDI PD: AMF, ATL, BAY, BHC, BNM, BNV, BMS, BWB
- 1.9TDI PD: AJM, ANU, ARL, ASZ, ATD, ATJ, AUY, AVB, AVF, AVQ, AWX, AXB, AXC, AXR, BJB, BKC, BKE, BLS, BLT, BPX, BPZ, BSV, BMT, BRM, BRR, BRS, BRU, BSU, BSW, BTB, BUK, BVK, BVH, BVK, BXE, BXF, BXJ
- 2.0TDI PD: AZV, BKD, BLB, BNA, BPW, BRC, BRD, BRE, BRF, BUY, BVA, BVF, BVG, BGW, BHW, BKD, BKP, BMA, BMM, BMN, BMP, BSS, BMR, BRT, BVH, BUZ, BVE, BWV
- 2.0SDI - BDJ, BDK, BST
- 2.0D TDiCR/TDi PD: CDCA, CEGA, CFCA, CFFA, CFFB, CFFD, CFFE, CFGB, CFHA, CFHB, CFHC, CFND, CFHE, CFHF, CFJA, CGLA, CGLB, CGLC, CGLD, CJAA, CJCA, CJCB, CJCC, CLCA, CLCB, CLJA, CLLA, CNEA, ECD

OEM Ref:

T20102 • 3359 • T10115 • T10050 • T10100 • T10008 • T10060A • T20167



## Franklin VAG 2.4, 2.5 Diesel Timing Set

**AT4443**

Applications:

Crafter, LT, Transporter T4

Engine Codes:

- 2.4D: AAB, AJA
- 2.5D SDi: AGX
- 2.5D TDi: ACV, AHD, AHY, AJT, ANJ, APA, AUF, AVR, AXG, AXL, AYC, AYY, BBE, BBF
- 2.5TDiCR: BJJ, BJK, BJL, BJM
- 2.5D Blue TDiCR: CEBA, CEBB, CECA, CECB

OEM Ref:

2064 • 2065A • T10025 • Shim Set • T10025 • T50009 • 3355



## Franklin VAG 2.5 TDi PD Diesel Timing Set

**AT4445**

Applications:

Transporter, Multivan T5, Touareg

Engine Codes:

- 2.5 TDi PD: AXD, AXE, BAC, BLJ, BLK, BNZ, BPC, BPD, BPE

OEM Ref:

T10193 • T10199 • T10199/1 • T10225 • T10226 • T10234



## Franklin VAG 1.8/1.8T, 2.0FSi/TFSi Petrol Timing Set

**TA4413**

Applications:

- Audi: A3, A4, A6, S3, TT
- Seat: Alhambra, Altea/Altea XL, Cordoba, Exeo, Ibiza, Leon, Toledo
- Skoda: Octavia/Octavia Tour, Octavia II
- Volkswagen: Beetle, Bora, Eos, Golf, Golf Plus, Jetta, Passat, Scirocco, Sharan, Touran

Engine Codes:

- 1.8: ADR, AFY, AGN, APG, APT, ARG, AVV, AJP
- 1.8T: AEB, AGU, AJH, AJL, AJQ, AMK, AMU, ANB, APP, APU, APX, APY, AQA, AQX, ARX, ARY, ARZ, AUM, AUQ, AVC, AWC, AWU, AYP, BAM, BFV, BVP, BVR
- 2.0FSi: AXW, BHD, BLR, BLX, BLY, BMB, BVX, BVY, BVZ
- 2.0 TFSi/S/R/TSi: AXX, BPY, BWA, BGB, BPG, BPJ, BUL, BWE, BWT, BYK, BHZ, BZC, BWJ, BYD, CDLA, CDLB, CDLC, CDLD, CDLF, CDMA

OEM Ref:

T10020 • T40011 • T10252 • T10115 • 3366 • T10060/ T10060A • T10092



## Franklin VAG Adj Tensioner Wrench

**TA4431**

For VAG models where OEM tool T10020 is specified - Tensioner wrench with five adjustable positions for use on many VAG models where access is restricted. Please note that a 4 mm hexagon key is required to adjust the relative position of the wrench head.

OEM Ref: T10020



**Franklin Vauxhall 1.0, 1.2, 1.4 Petrol Timing Set**

**TA551**

Applications:  
Agila, Astra-G, Astra-H (TwinPort), Combo, Corsa B, Corsa C (TwinPort),  
Corsa D, Meriva, Tigra B

Engine Codes:  
• 1.0: X10XE 12v, Z10XE 12v, Z10XEP  
• 1.2: X12XE 12v, Z12XE 16v, Z12XEP 16v  
• 1.4: Z14XEP, Z14XEL

OEM Ref:  
KM-952 • KM-953 • KM-954 • KM-955

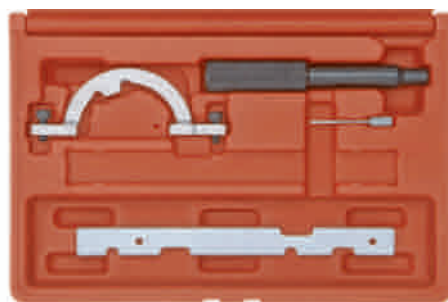

Chain



**Franklin Vauxhall 1.4, 1.6 16v Camshaft**

**TA471**

Applications:  
• Astra-G 1.4/1.6/1.8 16v  
• Corsa-C 1.4/1.8 16v  
• Vectra-B/C 1.4/1.6/1.8 16v  
• Zafira 1.6/1.8 16v

Engine Codes:  
X14XE, X16XEL X16SEJ, X18E1 Y16XE, Z14XE Z16XE, Z16YNG Z18XE,  
Z18XEL  
OEM Ref:  
KM852



Belt



**Franklin Vauxhall 1.3D CDTI Diesel**

**TA553**

Applications:  
Agila, Agila B, Astra H, Astra J, Combo, Corsa C,  
Corsa D, Meriva, Meriva B, Tiger B, Zafira B

Engine Codes:  
• 1.3D CDTI: A13DTC, A13DTE, A13DTR,  
D13A, Z13DT, Z13DTE, Z13DTH,  
Z13DTJ, Z13DTR

OEM Ref:  
EN 46781 • EN 46785 • KM 955



Chain



**Franklin Vauxhall 1.9, 2.2, 2.5 CDTI / DTI Diesel Timing Set**

**AT4256**

Applications:  
Movano, Vivaro

Engine Codes:  
• 1.9DI/DTI/CDTI: F9Q760/762/772/774  
• 2.2D DTI: G9T720/722/750  
• 2.5D DTI CDTI: G9U630/632/650/A720/724/726/730/750/754

OEM Ref:  
• MOT 1536 • KM-6203 • MOT 1537 • KM-6204 • MOT 1534  
• KM-6205 • MOT 1538 • MOT 1489 • MOT 1054 • MOT 1430 • KM-6234



Belt



**Franklin Vauxhall 1.6, 1.8 16v Twinport Petrol**

**AT4502**

Applications:  
Astra-G, Astra-H, Astra-J, Corsa-D, Insignia, Meriva-A,  
Signum, Vectra-C, Zafira-B, Zafira-C Tourer

Engine Codes:  
• 1.4 16V: G14D  
• 1.6: A16LEL, A16LER, A16LET, A16XER, LDE/A16LER,  
LDE/A16XER, LLU/A16LET, Z16LEL, Z16LER, Z16LET, Z16XE1,  
Z16XEP, Z16XER 192B3.000 (Z16XEP) • 1.6 ecoFLEX CNG: A16XNT,  
LGE/A16XNT, Z16XNT

• 1.8: 2HO/A18XEL, 2HO/A18XER, A18XER, Z18XER, 939A4.000

OEM Ref:  
• KM-6628-A • KM-6340 • KM-6333 • KM-6625  
• KM-6349 • KM-6130 • KM-911



Belt



**Franklin Vauxhall 1.2, 1.4 Twinport Petrol Timing Set**

**AT4504**

Applications:  
Adam, Agila, Astra-J, Combo, Corsa-D, Meriva-B, Mokka

Engine Codes:  
• 1.0: A10XEP  
• 1.2: A12XEL, L2Q/A12XEL, LWD/A12XEL  
• 1.2 Ecoflex: A12XER, A12XEL  
• 1.4: A14XEL, A14XEL, L2Z/A14XEL, LDD/A14XEL,  
LDD/A14XER, LDD/A14XEL, LUJ/A14NET  
• 1.4 Ecoflex: A14XER, LDD, LUH/A14NEL, LUJ/A14NET, LUU  
• 1.4 Turbo: LUJ/A14NEL, LUJ/A14NET

OEM Ref:  
• EN49977-100 EN49977-200 • KM-953-A • KM-952 • EN-499-78  
• EN-49977-200 • KM-955-1 • KM-955-2



Chain



**Franklin Vauxhall 2.0 Petrol**  
**TA422**

Applications:  
Vivaro  
Engine Codes:  
• 2.0: F4R720, F4R722, F4R820  
OEM Ref:  
MOT 1489 • MOT 1054 • KM-6031 • MOT 1496 • KM-6233



**Franklin Volvo 2.0D Timing Set**  
**AT4320**

Applications:  
C30, C70, S40, S80, V50, V70  
Engine Codes:  
D4204T, D4204T2  
OEM Ref:  
999-7119 • 999-7120 • 999-7121 • 999-7122



**Franklin Vauxhall 1.9, 2.0 DCDTI Diesel**  
**TA559**

Applications:  
Astra H, Astra J, Insignia, Signum, Vectra-C, Zafira B  
Engine Codes:  
• 1.9DCDTI: Z19DT, Z19DTH, Z19DTJ, Z19DTL  
• 2.0DCDTI: A20DT, A20DTC, A20DTH, A20DTJ, A20DTL  
OEM Ref:  
• 1.870.896.900 • EN-46789 • 1.860.905.000 • 1.860.905.010  
• 2.000.004.500 • 2.000.003.000 • EN-46788 • 1.860.965.010  
• KM-6349 • EN-46789-100



**Franklin Volvo 1.6, 1.8, 2.0 Petrol Timing Set**  
**TA4301**

Applications:  
C30, S40, S80, V50, V70  
Engine Codes:  
• 1.6: B4164S3 (Belt)  
• 1.8: B4184S8/11 (Chain)  
• 2.0: B4204S3/4 (Chain)  
OEM Ref:  
999-7152 • 999-7406 • 999-7201 • 999-7151



**Franklin Volvo 3.0 & 3.2 Petrol**  
**AT4530**

Applications:  
S80, XC60, XC70, XC90  
Engine Codes:  
• 3.0 Turbo: B6340T2, B6340T4  
• 3.2: B6324S, B6324S5  
OEM Ref:  
• 999-7264 • 999-7263 • 999-7272 • 999-7257  
• 999-7261 • 999-7266 • 999-7271



**Franklin 4 pce Cam Sprocket Tool Set**  
**A70905**

- Used on wide range of single double and quad overhead camshaft engines
- Retains engine timing whilst changing engine timing belts
- Easy to use - installs in seconds
- Suitable for engines with sprocket to cylinder head clearances 5mm to 25mm
- (35mm when the included bolt extensions are used)
- Patented 'Uni-Fit' positive lock tooth design securely engages all cam gear sizes

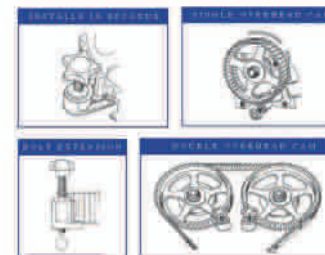



## Franklin Twin Camshaft Holding Tool

**TA76**

- For holding twin camshafts in place whilst changing timing belts
- For Rover 820 16v and similar applications

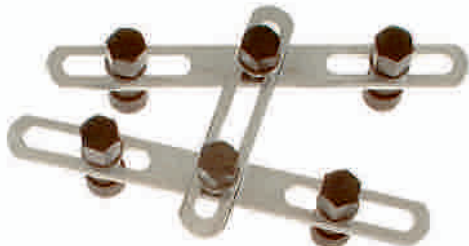

## Franklin Cam Sprocket Holding Wrench 420mm

**TA752**

- Allows pulleys to be rotated / aligned ready for engine timing work
- Also suitable for counter-holding pulleys when releasing or tightening retaining bolts
- Inter-changeable tips to suit a wide range of modern petrol & diesel engine timing pulleys with holes of at least 12mm dia.



## Franklin Belt Tensioner Plunger Pin Set

**TA401**

- Sizes :0.79 1.24 1.37 1.49 1.68 1.92 mm
- Used to keep the automatic tensioner plunger compressed whilst replacing the timing belt



## Artline Permanent Paint Marker

- Ideal for permanent indelible marking
- 2.3 mm Tip
- Instant Dry
- Bullet style

Part No.	Description
APMW	WHITE
APMR	RED
APMY	YELLOW
APMBE	BLUE
APMBK	BLACK



## Artline47 WETRITE Permanent Marker

Ideal for marking on non-porous wet surfaces - Metal, Plastic etc.

### Features

- Permanent and Waterproof
- Low Odour
- Acrylic Fibre Tip
- Instant Drying
- Bullet Style

Part No.	Description
AE47BU	BLUE
AE47R	RED
AE47BK	BLACK



	Page No.		Page No.
<b>A</b>		Bolt Extractor & Grips	B34 - B36, E17, J6, O3
Adjustable Wrenches	D5, F4	Box Spanner Set	D5
Air Blow Guns	L5, L6	Brake Bleed Tools	O14, P7, P8
Air Tools	L2 - L5	Brake Caliper Service Tools	P12 - P14
Airbag Removal Set	Q6	Brake Cylinder Hone	P11
Airline Equipment & Tools	L2 - L15	Brake Disc Pad Tools	P12 - P14
Airlines & Couplings	L6 - L14	Brake Fluid Tester	P7
Alloy Wheel Nut Set	B33, B34	Brake Pedal Holder	N5
Alternator Pulley Set	O8	Brake Pipe Flaring Tools	P8, P9
Angle Grinder	M6	Brushes Cup	I6, I8, I9, I10
Angle Wrenches	D9, D10, G9 - G12	Brushes Wire	I7, I8
Angular Torque Gauge	E26	Burrs Rotary	I6, I7
AntiFreeze Testers	N8	Bushing Drivers	P3
Aviation Tinsnips	I17, I18	Butane Gas Torch	J12
<b>B</b>		Butt End Circlip Pliers	H4
Ball End Hexagon Tools	B18, D9, D10, G10,	<b>C</b>	
Ball Joint Separators	P5	Cable Cutter	H13
Bearing Packer	P3	Camshaft Timing Tools	S2 - S37
Bearing Pullers	P3	Centre Punches	D6, D8, J6
Bearing Race Seal Driver	P3	Chain Wrenches	O9
Bearing Separator Sets	P2	Chisels & Punches	D6, D7, P8
Bench Grinder Brush	I9	Circlip Pliers	C14, C15, H3, H4
BiHex Sockets	B15, B16, B29, E5,	Circlip Tools	P11
Bit Holder Sockets	B49, E15	Circuit Testers	N4, N5
Bit Sockets	B9 - B11, B17 - B26,	Clamps	D14, H6, H7, H10,
Blind Bearing Pullers	P3	Club Hammers	J7
Blow Guns	L5, L6	Clutch Alignment Tools	P4
Blow Torch	J12	Cobalt Steel Drills	I2, I4
Body Panel Repair Tools	Q2, Q3	Coil Spring Compressor	P6
Body Tools	Q2 - Q5	Combination Bit Sets	E15, G8

	Page No.		Page No.		Page No.		Page No.
Combination Pliers	C11, H2, H14	Drain Pans	O15	Gauges Feeler	O4	Inspection Mirrors	D12, J4
Combination Spanners	C2 - C7	Drain Plug Keys and	B27, O13	Gloves Work	R2, R3	Insulated Screwdrivers	G5
Compression Testers	F2 - F4	Drill Drivers	M3 - M5	Goggles Safety	R4	Irwin	
Convertors	B37, B48, B49, E19	Drills Cobalt	I2, 14	Grease Guns and	O17	Bolt Grips & Extractors	E17
Cooling System Filler	O19	Drills High Speed	I2 - I5	Groove Joint Pliers	H14, H15	Hacksaws & Knives	I15, J11
Cooling System Tester	N8	Drills Spot Weld Removal	Q2	<b>H</b>		HSS Drills	I4
Copper Hammers	J8	Dust Mask	R4	Hacksaw Blades and Frames	I15 - I17	Impact Bits	G7, G9
Corrosion Assessment Tool	Q2	<b>E</b>		Hammers	J6 - J9	Knee Pads	R4
Coveralls	R5	Ear Defenders	R4	Hand Held Flaring Tools	D13, P8	Tape Measures	J11
Crimping Pliers	C18, H2	Electrician's Screwdrivers	G5	Headlamp Alignment Tool	Q2	Wrenches & Pliers	H4 - H16
Crowfoot Wrenches	C8, C9, E12	Engine Compression Testers	N6, N7	Hexagon & Torx Wrenches	D9, D10, G10 - G12	<b>J</b>	
Cup Filter Tools	O11, O12	Engine Cylinder Hone	O2	Hexagon Angle Wrenches	D9, D10, G10 - G12	Jab Saw	I15
Cutting Discs	I13	Engine Timing Tools	S2 - S37	Hexagon Bit Sockets	B9, B10, B16 - B19,	Jugs & Measures	O17
CV Boot Clamp Tools	P4	Exhaust Clamp Spreader VW	O21	Hexagon Bits	E15, G8	Junior Hacksaw	I15, I17
Cylinder Head Bolt Tools	O6, O7	Extension Bars	B48, B50 - B54, E9,	High Speed Drill Bits	I2 - I5	<b>K</b>	
Cylinder Hone	O2	External Star Sockets	B11, B12, E6, E12,	Hose / Soft Pipe Cutter	O21	Knives & Blades	J10, J11
<b>D</b>		<b>F</b>		Hose Clamp & Clip Pliers	D14, O19 - O21	<b>L</b>	
DeadBlow Hammers	J7	Feeler Gauges	O4	Hose Clamps	D14, P12	Lambda Oxy Sensor Socket	D15, O22
DeCoke Brush Set	I6	File Sets	D9, I18	HSS Drills	I2 - I5	LED Lights	K2 - K16
Depth Gauges	P14, P15	Filter Regulator Lubricator	L8, L9	Hub & Shaft Pullers	P6	Lighting Equipment	K2 - K16
Diamond Lacing Set	Q5	Flap Discs	I9, I13	Hub Nut Sockets	E4 - E8, E18, E19	Lock Grip Pliers	C10, C15 - C17, H4 -
Die Grinder	L2	Flare Nut Wrench	D4, P10	Hydraulic Puller	P2	Lock Nut Removal Tools	B36, D18, E18
Diesel Compression Sets	N7	Flaring Tool Set	P8, P9	<b>I</b>		Lock Out Tool Kit	Q4
Diesel Engine Timing Tools	S3 - S37	Flexible Dash Knife	Q5	Impact Bits	G6 - G9	Lubrication	O17
Diesel Injector Pullers	O5	Fluid Extractors	O14 - O17	Impact Driver and Bits	G6	<b>M</b>	
Diesel Injector Sockets	O6, O7	Fuel Coupling Pliers	N6	Impact Sockets	B33, B34, B38 - B40,	Magnetic Parts Dish	J5
Dipsticks Engine &	O15	Fuel Filter Cup Tools	O11, O12	Impact Wrenches	L2 - L4, M2, M5	Magnetic Pickup Tools	D12, J3
Door Trim Panel Tools	D16, Q2, Q3	Funnel with Filter	O18	Injector Pullers	O5	Magnetic Screwdriver	C19 - C26, D11
Dormer Spot Weld Drills	Q2	<b>G</b>		Inspection Lamps	K2 - K7	Magnetic Socket Trays	E21



	Page No.		Page No.		Page No.		Page No.
Magnetiser	G5	Poly Discs	I12, I13	Screwdriver Bit Sets	B26, C22 - C26, G7	Strap Wrenches	O9
Magnetiser Wera	G5	Power Bars	B48, E9	Screwdrivers	C19 - C26, D11, G2	Strut Nut Tool	P7
Mallets	J9	Power Bit Sets	G6 - G8	Screwdrivers Star	C21, C22, G3, G4	Stud Extractors	D18, O3
Measuring Equipment	D13, J11, J12	Powerprobe Products	N2, N3	Seal Driver	P3	Sump Plug Repair Kits	O13
Mechanic's Screwdrivers	C19 - C22, D11, G2	Precision Screwdrivers	C22, G5	Seat Covers	R5 - R8	Surge Protector	N5
Mini Pick and Hook Set	J4	Pry Bars	J2, J3	Security Bit Set	G7	Suspension Tools	P5, P6, P14
MoT Approved Tools	P14, Q2	Pullers	O5, P2, P3, P6, Q3	Side Cutters	C11, H2, H12, H15,	<b>T</b>	
Multi Drive Sockets	B8, B9, B16, B29, C23,	Pulley Holding Kit	S38	Sledge Hammers	J7	Tamperproof Star	B10, B22, B23, C22,
Multimeters	N4	Pulley Pullers	O8	Slide Hammers	P6	Tap & Die Set	I20
<b>N</b>		Punch & Chisel Set	D6 - D8	Socket Rails	E21	Tape Measures	D13, J11, J12
Needle File Set	I18	<b>Q</b>		Sockets & Accessories	B2 - B54, E2 -E21	Taper Punches	D6, D8
Norbar Products	E22 - E24	Quick Action Wrenches	F4	Sockets Spark Plug	O3	Terminal Tools	N4
Nut Drivers	D12, O19	<b>R</b>		Sockets Specialised	E17 - E19	Testers Circuit	N2 - N5
Nylon Faced Hammers	J9	Radiator Filler	O19	Spanner Sets	C2 -C7, D2 - D4, F2	Thor Hammers & Mallets	J7 - J9
<b>O</b>		Radio Tool Sets	Q6	Spanners	C2 - C7, D2 - D4, F3	Thread Repair Tools	I20, O13
Oil Cans	O17	Ratchet Screwdrivers	C24 - C26	Spanners Combination	C2 - C7, D2, F3	Tinsnips	I17, I18
Oil Filter Removal Tools	C18, D14, O9 - O12	Ratchet Spanners	C3 - C7	Specialised Sockets	E17 - E19	Tool Box / Storage	A4 - A22
Oil Suction Gun	O15, O17	Ratchets	B43 - B47	Speed Wrench	F4	Torches	K7 - K12
Oxygen Sensor Sockets	D15, O22	Rawhide Hammers	J8	Spline Bits & Sockets	B9, B10, B25, B26,	Torque Driver & Wrenches	E22 -E26
<b>P</b>		Reamer	I5	Spot Weld Drills Dormer	Q2	Torque Multipliers	E24
Padlocks	J12	Ribe Sockets & Bits	B23, B24	Spray Guns	L9, L10	Torx* (Star) Bits & Sockets	B9, B10, B19 - B23,
Paint Markers	S38	Ring Spanners	D2, D3, F2	Sprocket Holding Tools	S38	Torx* (Star) Ext Sockets	B11, B12, B30, E6, E8,
Parallel Pin Punches	D6, D8	Rubber Mallets	J9	Star Angle Wrenches	D9, D10, G11, G12	Torx* (Star) Screwdrivers	C21, C22, C24 - C26,
Pick and Hook Sets	D17, J4	<b>S</b>		Star Bits & Sockets	B9, B10, B19 - B23,	Trim Panel Tools	D16, Q3
Pickup Tools	D12, J3	Safety Equipment	R2 - R4	Star External Sockets	B11, B12, B30, E6, E8,	Trimming Knife and Blades	J10, J11
Pipe Bending Tools	P9, P10	Safety Twisting Plier	H3	Star Plus Bits	B11, B21, E13	Tube Cutter and Flaring Sets	D13, P8, P9
Pipe Wrenches	H11	Sanding Discs	I13, I14	Star Ring Spanner Set	D3, F4	Turbomax HSS Drills	I3, I4
Piston Ring Compressor	O2	Scraper Sets	D6, J5	Star Screwdrivers	C21, C22, C24 - C26,	Twisted Knot Brushes	I8, I9
Pliers	C11 - C13, H2, H12 -	Screw Extractor Set	J6	Step Drills Unibit	I5	Tyre Gauges	P16 - P18

	Page No.		Page No.
Tyre Pressure Gauges	P15	Work Lights	K2 - K16
Tyre Tread Depth Gauges	P14, P15	Wrenches Adjustable	D5, F4
Tyre Valve Repair Tool	P14	Wrenches Hexagon	D9, D10, G10 - G12
		Wrenches Torque	E22 - E26
<b>U</b>			
Unibit Step Drills	I5		
Universal Joints	B37, E20		
Utility Knife	J10, J11		
<b>V</b>			
Vacuum Brake Bleeder	O14, P7		
Vacuum Systems Test Kit	P8		
Valve Collet Tool	O2		
Valve Spring Compressors	O2		
VDE Electrical Tools	G5, H15		
Vernier Caliper Gauge	D13, J11		
Vices	I19		
Vise Grip Pliers & Clamps	H4 - H16		
VOSA MoT Approved Tools	P14, Q2		
<b>W</b>			
Water Pump Pliers	C10 - C12, H4, H14,		
Welding Clamps	H10		
Wera Products	G2 - G5, G12		
Wheel Nut Removal Tools	B36, D18, E18		
Wheel Nut Sockets	E4 - E8, E18, E19		
Whip Hose	L7		
Windscreen Tools	Q4, Q5		
Wiper Arm Puller	Q3		
Wire Brushes	I7, I8		
Wire Strippers and Cutters	C11, C12, C18, H2,		
Work Gloves & Knee Pads	R2 - R4		

Part No.	Section	Page No.	Part No.	Section	Page No.	Part No.	Section	Page No.
008C	P	W6	14P250	B	51	170920	D	10
014T	P	14	14P350	B	51	170925	D	10
12E150	B	53	14P50	B	51	170930	D	10
12E250	B	53	14P75	B	51	170940	D	10
12E375	B	53	14PH1	B	9	170950	D	10
12E50	B	53	14PH2	B	9	170960	D	10
12E600	B,B	48,53	14PH3	B	9	170980	D	10
12E75	B	53	14PZ1	B	9	171012	D	8
12P150	B	54	14PZ2	B	9	171016	D	8
12P250	B	54	14PZ3	B	9	17103P	D	8
12P375	B	54	14SL4	B	9	17104P	D	8
12P50	B	54	14SL55	B	9	17104T	D	8
12P75	B	54	14SL7	B	9	17105P	D	8
12W125	B	54	14W100	B	51	17105T	D	8
12W150	B	54	14W150	B	51	17106P	D	8
12W250	B	54	14W250	B	51	17106T	D	8
12W375	B	54	14W350	B	51	1710CP	D	8
12W50	B	54	14W50	B	51	171310	D	6
12W75	B	54	14W75	B	51	171312	D	6
1304	B	16	14X04	B	9	171319	D	6
1305	B	16	14X05	B	9	171322	D	6
1306	B	16	14X06	B	9	17133P	D	6
1307	B	16	14X08	B	9	17133T	D	6
1308	B	16	14X10	B	9	17134C	D	6
1309	B	16	15791	O	20	17134P	D	6
130C	O	4	1603	H	2	17134T	D	6
1310	B	16	1607	J	10	17135P	D	6
1311	B	16	1609	H	3	17135T	D	6
1312	B	16	1610	J	10	17136P	D	6
132C	O	4	1610HD	J	10	1713CC	D	6
136	O	4	1620	D,J	13,10	171410	D	8
137	D,O	13,4	1685	I	5	171412	D	8
14041	P	7	170330	D	6	171414	D	8
1440	G	6	170332	D	6	171416	D	8
14E100	B	50	170350	D	6	1720	I	5
14E150	B	50	170412	D	7	1728F2	D	9
14E250	B	50	170416	D	7	1728H2	D	9
14E350	B	50	170419	D	7	1728HB	D	9
14E50	B	50	170422	D	7	1728R2	D	9
14E75	B	50	170810	D	10	1728S2	D	9
14H03	B	9	170815	D	10	172HR2	D	9
14H04	B	9	170820	D	10	1870P	P	12
14H05	B	9	170825	D	10	18850	P	12
14H06	B	9	170830	D	10	18860	P	12
14H07	B	9	170840	D	10	18H10	B	27
14H08	B	9	170845	D	10	18H12	B	27
14P100	B	51	170850	D	10	18H14	B	27
14P150	B	51	170910	D	10	18H17	B	27
Part No.	Section	Page No.	Part No.	Section	Page No.	Part No.	Section	Page No.



Part No.	Section	Page No.	Part No.	Section	Page No.	Part No.	Section	Page No.
18H8	B	27	2305	B	17	2604	B	18
18H9	B	27	2306	B	17	2605	B	18
18S10	B	27	2307	B	17	2606	B	18
18S11	B	27	2308	B	17	2607	B	18
18S12	B	27	2309	B	17	2608	B	18
18S13	B	27	2310	B	17	2609	B	18
18S14	B	27	2311	B	17	2610	B	18
18S38	B	27	2312	B	17	2611	B	18
18S516	B	27	2313	B	17	2612	B	18
18S7	B	27	2314	B	17	270210	D	2
18S8	B	27	24H03	B	10	270211	D	2
18T45	B	27	24H04	B	10	270212	D	2
18XS10	B	27	24H05	B	10	270213	D	2
18XT10	B	27	24H06	B	10	270214	D	2
19801	P	2	24H07	B	10	270215	D	2
19802	P	2	24H08	B	10	270216	D	2
19804	P	2	24PH1	B	10	270217	D	2
19805	P	2	24PH2	B	10	270218	D	2
19809	P	2	24PH3	B	10	270219	D	2
19851	P	2	24PZ1	B	10	271067	D	2
19852	P	2	24PZ2	B	10	271089	D	2
19853	P	2	24PZ3	B	10	271111	D	2
19854	P	2	24SL4	B	10	271123	D	2
19856	P	2	24SL55	B	10	271145	D	2
19857	P	2	24SL7	B	10	271167	D	2
19858	P	2	24TP09	B	10	271189	D	2
19891	P	2	24TP10	B	10	271202	D	2
19892	P	2	24TP15	B	10	274068	D	3
19893	P	2	24TP20	B	10	274102	D	3
19894	P	2	24TP25	B	10	274148	D	3
2024CP	D	16	24TP27	B	10	274204	D	3
2024DP	D	16	24TP30	B	10	275101	D	3
2024GS	D	16	24TP40	B	10	275123	D	3
2024VP	D	16	24X04	B	10	275145	D	3
202730	D	17	24X05	B	10	275167	D	3
202739	D	17	24X06	B	10	275189	D	3
20273H	D	17	24X08	B	10	276089	D	4
20273S	D	17	24X10	B	10	276101	D	4
20274A	D	17	2500	G	6	276123	D	4
20275C	D	17	2504	B	17	276145	D	4
20275S	D	17	2505	B	17	276167	D	4
202990	D	17	2506	B	17	276189	D	4
2029CP	D	17	2507	B	17	280306	D	11
2029HP	D	17	2508	B	17	280314	D	11
2029SP	D	17	2509	B	17	280338	D	11
2070	H	3	2510	B	17	280505	D	12
2080	H	3	2511	B	17	280506	D	12
2304	B	17	2512	B	17	280507	D	12

Part No.	Section	Page No.	Part No.	Section	Page No.	Part No.	Section	Page No.
280508	D	12	40/A2	I	8	4909	B	19
280510	D	12	40/A3	I	8	4910	B	19
30M	I	2	40/A4	I	8	4911	B	19
318	O	13	400	J	6	4912	B	19
3181	O	13	40M	I	2	49M	I	2
3182	O	13	4100	G	8	500MM	G	8
3183	O	13	4130	E	20	50M	I	2
3184	O	13	417	I	7	51M	I	2
3185	O	13	418	I	7	520	P	14
31M	I	2	419	I	7	52M	I	2
32M	I	2	41M	I	2	5306	B	31
33M	I	2	42M	I	2	5307	B	31
34M	I	2	4306	B	30	5308	B	31
35M	I	2	4307	B	30	5310	B	31
363	J	12	4308	B	30	5312	B	31
364	J	12	4309	B	30	5313	B	31
365	J	12	4310	B	30	5314	B	31
366	J	12	4311	B	30	5317	B	31
36M	I	2	4312	B	30	53M	I	2
37M	I	2	4313	B	30	5406	B	32
38E150	B	52	4314	B	30	5408	B	32
38E250	B	52	4316	B	30	5409	B	32
38E350	B	52	4317	B	30	5410	B	32
38E50	B	52	4319	B	30	5412	B	32
38E600	B,B	48,52	4340	E	15	5414	B	32
38E75	B	52	43M	I	2	54M	I	2
38M	I	2	4416	O	7	55M	I	2
38P150	B	53	44M	I	2	562004	B	25
38P250	B	53	450	J	6	562005	B	25
38P350	B	53	4588	N	5	562006	B	25
38P50	B	53	45M	I	2	562008	B	25
38P75	B	53	46M	I	2	562010	B	25
38PH1	B	26	47M	I	2	562012	B	25
38PH2	B	26	4804	B	18	562014	B	25
38PH3	B	26	4805	B	18	562104	B	26
38PZ1	B	26	4806	B	18	562105	B	26
38PZ2	B	26	4807	B	18	562106	B	26
38PZ3	B	26	4808	B	18	562108	B	26
38SL55	B	26	4809	B	18	562110	B	26
38SL65	B	26	4810	B	18	562112	B	26
38SL8	B	26	4811	B	18	562114	B	26
38W150	B	52	4812	B	18	562204	B	25
38W250	B	52	48M	I	2	562205	B	25
38W35	B	52	4904	B	19	562206	B	25
38W350	B	52	4905	B	19	562208	B	25
38W50	B	52	4906	B	19	562210	B	25
38W75	B	52	4907	B	19	562212	B	25
39M	I	2	4908	B	19	562214	B	25

Part No.	Section	Page No.	Part No.	Section	Page No.	Part No.	Section	Page No.
56M	I	2	710113	B	24	810H17	E	8
57M	I	2	710114	B	24	810H19	E	8
5806	B	24	71F	I	3	810H22	E	8
5807	B	24	72F	I	3	810H24	E	8
5808	B	24	73F	I	3	810T60	E	8
5809	B	24	74F	I	3	810T70	E	8
5810	B	24	75F	I	3	810T80	E	8
5812	B	24	76F	I	3	810T90	E	8
5813	B	24	77F	I	3	81412	B,E	42, 6
5814	B	24	78F	I	3	81414	B,E	42, 6
60F	I	3	790010	C	8	81416	B,E	42, 6
61F	I	3	790011	C	8	81418	B,E	42, 6
62F	I	3	790012	C	8	81F	I	3
63F	I	3	790013	C	8	81T100	E	8
64F	I	3	790014	C	8	82F	I	3
65F	I	3	790015	C	8	83F	I	3
66F	I	3	790016	C	8	84/6	I	8
67F	I	3	790017	C	8	84F	I	3
68F	I	3	790018	C	8	85F	I	3
6920	C	11	790019	C	8	86F	I	3
6921	C	11	790021	C	8	87F	I	3
6922	C	11	790022	C	8	88F	I	3
6923	C	11	790024	C	8	900MM	G	9
6932	C	11	79F	I	3	9168D	I	6
6950	C	11	80919	E	7	92-12	F	4
6960	C	11	80921	E	7	92-8	F	4
6980	C	11	80922	E	7	9200	I	8
6995	C	11	80924	E	7	9204	I	8
69F	I	3	80927	E	7	9206	I	8
70F	I	3	80930	E	7	9251D	I	6
710004	B	23	80932	E	7	9265	I	9
710005	B	23	80933	E	7	9268D	I	6
710006	B	23	80934	E	7	9500	F	4
710007	B	23	80935	E	7	9506	D,F	5,4
710008	B	23	80936	E	7	9508	D,F	5,4
710009	B	23	80938	E	7	9510	D,F	5,4
710010	B	23	80940	E	7	9512	D,F	5,4
710012	B	23	80941	E	7	9515	D,F	5,4
710013	B	23	80946	E	7	9548D	I	9
710014	B	23	80950	E	7	9730	G	5
710104	B	24	80955	E	7	9824	J	2
710105	B	24	80F	I	3	9836	J	2
710106	B	24	810A1	E	8	9840	J	2
710107	B	24	810A34	E	8	984200	J	2
710108	B	24	810E18	E	8	984300	J	2
710109	B	24	810E20	E	8	984450	J	2
710110	B	24	810E22	E	8	984600	J	2
710112	B	24	810E24	E	8	9893	O	19

Part No.	Section	Page No.	Part No.	Section	Page No.	Part No.	Section	Page No.
98936	O	19	A04408	I	15	A23407	G	7
98937	O	19	A04409	I	15	A23410	G	7
98938	O	19	A04521	I	16	A23413	G	8
9894	O	19	A04524	I	16	A23414	G	8
A0046L	R	2	A04531	I	16	A23416	G	8
A0046X	R	2	A04634	E	17	A23417	G	8
A02202	I	3	A04635	E	17	A23418	G	8
A02203	I	3	A05483	H	12	A23501	G	8
A02204	I	3	A05493	H	12	A23502	G	8
A02205	I	3	A05494	H	12	A24R	H	7
A02206	I	3	A05495	H	12	A24SP	H	6
A02210	I	3	A05504	H	13	A31012	N	4
A02211	I	3	A05506	H	13	A317M	R	2
A02215	I	3	A05517	H	13	A317X	R	2
A02218	I	3	A05518	H	13	A35097	H	14
A02220	I	3	A05519	H	15	A38098	G	5
A02221	I	3	A05865	H	15	A39410	E	17
A02222	I	3	A05869	H	15	A4010L	R	2
A02223	I	3	A05871	H	15	A4010X	R	2
A02224	I	3	A05873	H	15	A46008	O	15
A02225	I	3	A05876	H	14	A46009	O	16
A02226	I	3	A05943	H	14	A46011	O	16
A02227	I	3	A07189	H	10	A46012	O	16
A02228	I	3	A07627	H	15	A4608S	O	15
A02229	I	3	A07628	H	15	A4609S	O	16
A02230	I	3	A07629	H	15	A4611S	O	16
A02231	I	3	A07793	J	11	A4LN	H	5
A02232	I	3	A07794	J	11	A4LW	H	9
A02233	I	4	A07795	J	11	A4SP	H	6
A03642	H	11	A08017	H	4	A4WR	H	6
A03826	R	2	A08018	H	4	A50504	H	16
A03827	R	2	A08019	H	4	A50507	H	16
A03830	R	4	A08020	H	4	A50508	H	16
A03831	R	4	A08104	J	11	A50510	H	16
A03832	R	4	A10LW	H	9	A54125	E	17
A03990	I	5	A10R	H	5	A5WR	H	6
A03991	I	5	A10WR	H	6	A6501L	R	3
A03992	I	5	A11R	H	7	A6501X	R	3
A04240	J	10	A11SP	H	6	A65171	J	6
A04314	I	17	A12LC	H	7	A6999	D	11
A04315	I	17	A13	A	22	A6LN	H	5
A04316	I	18	A18DR	H	7	A6R	H	7
A04373	G	6	A18R	H	7	A6SP	H	6
A04374	G	6	A18SP	H	6	A70905	S	37
A04375	G	6	A208	I	16	A71	H	8
A04376	G	6	A20AIR	L	6	A723	Q	2
A04385	G	7	A20R	H	10	A723+B	Q	2
A04407	I	15	A23377	G	7	A7236	Q	2

Part No.	Section	Page No.	Part No.	Section	Page No.	Part No.	Section	Page No.
A73	H	8	ABSM5	I	11	AF2702	D	2
A76	H	9	ABSM6	I	11	AF2704	D	3
A7621L	R	3	ABSM7	I	11	AF2705	D	3
A7621X	R	3	AC040	P	5	AF2706	D	4
A78116	H	14	ACAT1	Q	2	AF2708	D	5
A78120	H	14	ACH25	J	7	AF2709	D	6
A7LW	H	9	ACH40	J	7	AF2714	D	4
A7R	H	5	ADAC43	P	17	AF2803	D	11
A7WR	H	6	ADAC44	P	17	AF2805	D	12
A8247L	R	3	ADAC45	P	17	AF2901	P	8
A8247X	R	3	ADAC46	P	17	AF2905	D	12
A88437	J	11	ADPG1	P	17	AF2906	D	13
A8R	H	10	ADTG4	P	16	AF2920	P	8
A9524	I	17	ADTPG7	P	15	AF2950	P	8
A9AC	H	10	AE47BK	S	38	AF2954	P	8
A9LN	H	5	AE47BU	S	38	AF2960	P	8
A9R	H	10	AE47R	S	38	AF401	P	7
AB08NF	I	7	AEMV3	I	19	AF402	P	7
AB1003	I	6	AEMV6	I	19	AF403	P	9
AB10BN	I	7	AF1703	D	6	AF404	P	7
AB10CB	I	7	AF1704	D	7	AF410	P	7
AB10FC	I	7	AF1708	D	10	AF576	P	4
AB10OV	I	7	AF1709	D	10	AF582	O	21
AB10PN	I	7	AF1710	D	8	AF7100	C	2
AB10RN	I	7	AF1713	D	6	AF7101	C	2
AB1502	I	9	AF1714	D	8	AF7105	C	3
ABEW88	I	12	AF1718	D	9	AF7106	C	3
ABF540	I	9	AF1720	D	9	AF7107	C	3
ABF560	I	9	AF1724	D	6	AF7108	C	3
ABF580	I	9	AF2003	P	8	AF7109	C	3
ABF5PB	I	12	AF2004	P	8	AF7110	C	2
ABJ20	J	5	AF2006	P	8	AF7111	C	2
ABP25	I	13	AF2014	D	15	AF7112	C	2
ABP330	I	12	AF2015	D	15	AF7113	C	2
ABP350	I	12	AF2020	D	13	AF7114	C	2
ABPH16	J	6	AF2021	D	13	AF7115	C	2
ABPH24	J	6	AF2023	D	14	AF7116	C	2
ABPH32	J	6	AF2024	D	16	AF7117	C	2
ABPH40	J	6	AF2025	D	16	AF7118	C	2
ABPH48	J	6	AF2026	D	16	AF7119	C	2
ABPHBS	I	12	AF2027	D	17	AF7120	C	2
ABSCRA	I	7	AF2029	D	17	AF7121	C	2
ABSD42	G	8	AF2032	D	14	AF7122	C	2
ABSM	I	10	AF2035	D	15	AF7124	C	2
ABSM1	I	10	AF2070	D	15	AF7127	C	2
ABSM2	I	10	AF2124	D	18	AF7130	C	2
ABSM3	I	10	AF214	C	10	AF7132	C	2
ABSM4	I	11	AF2701	D	2	AF7200	C	3

Part No.	Section	Page No.	Part No.	Section	Page No.	Part No.	Section	Page No.
AF7210	C	3	AF7509	C	7	AFBW24	B	35
AF7211	C	3	AF7510	C,C	6,7	AFBW27	B	35
AF7212	C	3	AF7511	C	6	AFBW3	B	36
AF7213	C	3	AF7512	C	6	AFBW31	B	36
AF7214	C	3	AF7513	C	6	AFBW32	B	36
AF7215	C	3	AF7514	C	6	AFBW33	B	36
AF7216	C	3	AF7515	C	6	AFBW6	B	35
AF7217	C	3	AF7516	C	6	AFBW7	B	36
AF7218	C	3	AF7517	C	6	AFBW71	B	36
AF7219	C	3	AF7518	C	6	AFBW72	B	36
AF7300	C	4	AF7519	C	6	AFBW73	B	36
AF7304	C	4	AF7521	C	6	AFBW74	B	36
AF7305	C	5	AF7522	C	6	AFBW75	B	36
AF7306	C	5	AF7524	C	6	AFBW76	B	36
AF7307	C	5	AF7527	C	6	AFBW77	B	36
AF7308	C	5	AF7600	C	7	AFG43	P	17
AF7309	C	5	AF7608	C	7	AFG44	P	17
AF7310	C	4	AF7609	C	7	AFG45	P	17
AF7311	C	4	AF7610	C	7	AFG46	P	17
AF7312	C	4	AF7611	C	7	AFG5H	P	16
AF7313	C	4	AF7612	C	7	AFH42	J	7
AF7314	C	4	AF7613	C	7	AFH44	J	7
AF7315	C	4	AF7614	C	7	AFR1	L	8
AF7316	C	4	AF7615	C	7	AFRLC1	L	9
AF7317	C	4	AF7616	C	7	AFS10	P	14
AF7318	C	4	AF7617	C	7	AFT001	D	18
AF7319	C	4	AF7618	C	7	AFT002	D	18
AF7321	C	4	AF7619	C	7	AFT003	D	18
AF7322	C	4	AF7900	C	8	AFT004	D	18
AF7324	C	4	AF7950	C	8	AFT005	D	18
AF7327	C	4	AF7970	C	8	AFT006	D	18
AF7400	C	5	AF903	O	19	AFT007	D	18
AF7410	C	5	AFB01	B	35	AFT008	D	18
AF7411	C	5	AFB10	B	35	AFT009	D	18
AF7412	C	5	AFB11	B	35	AFT010	D	18
AF7413	C	5	AFB12	B	35	AFT011	D	18
AF7414	C	5	AFB13	B	35	AFT014	D	18
AF7415	C	5	AFB14	B	35	AFT015	D	18
AF7416	C	5	AFB15	B	35	AFT020	D	18
AF7417	C	5	AFB16	B	35	AFT021	D	18
AF7418	C	5	AFB17	B	35	AFT030	D	18
AF7419	C	5	AFB18	B	35	AFT15	D	18
AF7500	C	6	AFB19	B	35	AFT24	D	18
AF7504	C	6	AFBMC3	D	13	AFT25	D	18
AF7505	C	7	AFBW17	B	35	AFT26	D	18
AF7506	C	7	AFBW19	B	35	AH2022	L	7
AF7507	C	7	AFBW21	B	35	AH2044	L	7
AF7508	C	7	AFBW22	B	35	AH2108	L	7



Part No.	Section	Page No.	Part No.	Section	Page No.	Part No.	Section	Page No.
AH2109	L	7	APT20	L	6	AT4124	S,S	5,21
AH2116	L	7	APT702	L	2	AT4126	S	5
AH2134	L	7	APT719	L	3	AT4224	S	24
AH2139	L	7	APT75F	I	13	AT4256	S,S,S	22,25,35
AH2141	L	7	ARRT2	Q	6	AT428	S	25
AH2142	L	7	AS1224	N	5	AT4300	S	15
AH2149	L	7	ASDK3	I	12	AT4320	S,S,S	16,18,37
AH2150	L	8	ASG01P	L	9	AT4322	S	17
AH5213	L	8	ASG02P	L	10	AT4324	S,S	17,18
AH5220	L	8	ASH10	J	7	AT4408	S,S	8,22
AHB103	L	8	AST12	E	21	AT4409	S,S	9,23
AM5530	N	6	AST14	E	21	AT4411	S,S,S	9,21,23
AM7201	O	14	AST38	E	21	AT4413	S	27
AM7205	O	14	AT01T	H	10	AT4414	S	29
AM8550	N	7	AT03T	H	10	AT4415	S	28
AM8900	N	7	AT05T	H,C	10,10	AT4416	S	32
AMT32	N	4	AT07T	H,C	10,10	AT4417	S	29
ANDP7	O	19	AT09T	H	10	AT4418	S	31
AP100	K	5	AT14T	H	10	AT4419	S	28
AP10Y	K	5	AT15T	H	10	AT4420	S	30
AP25R	K	6	AT172	O	7	AT4427	S	31
AP37BL	K	4	AT1770	O	8	AT4443	S	32
AP37G	K	4	AT1780	N	4	AT4445	S	33
AP37O	K	4	AT210	P	10	AT4490	S	10
AP37R	K	4	AT214	H	11	AT4502	S,S,S	2,12,35
AP37Y	K	4	AT2806	O	5	AT4504	S	35
APA91	I	6	AT2808	O	5	AT4530	S,S	19,36
APA92	I	13	AT2810	O	5	AT4609	S,S	2,11
APA93	I	14	AT2814	O	5	AT4612	S,S	2,12
APA94	I	14	AT3111	O	15	AT4624	S,S	11,14
APA95	I	14	AT3132	O	13	AT4910	S,S,S,S	
APF51	I	13	AT3135	O	13	AT578	O	21
APF53	I	13	AT3155	O	13	AT6429	Q	2
APF56	I	13	AT3175	O	13	AT6808	N	6
APMBE	S	38	AT3205	O	13	AT6910	N	7
APMBK	S	38	AT3225	O	13	AT6970	O	4
APMR	S	38	AT3729	O	9	AT818	E	5
APMW	S	38	AT4098	S,S	3,14	AT842	D,J	13,11
APMY	S	38	AT4113	S	4	AT8702	P	14
APP200	L	3	AT4114	S	3	AT8703	P	14
APP203	L	2	AT4115	S	4	AT872	P	13
APPMT	J	12	AT4116	S	5	AT9710	P	3
APPSK	J	12	AT4117	S	6	AT9760	J	3
APS2L	R	5	AT4118	S	4	ATDG1	D,P	13,15
APS2M	R	5	AT4119	S,S	7,21	ATDR30	P	18
APS2XL	R	5	AT4120	S	6	ATDR40	P	18
APS2XX	R	5	AT4121	S	8	AU1M	I	5
APS517	R	5	AT4122	S	6	AU4M	I	5

Part No.	Section	Page No.	Part No.	Section	Page No.	Part No.	Section	Page No.
AU5M	I	5	BNNBX	K	15	CD015	I	2
AW10	Q	4	BNNBY	K	15	CD020	I	2
AW11	Q	4	BNBUDY	K	14	CD025	I	2
AW1575	G	5	BNE100	K	12	CD030	I	2
AW20	Q	4	BNGHAZ	K	13	CD035	I	2
AW21	Q	4	BNGM12	K	13	CD040	I	2
AW22	Q	4	BNGSTM	K	13	CD045	I	2
AW2441	G	4	BNGSTR	K	13	CD050	I	2
AW30	Q	5	BNI700	K	6	CD055	I	2
AW31	Q	5	BNKSTR	K	14	CD060	I	2
AW3825	G	4	BNLGRD	K	15	CD065	I	2
AW40	Q	5	BNLW	K	7	CD070	I	2
AW43	Q	5	BNM100	K	7	CD075	I	2
AW44	Q	5	BNRS70	K	14	CD080	I	2
AW5656	G	2	BNRS7B	K	14	CD085	I	2
AW8062	G	3	BNRSP	K	10	CD090	I	2
AW8287	G	3	BNSBLD	K	6	CD095	I	2
AWEZSN	I	18	BNSS11	K	16	CD100	I	2
AZ4.35	N	8	BNSS40	K	16	CD105	I	2
AZ415	N	8	BNTRIS	K	7	CD110	I	2
AZ416	N	8	BNWSTR	K	16	CD120	I	2
AZ4166	N	8	BPATM	N	2	CD130	I	2
AZ4181	N	8	BPECB	N	3	CD19	I	2
B00852	K	8	BPRS	Q	3	E57702	F	4
B00900	K	12	BPSTLK	N	2	F028	P	4
B5602	K	11	BT307	G	9	FAS15	B	34
B5605R	K	9	BT308	G	9	FAS17	B,B	33,34
B5606R	K	11	BT309	G	9	FAS19	B,B	33,34
B7298	K	8	BT310	G	10	FAS21	B,B	33,34
B7299R	K	8	BUPKIT	N	3	FAS22	B	34
B7396R	K	9	C1	O	17	FAS23	B	33
B8404	K	10	C111	O	17	FAS24	B	34
B9608R	K	12	C112	O	17	FAS27	B	33
BF2001	P	9	C115	O	17	FASKIA	B	33
BFC280	K	3	C117	O	15	FASMER	B	33
BFUSET	N	5	C118	O	15	FB40	P	18
BG5007	L	5	C119	O	15	FB404	F	4
BG5009	L	5	C125	O	17	FB601	F	2
BIF4R	K	3	C126	O	16	FB602	F	3
BIF8R	K	3	C127	O	17	FB603	F	3
BIW4R	K	2	C150	O	18	FB606	F	3
BIW5R	K	2	C200	O	18	FB607	F	3
BIW5RF	K	2	C250	O	18	FB608	F	3
BIW7R	K	2	C355	O	17	FB609	F	3
BLEDF3	K	5	C500	O	17	FB610	F	3
BN580R	K	9	C7	O	17	FB611	F	3
BNNBN	K	15	C9	O	17	FB612	F	3
BNNBR	K	15	CD010	I	2	FB613	F	3

Part No.	Section	Page No.	Part No.	Section	Page No.	Part No.	Section	Page No.
FB614	F	3	FP16	C, H	11, 4	FT212	E	3
FB615	F	3	FP2	C, H	11, 4	FT213	E	3
FB616	F	3	FP30	H	2	FT214	E	3
FB617	F	3	FP301	H	2	FT215	E	3
FB618	F	3	FP302	H	2	FT216	E	3
FB619	F	3	FP303	H	2	FT217	E	3
FB620	F	3	FP3S	H	4	FT218	E	3
FB621	F	3	FT1015	E	14	FT219	E	3
FB622	F	3	FT108	E	10	FT221	E	3
FB623	F	3	FT1098	E	9	FT222	E	3
FB624	F	3	FT110	E	10	FT224	E	3
FB625	F	3	FT111	E	10	FT227	E	3
FB626	F	3	FT112	E	10	FT230	E	3
FB627	F	3	FT113	E	10	FT232	E	3
FB628	F	3	FT114	E	10	FT308	E	2
FB630	F	3	FT115	E	10	FT309	E	2
FB632	F	3	FT116	E	10	FT310	E	2
FB633	F	3	FT117	E	10	FT311	E	2
FB634	F	3	FT118	E	10	FT312	E	2
FB636	F	3	FT119	E	10	FT313	E	2
FB638	F	3	FT1201	E	21	FT314	E	2
FB641	F	3	FT1202	E	21	FT315	E	2
FB646	F	3	FT1204	E	21	FT316	E	2
FB650	F	3	FT1205	E	21	FT317	E	2
FB701	F	2	FT1207	O	3	FT318	E	2
FB702	F	2	FT1208	O	3	FT319	E	2
FB802	F	4	FT1210	E	21	FT321	E	2
FIH10	B	40	FT1217	E	21	FT322	E	2
FIH11	B	40	FT1234	E	19	FT3401	B	6
FIH12	B	40	FT1238	E	19	FT3412	E	19
FIH14	B	40	FT1401	E	20	FT3491	B	6
FIH17	B	40	FT1403	E	20	FT3494	E	9
FIH19	B	40	FT1406	E	20	FT3498	E	9
FIH6	B	40	FT1407	E	20	FT3800	E	20
FIH7	B	40	FT1410	E	9	FT3801	E	20
FIH8	B	40	FT1438	B,E	48,19	FT3803	E	20
FIH9	B	40	FT2001	B	37	FT3804	E	20
FIS10	B	41	FT2002	B	37	FT3806	E	20
FIS15	B	41	FT201	B	37	FT3807	O	3
FIS20	B	41	FT202	B	37	FT3808	O	3
FIS25	B	41	FT203	B	37	FT3809	E	20
FIS27	B	41	FT204	B	37	FT3812	E	19
FIS30	B	41	FT205	B	37	FT3817	E	20
FIS40	B	41	FT206	B	37	FT3818	B,E	48,9
FIS45	B	41	FT208	E	3	FT3819	E	21
FIS50	B	41	FT209	E	3	FT408	E	9
FIS55	B	41	FT210	E	3	FT410	E	9
FL5	K	10	FT211	E	3	FT411	E	9

Part No.	Section	Page No.	Part No.	Section	Page No.	Part No.	Section	Page No.
FT412	E	9	FT740	E	4	GF3102	C	12
FT413	E	9	FT741	E	4	GF3103	C	12
FT414	E	9	FT808	E	3	GF311	C	12
FT415	E	9	FT809	E	3	GF3111	C	12
FT416	E	9	FT810	E	3	GF3112	C	12
FT417	E	9	FT811	E	3	GF3113	C	12
FT418	E	9	FT812	E	3	GF313	C	13
FT419	E	9	FT813	E	3	GF3131	C	13
FT576	P	10	FT814	E	3	GF3132	C	13
FT624	E	5	FT815	E	3	GF3133	C	13
FT627	E	5	FT816	E	3	GF316	C	13
FT630	E	5	FT817	E	3	GF3161	C	13
FT632	E	5	FT818	E	3	GF3162	C	13
FT633	E	5	FT819	E	3	GF3163	C	13
FT634	E	5	FT821	E	3	GF407	C	14
FT635	E	5	FT822	E	3	GF4071	C	14
FT636	E	5	FT823	E	3	GF4072	C	14
FT641	E	5	FT824	E	3	GF4073	C	14
FT707	E	18	FT910	E	11	GF4074	C	14
FT7071	E	18	FT911	E	11	GF409	C	14
FT7072	E	18	FT912	E	11	GF4091	C	14
FT7073	E	18	FT913	E	11	GF4092	C	14
FT7074	E	18	FT914	E	11	GF4093	C	14
FT7075	E	18	FT915	E	11	GF4094	C	14
FT7076	E	18	FT916	E	11	GF413	C	15
FT7077	E	18	FT917	E	11	GF4131	C	15
FT710	E	4	FT918	E	11	GF4132	C	15
FT711	E	4	FT919	E	11	GF4133	C	15
FT712	E	4	FT920	E	11	GF4134	C	15
FT713	E	4	FT921	E	11	GFB10M	C	23
FT714	E	4	FT922	E	11	GFB9PP	C	26
FT715	E	4	FT924	E	11	GFB9S	C	26
FT716	E	4	FT927	E	11	GFB9SH	C	26
FT717	E	4	FT930	E	11	GFB9TS	C	26
FT718	E	4	FT932	E	11	GFDP6	C	19
FT719	E	4	GF016	C	10	GFDP7	C	19
FT721	E	4	GF020	C	10	GFDPH1	C	19
FT722	E	4	GF026H	C	23	GFDPH2	C	19
FT724	E	4	GF026M	C	23	GFDPH3	C	19
FT726	E	4	GF032	C	22	GFDSL5	C	19
FT727	E	4	GF059H	C	24	GFDSL6	C	19
FT730	E	4	GF059M	C	25	GFDSL8	C	19
FT732	E	4	GF308	C	11	GFE75	C	26
FT733	E	4	GF3081	C	11	GFFP3	C	11
FT734	E	4	GF3082	C	11	GFG10L	C	17
FT735	E	4	GF3083	C	11	GFG10R	C	16
FT736	E	4	GF310	C	12	GFG10W	C	16
FT738	E	4	GF3101	C	12	GFG11C	C	17

Part No.	Section	Page No.	Part No.	Section	Page No.	Part No.	Section	Page No.
GFG11F	C	18	GFTS20	C	22	HDB861	R	8
GFG11H	C	17	GFTS25	C	22	HDB881	R	8
GFG2P	C	15	GFTS27	C	22	HDB891	R	8
GFG5W	C	16	GFTS30	C	22	HDB901	R	8
GFG6L	C	16	GFW06	C	18	HDB911	R	8
GFG7P	C	15	GFW3	C	18	HDB921	R	8
GFG7W	C	16	GFWSA	C	18	HDB931	R	8
GFG9L	C	16	GFWSC	C	18	HDB981	R	8
GFG9P	C	15	HDB201	R	5	HDB991	R	8
GFGJ1	C	16	HDB211	R	5	HDG204	R	5
GFGJ2	C	16	HDB221	R	5	HDG214	R	5
GFGJ3	C	17	HDB225	R	6	HDG224	R	5
GFGJ5	C	17	HDB231	R	6	HDG228	R	6
GFM100	C	26	HDB235	R	6	HDG234	R	6
GFM50	C	26	HDB271	R	6	HDG238	R	6
GFPH1	C	21	HDB291	R	5	HDG274	R	6
GFPH2	C	21	HDB311	R	6	HDG294	R	5
GFPH22	C	21	HDB321	R	8	HDG314	R	6
GFPH3	C	21	HDB331	R	8	HDG324	R	8
GFPZ1	C	21	HDB351	R	6	HDG334	R	8
GFPZ2	C	21	HDB361	R	6	HDG354	R	6
GFRF14	C	26	HDB421	R	8	HDG364	R	6
GFRS9	C	24	HDB451	R	8	HDG424	R	8
GFS106	C	26	HDB461	R	8	HDG454	R	8
GFS107	C	26	HDB471	R	8	HDG464	R	15
GFS10W	C	17	HDB481	R	8	HDG474	R	8
GFS214	C	19	HDB491	R	8	HDG484	R	8
GFS246	C	19	HDB501	R	6	HDG494	R	8
GFS2F	C	20	HDB511	R	7	HDG504	R	7
GFS2P	C	21	HDB571	R	7	HDG514	R	7
GFS2T	C	21	HDB581	R	7	HDG574	R	7
GFS2TL	C	22	HDB591	R	8	HDG584	R	7
GFS7R	C	17	HDB601	R	7	HDG594	R	8
GFS9L	C	17	HDB611	R	7	HDG604	R	7
GFSL3	C	20	HDB621	R	13	HDG614	R	7
GFSL4	C	20	HDB631	R	7	HDG624	R	7
GFSL42	C	20	HDB651	R	7	HDG634	R	7
GFSL55	C	20	HDB661	R	7	HDG654	R	7
GFSL65	C	20	HDB701	R	7	HDG664	R	7
GFSL8	C	20	HDB705	R	7	HDG704	R	10
GFST10	C	21	HDB721	R	7	HDG708	R	7
GFST15	C	21	HDB781	R	7	HDG724	R	7
GFST20	C	21	HDB785	R	7	HDG784	R	7
GFST25	C	21	HDB801	R	7	HDG788	R	7
GFST27	C	21	HDB805	R	7	HDG804	R	7
GFST30	C	21	HDB811	R	7	HDG808	R	7
GFTS10	C	22	HDB815	R	7	HDG814	R	7
GFTS15	C	22	HDB851	R	8	HDG818	R	7

Part No.	Section	Page No.	Part No.	Section	Page No.	Part No.	Section	Page No.
HDG854	R	8	PC4279	L	12	R1SQ	E	24
HDG864	R	8	PC4280	L	12	R2	I	17
HDG884	R	8	PC4281	L	13	R2068A	M	3
HDG904	R	8	PC5656	L	12	R2082B	M	3
HDG914	R	8	PC5JF	L	12	R2082T	M	4
HDG924	R	8	PC5JM	L	12	R2094A	M	4
HDG934	R	8	PC6475	L	13	R210	I	17
HDG984	R	8	PC6560	L	13	R2119A	M	4
HDG994	R	8	PC6582	L	11	R30101	E	23
J15QM	L	3	PC6889	L	13	R30103	E	23
J2235Q	L	4	PC6892	L	13	R30104	E	23
J285B6	L	4	PC6893	L	13	R30105	E	23
J35MAX	L	4	PC6895	L	13	R30106	E	23
JLA437	L	5	PC6896	L	13	R34SQ	E	24
JW5132	M	2	PC6897	L	13	R3MULT	M	5
JW5152	M	2	PC6898	L	13	R5MULT	M	5
JW7152	M	2	PC6899	L	13	R6056E	M	7
M52468	I	5	PC6900	L	13	R804AE	M	6
NPE090	O	14	PC6901	L	13	RB1207	M	8
PC101	L	9	PC6904	L	12	RB1212	M	8
PC1206	L	12	PC6905	L	12	RB1242	M	8
PC1217	L	12	PC6909	L	11	RB2027	M	8
PC1226	L	11	PC7102	L	14	RB2042	M	8
PC1793	L	11	PC7103	L	14	RB2047	M	8
PC21CF	L	10	PC7106	L	14	RB854	M	8
PC21CM	L	10	PC7112	L	14	RC1242	M	8
PC21EF	L	10	PC71CF	L	14	RC2027	M	8
PC21EM	L	10	PC71CM	L	14	RC2042	M	8
PC21JF	L	10	PC71EF	L	14	RC854	M	8
PC21JM	L	10	PC71EM	L	14	RCG12	M	8
PC21R	L	10	PC91CF	L	14	RF42D	A	10
PC21S	L	10	PC91CM	L	14	RF42RC	A	8
PC21T	L	10	PC91EF	L	14	RF42TB	A	6
PC2479	L	12	PC91EM	L	14	RG1207	M	7
PC2486	L	11	PC91JF	L	14	RG219A	M	6
PC2487	L	11	PC91JM	L	14	RG219T	M	6
PC2488	L	11	PC91R	L	14	RN3AR	E	24
PC2593	L	11	PC91S	L	14	RN4R	E	24
PC2746	L	11	PC91T	L	14	RN5AR	E	24
PC2808	L	12	PCS21F	L	14	RN5R	E	24
PC2951	L	12	PCS21M	L	14	RNHT3	E	24
PC2954	L	12	R1	I	17	RNHT31	E	24
PC2983	L	12	R1208A	M	6	RNT20	E	22
PC2984	L	12	R1268A	M	3	RNT201	E	22
PC2985	L	12	R13850	E	22	RNT400	E	23
PC2986	L	12	R13851	E	22	RS214F	M	6
PC3035	L	12	R13852	E	22	RST72	A	12
PC3036	L	12	R1C	I	17	SE100	E	12



Part No.	Section	Page No.	Part No.	Section	Page No.	Part No.	Section	Page No.
SE104	B,E	12,12	T4408	E	15	TA360	O	11
SE105	B,E	12,12	T4410	E	15	TA361	O	11
SE106	B,E	12,12	T4412	E	15	TA362	O	11
SE107	B,E	12,12	T5304	E	15	TA363	O	11
SE108	B,E	12,12	T5305	E	15	TA364	O	11
SE110	B,E	12,12	T5306	E	15	TA372	O	9
SE111	B,E	12,12	T5307	E	15	TA374	D,O	14,10
SE112	B,E	12,12	T5308	E	15	TA375	D,O	14,10
SE114	B,E	12,12	T5310	E	15	TA376	O	10
SE116	B,E	12,12	T5312	E	15	TA377	O	11
SE200	E	12	T5405	E	15	TA38	O	10
SE210	B	30	T5406	E	15	TA380	O	12
SE211	B	30	T5408	E	15	TA381	O	10
SE212	B	30	T5410	E	15	TA3827	O	18
SE214	B	30	T5412	E	15	TA384	O	10
SE216	B,B	12,30	TA112	O	2	TA389	O	15
SE218	B,B	12,30	TA130	P	11	TA39	O	9
SE220	B,B	12,30	TA135	P	11	TA390	O	12
SE222	B,B	12,30	TA136	P	11	TA391	O	11
SE224	B,B	12,30	TA138	P	11	TA392	O	11
SE600	E	13	TA140	O	2	TA393	O	11
SE870	E	6	TA143	O	2	TA394	O	11
SEP04	B	11	TA155	P	3	TA395	O	11
SEP05	B	11	TA156	P	3	TA401	S	38
SEP06	B	11	TA167	N	8	TA406	O	8
SEP07	B	11	TA168	N	8	TA41	O	9
SEP08	B	11	TA171	Q	3	TA416	S,S	7,19
SEP10	B	11	TA183	I	20	TA418	S	7
SEP11	B	11	TA185	I	20	TA419	S	6
SEP12	B	11	TA194	N	5	TA422	S,S,S,S	
SEP14	B	11	TA199	N	5	TA427	S	25
SEP16	B	11	TA221	O	3	TA4301	S,S,S	16,20,37
SEP18	B	11	TA2210	D,O	18,3	TA433	S,S,S,S	9,16,20,
SEP20	B	11	TA2212	D,O	18,3	TA4413	S	33
SR110	E	21	TA224	O	3	TA4431	S	33
SR1212	E	21	TA226	D,O	18,3	TA445	S	24
SR1412	E	21	TA228	D,O	18,3	TA466	S	12
SR3812	E	21	TA261	O	3	TA467	S	13
SR80	E	21	TA30	P	6	TA471	S	34
T4304	E	15	TA324	O	2	TA493	S	20
T4305	E	15	TA327	N	5	TA541	S,S	10,24
T4306	E	15	TA328	L	6	TA548	S	28
T4307	E	15	TA330	P	5	TA551	S,S	27,34
T4308	E	15	TA334	P	5	TA553	S,S,S,S,S	3,13,27,34
T4310	E	15	TA335	P	5	TA559	S,S	26,36
T4312	E	15	TA338	P	5	TA569	E	14
T4405	E	15	TA3515	P	7	TA570	E	10
T4406	E	15	TA355	O	18	TA571	E	10

Part No.	Section	Page No.	Part No.	Section	Page No.	Part No.	Section	Page No.
TA574	P	4	TA7450	I	15	TA860	R	4
TA575	P	4	TA751	P	10	TA871	P	13
TA579	O	20	TA752	S	38	TA880	P	13
TA61	J	5	TA76	S	38	TA886	P	13
TA618	J	5	TA762	P	10	TA898	P	12
TA620	J	5	TA763	P	9	TA899	P	13
TA624	J	7	TA764	P	9	TA900	O	2
TA627	I	7	TA765	P	12	TA901	O	22
TA630	Q	6	TA767	D	14	TA902	O	22
TA635	Q	3	TA768	D	14	TA903	O	22
TA6373	Q	2	TA769	D	14	TA904	O	6
TA64	Q	3	TA770	P	12	TA907	O	22
TA649	Q	6	TA774	O	20	TA908	O	6
TA65	E	25	TA775	O	20	TA909	O	6
TA651	E	25	TA776	O	21	TA918	O	11
TA652	E	26	TA778	O	21	TA92	H	4
TA657	R	8	TA779	O	21	TA921	O	6
TA65R	E	25	TA780	E	9	TA924	E	8
TA66	E	26	TA780R	E	9	TA927	E	8
TA660	N	6	TA781	E	19	TA928	E	8
TA661	N	6	TA782	E	19	TA930	E	8
TA662	N	6	TA783	E	19	TA932	E	8
TA663	N	6	TA784	E	19	TA933	E	8
TA666	E	26	TA789	E	19	TA936	E	8
TA668	Q	4	TA801	E	4	TA938	E	8
TA669	J	3	TA8015	E	2	TA965	E	19
TA670	J	4	TA8016	E	3	TA971	P	3
TA671	J	3	TA8017	E	4	TA972	P	3
TA675	J	4	TA803	E	5	TA973	P	3
TA6770	J	4	TA804	E	3	TA974	P	2
TA6771	J	4	TA807	E	7	TA977	P	6
TA679	J	4	TA808	E	8	TA979	P	6
TA701	E	12	TA809	E	7	TA985	P	2
TA714	E	10	TA810	E	8	TH1414	J	7
TA716	E	11	TA814	E	6	TH1616	J	7
TA719	E	11	TA819	E	7	TH212	J	8
TA720	B,E	48,9	TA821	E	7	TH214	J	8
TA720R	E	9	TA824	E	7	TH216	J	8
TA722	E	18	TA826	E	7	TH312	J	8
TA723	E	18	TA827	E	7	TH314	J	8
TA724	E	18	TA828	E	7	TH316	J	8
TA725	E	18	TA830	E	7	TH712	J	9
TA726	O	6	TA832	E	7	TH714	J	9
TA727	O	6	TA833	E	7	TH716	J	9
TA731	O,O,	6,22	TA836	E	7	TH953	J	9
TA734	O	6	TA838	E	7	TH954	J	9
TA736	E	18	TA844	E	7	TH957	J	9
TA745	I	14	TA855	D,J	13,12	TIH10	B	41

Part No.	Section	Page No.	Part No.	Section	Page No.	Part No.	Section	Page No.
TIH11	B	41	TP120	E	16	TS209	B	10
TIH12	B	41	TP125	E	16	TS20L	B	20
TIH13	B	41	TP127	E	16	TS20Y	B	21
TIH14	B	41	TP130	E	16	TS210	B	10
TIH17	B	41	TP138	B,E	49,15	TS215	B	10
TIH19	B	41	TP140	E	16	TS220	B	10
TIS100	B	42	TP145	E	16	TS225	B	10
TIS50	B	42	TP150	E	16	TS227	B	10
TIS55	B	42	TP155	E	16	TS230	B	10
TIS60	B	42	TP214	B	49	TS240	B	10
TIS70	B	42	TP238	B	49	TS25	B	20
TIS80	B	42	TP312	B,E	49,15	TS25L	B	20
TIS90	B	42	TP320	E	16	TS25Y	B	21
TK4CS1	A	9	TP325	E	16	TS27	B	20
TK4DM1	A	21	TP327	E	16	TS27Y	B	21
TK4R1	A	17	TP330	E	16	TS30	B	20
TK4R2	A	17	TP340	E	16	TS30L	B	20
TK4R3	A	17	TP345	E	16	TS30Y	B	21
TK4R3A	A	17	TP350	E	16	TS40	B	20
TK4R4	A	18	TP355	E	16	TS40L	B	20
TK4R4A	A	18	TP400	G	7	TS40Y	B	21
TK4R5	A	18	TP500	G	7	TS420	E	16
TK4R5A	A	18	TP6MAG	B	49	TS425	E	16
TK4R6	A	19	TP6QRM	B	49	TS430	E	16
TK4R6A	A	19	TP960	G	10	TS440	E	16
TK4R7	A	19	TP980	G	12	TS445	E	16
TK4R7A	A	19	TP990	G	12	TS45	B	20
TK4R8	A	19	TS010	B	19	TS450	E	16
TK4R8A	A	19	TS015	B	19	TS455	E	16
TK4RM1	A	17	TS020	B	19	TS45L	B	20
TK4RS1	A	7	TS025	B	19	TS45Y	B	21
TK4T0	A	13	TS027	B	19	TS460	E	16
TK4T1	A	13	TS030	B	19	TS47	B	20
TK4T1A	A	13	TS040	B	19	TS50	B	20
TK4T2	A	13	TS045	B	19	TS50L	B	20
TK4T2A	A	14	TS050	B	19	TS50Y	B	21
TK4T3	A	14	TS055	B	19	TS520	E	15
TK4T3A	A	14	TS10	B	20	TS525	E	15
TK4T4	A	15	TS100	E	16	TS530	E	15
TK4T4A	A	15	TS110	B	9	TS540	E	15
TK4T5	A	15	TS115	B	9	TS545	E	15
TK4T5A	A	15	TS120	B	9	TS55	B	20
TK4TM1	A	13	TS125	B	9	TS550	E	15
TK4TS1	A	5	TS127	B	9	TS555	E	15
TK7200	A	11	TS130	B	9	TS55LL	B	20
TK7201	A	11	TS140	B	9	TS55Y	B	21
TP100	E	16	TS15	B	20	TS560	E	15
TP114	B	49	TS20	B	20	TSL100	B	31

Part No.	Section	Page No.	Part No.	Section	Page No.	Part No.	Section	Page No.
TSL55	B	31	V17005	G	3	VS5	H	9
TSL60	B	31	V17010	G	3	VS7	H	9
TSL70	B	31	V17015	G	3	XB710	E	5
TSL80	B	31	V17050	G	3	XB711	E	5
TSL90	B	31	V17052	G	3	XB712	E	5
TSP1	E	13	V17054	G	3	XB713	E	5
TST20	B	22	V18260	G	3	XB714	E	5
TST20L	B	23	V18262	G	3	XB715	E	5
TST25	B	22	V18264	G	3	XB716	E	5
TST25L	B	23	V18266	G	3	XB717	E	5
TST27	B	22	V18268	G	3	XB718	E	5
TST27L	B	23	V18270	G	3	XB719	E	5
TST30	B	22	V18272	G	3	XB721	E	5
TST30L	B	23	V18274	G	3	XB722	E	5
TST40	B	22	V24400	G	4	XB724	E	5
TST40L	B	23	V24401	G	4	XB727	E	5
TST45	B	22	V24402	G	4	XB730	E	5
TST45L	B	23	V24403	G	4	XB732	E	5
TST50	B	22	V24404	G	4	XB819	O	7
TST50L	B	23	V24405	G	4	XF016	B	10
TST55	B	22	V28000	G	3	XF020	B	10
TST55L	B	23	V28001	G	3	XF027	B	9
TSTL20	B	22	V28002	G	3	XF1013	B	7
TSTL25	B	22	V28003	G	3	XF1020	B	3
TSTL27	B	22	V28004	G	3	XF1027	B	3
TSTL30	B	22	V28005	G	3	XF104	B	7
TSTL40	B	22	V28008	G	3	XF1045	B	7
TSTL45	B	22	V28010	G	3	XF105	B	7
TSTL50	B	22	V28012	G	3	XF1051	B	4
TSTL55	B	22	V28013	G	3	XF1055	B	7
TX20BO	E	13	V28015	G	3	XF1059	B	4
TX25BO	E	13	V28020	G	3	XF106	B	7
TX27BO	E	13	V38257	G	4	XF107	B	7
TX30BO	E	13	V38258	G	4	XF108	B	7
TX40BO	E	13	V38259	G	4	XF109	B	7
TX45BO	E	13	V38260	G	4	XF110	B	7
TX50BO	E	13	V38261	G	4	XF111	B	7
TX55BO	E	13	V38262	G	4	XF112	B	7
TX702	G	10	V38263	G	4	XF113	B	7
V08060	G	2	V38264	G	4	XF114	B	7
V09310	G	2	V38265	G	4	XF1203	B	44
V09313	G	2	V38266	G	4	XF1208	B	45
V09315	G	2	V38270	G	4	XF1209	B	45
V09319	G	2	V47735	G	2	XF1265	B	53
V10001	G	2	V73593	G	12	XF1275	B	54
V10004	G	2	V73599	G	12	XF1293	B	47
V10007	G	2	VS10	H	9	XF1295	B	54
V10010	G	2	VS4	H	9	XF1403	B	44

Part No.	Section	Page No.	Part No.	Section	Page No.	Part No.	Section	Page No.
XF1408	B	45	XF3L08	B	13	XF519	B	15
XF1409	B	45	XF3L09	B	13	XF520	B	15
XF1466	B	50	XF3L10	B	13	XF521	B	15
XF1476	B	51	XF3L11	B	13	XF522	B	15
XF1493	B	47	XF3L12	B	13	XF524	B	15
XF1496	B	51	XF3L13	B	13	XF5506	B	15
XF179	B	2	XF3L14	B	13	XF5507	B	15
XF2010	B	8	XF3L15	B	13	XF5508	B	15
XF204	B	8	XF3L16	B	13	XF5509	B	15
XF205	B	8	XF3L17	B	13	XF5510	B	15
XF206	B	8	XF3L18	B	13	XF5511	B	15
XF207	B	8	XF3L19	B	13	XF5512	B	15
XF208	B	8	XF4012	B	14	XF5513	B	15
XF209	B	8	XF4019	B	14	XF5514	B	15
XF210	B	8	XF406	B	14	XF5515	B	15
XF211	B	8	XF407	B	14	XF5516	B	15
XF212	B	8	XF408	B	14	XF5517	B	15
XF213	B	8	XF409	B	14	XF5518	B	15
XF3018	B	13	XF410	B	14	XF5519	B	15
XF3023	B	5	XF411	B	14	XF5520	B	15
XF3038	B	5	XF412	B	14	XF5521	B	15
XF306	B	13	XF413	B	14	XF5522	B	15
XF307	B	13	XF414	B	14	XF5523	B	15
XF308	B	13	XF415	B	14	XF5524	B	15
XF309	B	13	XF416	B	14	XF6017	B	28
XF310	B	13	XF417	B	14	XF6027	B	6
XF311	B	13	XF418	B	14	XF610	B	28
XF312	B	13	XF419	B	14	XF611	B	28
XF313	B	13	XF420	B	14	XF612	B	28
XF314	B	13	XF421	B	14	XF613	B	28
XF315	B	13	XF422	B	14	XF614	B	28
XF316	B	13	XF423	B	14	XF615	B	28
XF317	B	13	XF424	B	14	XF616	B	28
XF318	B	13	XF5018	B	15	XF617	B	28
XF319	B	13	XF5019	B	15	XF618	B	28
XF320	B	13	XF506	B	15	XF619	B	28
XF321	B	13	XF507	B	15	XF620	B	28
XF322	B	13	XF508	B	15	XF621	B	28
XF324	B	13	XF509	B	15	XF622	B	28
XF3415	B	43	XF510	B	15	XF624	B	28
XF3421	B	6	XF511	B	15	XF627	B	28
XF3803	B	44	XF512	B	15	XF630	B	28
XF3808	B	45	XF513	B	15	XF632	B	28
XF3809	B	45	XF514	B	15	XF7013	B	28
XF3865	B	52	XF515	B	15	XF710	B	28
XF3875	B	52	XF516	B	15	XF711	B	28
XF3893	B	47	XF517	B	15	XF712	B	28
XF3895	B	53	XF518	B	15	XF713	B	28
Part No.	Section	Page No.	Part No.	Section	Page No.	Part No.	Section	Page No.

Part No.	Section	Page No.	Part No.	Section	Page No.	Part No.	Section	Page No.
XF714	B	28	XFB18	B	34	XFI521	B	38
XF715	B	28	XFB19	B	34	XFI522	B	38
XF716	B	28	XFBH9	B	18	XFI5LP	B	38
XF717	B	28	XFDP18	B	27	XFI608	B	39
XF718	B	28	XFE14	B	12	XFI609	B	39
XF719	B	28	XFE200	B	30	XFI610	B	39
XF721	B	28	XFEL14	B	12	XFI611	B	39
XF722	B	28	XFH09	B	17	XFI612	B	39
XF724	B	28	XFH11	B	30	XFI613	B	39
XF8023	B	29	XFHL8	B	31	XFI614	B	39
XF808	B	29	XFHL9	B	17	XFI615	B	39
XF809	B	29	XFI200	B	37	XFI616	B	39
XF810	B	29	XFI300	B	37	XFI617	B	39
XF811	B	29	XFI312	B	37	XFI618	B	39
XF812	B	29	XFI314	B	37	XFI619	B	39
XF813	B	29	XFI338	B	37	XFI621	B	39
XF814	B	29	XFI410	B	38	XFI622	B	39
XF815	B	29	XFI411	B	38	XFI6SD	B	39
XF816	B	29	XFI412	B	38	XFI710	B	39
XF817	B	29	XFI413	B	38	XFI711	B	39
XF818	B	29	XFI414	B	38	XFI712	B	39
XF819	B	29	XFI415	B	38	XFI713	B	39
XF820	B	29	XFI416	B	38	XFI714	B	39
XF821	B	29	XFI417	B	38	XFI715	B	39
XF822	B	29	XFI418	B	38	XFI716	B	39
XF823	B	29	XFI419	B	38	XFI717	B	40
XF824	B	29	XFI421	B	38	XFI718	B	40
XF825	B	29	XFI422	B	38	XFI719	B	40
XF826	B	29	XFI423	B	38	XFI721	B	40
XF827	B	29	XFI424	B	38	XFI722	B	40
XF828	B	29	XFI427	B	38	XFI723	B	40
XF830	B	29	XFI430	B	38	XFI724	B	40
XF832	B	29	XFI432	B	38	XFI727	B	40
XFA100	B	48	XFI4LP	B	38	XFI7SD	B	39
XFA16	B	49	XFI506	B	38	XFI8SD	B	40
XFA200	B	48	XFI507	B	38	XFIH10	B	40
XFAS3	B	33	XFI508	B	38	XFIH7	B	41
XFAS4	B	33	XFI509	B	38	XFIS10	B	41
XFAS6	B	34	XFI510	B	38	XFIS7	B	42
XFB010	B	34	XFI511	B	38	XFIX4	B	42
XFB08	B	34	XFI512	B	38	XFL12	B	13
XFB10	B	34	XFI513	B	38	XFL13	B	7
XFB12	B	34	XFI514	B	38	XFLH9	B	16
XFB13	B	34	XFI515	B	38	XFLM13	B	8
XFB14	B	34	XFI516	B	38	XFLO24	B	27
XFB15	B	34	XFI517	B	38	XFLO27	B	27
XFB16	B	34	XFI518	B	38	XFLO29	B	27
XFB17	B	34	XFI519	B	38	XFLO30	B	27
Part No.	Section	Page No.	Part No.	Section	Page No.	Part No.	Section	Page No.



Part No.	Section	Page No.	Part No.	Section	Page No.	Part No.	Section	Page No.
XFLO32	B	27	XFM813	B	29	XFTS8	B	22
XFLO36	B	27	XFM814	B	29	XFTSL8	B	21
XFLO38	B	27	XFM815	B	29	XFTSP7	B	11
XFLO7	B	27	XFM816	B	29	XFWE10	B	50
XFLR10	B	23	XFM817	B	29	XFXL4	B	32
XFLS10	B	19	XFM818	B	29	XFXL6	B	32
XFLTS8	B	22	XFM819	B	29	XFXL7	B	25
XFLX7	B	25	XFM820	B	29	XFXS7	B	26
XFM104	B	9	XFM821	B	29	XFYBH9	B	19
XFM105	B	9	XFM822	B	29	XFYH9	B	18
XFM106	B	9	XFM823	B	29	XFYS8	B	21
XFM107	B	9	XFM824	B	29	XL1001	E	14
XFM108	B	9	XFM825	B	29	XL1008	E	14
XFM109	B	9	XFM826	B	29	XL1016	E	14
XFM110	B	9	XFM827	B	29	XL1021	E	14
XFM111	B	9	XFM828	B	29	XL3404	B	6
XFM112	B	9	XFM830	B	29	XL3408	B	6
XFM113	B	9	XFM832	B	29	XL3416	B	6
XFM114	B	9	XFPE12	B	11	XL3418	B	6
XFM13	B	9	XFR190	B	43	XL3419	B,B	6,43
XFM145	B	9	XFR290	B	44	XL3421	B,B	6,43
XFM155	B	9	XFR372	B	44	XL3422	B,B	6,43
XFM19	B	16	XFR390	B	44	XL3423	B,B	6,43
XFM23	B	29	XFR3E	B	45	XL3424	B,B	6,43
XFM306	B	16	XFR3F	B	45	XL3426	B,B	6,43
XFM307	B	16	XFR490	B	44	XL3427	B,B	6,43
XFM308	B	16	XFRF12	B	46	XL3428	B,B	6,43
XFM309	B	16	XFRF14	B	46	XL3429	B,B	6,43
XFM310	B	16	XFRF2	B	46	XL3430	B,B	6,43
XFM311	B	16	XFRF3	B	46	XL3432	B,B	6,43
XFM312	B	16	XFRF38	B	46	XL3433	B,B	6,43
XFM313	B	16	XFRL8	B	24	XL3435	B,B	6,43
XFM314	B	16	XFRP12	B	46	XL3436	B,B	6,43
XFM315	B	16	XFRP14	B	46	XL3438	B,B	6,43
XFM316	B	16	XFRP3	B	46	XL3441	B,B	6,43
XFM317	B	16	XFRP38	B	46	XL3446	B,B	6,43
XFM318	B	16	XFRR12	B	47	XL3450	B,B	6,43
XFM319	B	16	XFRR14	B	47	XL936	E	16
XFM320	B	16	XFRR38	B	47	XL941	E	16
XFM321	B	16	XFRS10	B	24	XL946	E	16
XFM322	B	16	XFRS12	B	47	XL950	E	16
XFM323	B	16	XFRS14	B	47	XL955	E	16
XFM324	B	16	XFRS38	B	47	XL960	E	16
XFM808	B	29	XFS10	B	20	XL965	E	16
XFM809	B	29	XFSD9	B	26	XL970	E	16
XFM810	B	29	XFSL6	B	31	XL975	E	16
XFM811	B	29	XFSL7	B	20	XL980	E	16
XFM812	B	29	XFSP9	B	21	XL996	E	16

Part No.	Section	Page No.
XLR123	B	47

Part No.	Section	Page No.
----------	---------	----------

# Mechanics Tool Guide

2020 Catalogue



Mechanics First Choice For 85 Years



**FRANKLIN**  
Professional Quality Tools

"One of our key design rules is to focus to provide a quicker solution that performs first time and lasts a lifetime"